

PJT Open Frame Power Supply

PJT-40W Series / PJT-□□V40WBA□

PJT

Highlights & Features

- Universal AC input voltage
- Standard industrial foot print of 2" x 3"
- Low leakage current < 0.1mA
- Convection cooled operating temperature range from -10°C to +70°C
- High MTBF > 700,000 hrs as per Telcordia SR-332
- Multiple connector source options

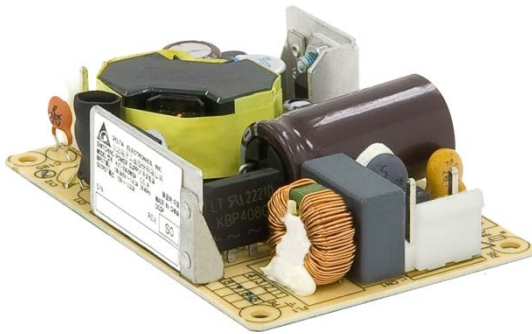

Safety Standards



CB Certified for worldwide use

Model Number: PJT-□□V40WBA□
Unit Weight: 0.08 kg (0.18 lb)
Dimensions (L x W x D): 76.2 x 50.8 x 22.9 mm [2" x 3"]

General Description

The PJT open frame power supply series offers choices of 12V, 15V, 18V and 24V nominal output voltages. The single output products are designed with small standard industrial foot prints at 2" x 3". The highly efficient convection cooling designs enable optimum thermal management for high power efficiency. The PJT series of products can operate from -10°C to +70°C across the entire input voltage range of 90 to 264Vac and are certified for safety standard according to IEC/EN/UL 60950-1 and for EMI standard according to EN 55022, Class B.

Model Information

PJT Open Frame Power Supply

Model Number	Input Voltage Range	Rated Output Voltage	Rated Output Current
PJT-12V40WBA□	90-264Vac	12Vdc	3.33A
PJT-15V40WBA□		15Vdc	2.67A
PJT-18V40WBA□		18Vdc	2.22A
PJT-24V40WBA□		24Vdc	1.66A

Model Numbering

PJ	T –	XXV	40W	B	A	□
Open Frame	Product Type T – ITE Application Series	Output Voltage 12V 15V 18V 24V	Output Power	Package Type B – Open Frame	Family Code A	Harness Connector A – JST connector B – Molex connector* C – JWT connector*

*Options

PJT Open Frame Power Supply

PJT-40W Series / PJT-□□V40WBA□

Specifications

	Model Number	PJT-12V40WBA□	PJT-15V40WBA□	PJT-18V40WBA□	PJT-24V40WBA□
--	--------------	---------------	---------------	---------------	---------------

Input Ratings / Characteristics

Nominal Input Voltage	100-240Vac				
Input Voltage Range	90-264Vac				
Nominal Input Frequency	50-60Hz				
Input Frequency Range	47-63Hz				
Input Current	< 0.85A typ. @ 115Vac				
Efficiency at 100% Load	115Vac	85.0% typ.	86.0% typ.	86.0% typ.	86.0% typ.
	230Vac	86.0% typ.	87.0% typ.		87.0% typ.
Max Inrush Current (Cold Start)	30A typ. @ 115Vac, 60A typ. @ 230Vac				
Leakage Current	0.1mA @ 240Vac				

Output Ratings / Characteristics

Nominal Output Voltage		12Vdc	15Vdc	18Vdc	24Vdc
Factory Set Point Tolerance	No potentiometer (± 5%)				
Output Current		3.33A	2.67A	2.22A	1.66A
Output Power	40W				
Line Regulation	± 0.5% @ 115Vac & 230Vac				
Load Regulation	± 1.0% @ 115Vac & 230Vac				
PARD* (20MHz)		< 120mVpp	< 150mVpp	< 180mVpp	< 240mVpp
Start-up Time	115Vac	2800ms typ. (100% load)			
	230Vac	1100ms typ. (100% load)			
Hold-up Time	115Vac	18ms typ. (100% load)			
	230Vac	90ms typ. (100% load)			
Dynamic Response (Overshoot & Undershoot O/P Voltage)	± 5% @ 50-100% load (Slew Rate: 0.1A/μS)				
Start-up with Capacitive Loads		4,000uF Max	3,500uF Max	3,000uF Max	2,000uF Max

*PARD is measured with an AC coupling mode, 5cm wires, and in parallel with 0.1μF ceramic capacitor & 47μF electrolytic capacitor.

Mechanical

Dimensions	76.2 x 50.8 x 22.9 mm [2" x 3"]				
Unit Weight	0.08 kg (0.18 lb)				
Cooling System	Convection				
Power Supply Header	PJT-□□V40WBAA	Input: JST B2P3-VH (LF)(SN) Output: JST B4P-VH (LF)(SN)			
	PJT-□□V40WBAB	Input: Molex 26-62-4030 Output: Molex 26-60-4040			
	PJT-□□V40WBAC	Input: JWT A3963WV2-3P-D Output: JWT A3963WV2-4P			
Wire	AWG 22-18				

PJT Open Frame Power Supply

PJT-40W Series / PJT-□□V40WBA□

Environment

Surrounding Air Temperature	Operating	-10°C to +70°C
	Storage	-40°C to +85°C
Power De-rating	> 50°C de-rate power by 2.5% / °C	
Operating Humidity	10 to 95% RH (Non-Condensing)	
Operating Altitude	0 to 5,000 Meters (16,400 ft.)	
Shock Test (Non-Operating)	IEC 60068-2-27, Half Sine Wave: 50G for a duration of 11ms, 3 shocks for each 3 directions	
Vibration (Operating)	IEC 60068-2-6, Sine Wave: 10Hz to 150Hz @ 25m/S ² (2.5G); 10 min per cycle, 90 min per axis for all X, Y, Z direction	

Protections

Overvoltage	13.2-18.0V, Latch Mode	16.5-22.5V, Latch Mode	19.8-27.0V, Latch Mode	26.4-36.0V, Latch Mode
Overload / Overcurrent	> 140% of rated load current, Hiccup Mode, Non-Latching (Auto-Recovery)			
Over Temperature	Non-Latching (Auto-Recovery)			
Short Circuit	Hiccup Mode, Non-Latching (Auto-Recovery when the fault is removed)			
Protection Against Shock	Class I with PE* connection			

*PE: Primary Earth

Reliability Data

MTBF	> 700,000 hrs. as per Telcordia SR-332
Expected Cap Life Time	10 years (115Vac & 230Vac, 50% load @ 40°C)

Safety Standards / Directives

Electrical Safety	TUV Bauart UL/cUL recognized CB scheme	EN 60950-1 UL 60950-1 and CSA C22.2 No. 60950-1 (File No. E131881) IEC 60950-1
CE	In conformance with EMC Directive 2004/108/EC and Low Voltage Directive 2006/95/EC	
Material and Parts	RoHS Directive 2011/65/EU Compliant	
Galvanic Isolation	Input to Output	3.0KVac
	Input to Ground	2.0KVac
	Output to Ground	0.5KVac

PJT Open Frame Power Supply

PJT-40W Series / PJT-□□V40WBA□

EMC

EMC / Emissions	CISPR 22, EN 55022, FCC Title 47: Class B		
Immunity to	EN 55024		
Electrostatic Discharge	IEC 61000-4-2	Criteria A ¹⁾ Level 3 Air Discharge: 8kV Level 3 Contact Discharge: 6kV	
Radiated Field	IEC 61000-4-3	Level 2 Criteria A ¹⁾ 80MHz-1GHz, 3V/M with 1kHz tone / 80% modulation	
Electrical Fast Transient / Burst	IEC 61000-4-4	Level 3 Criteria A ¹⁾ 2kV	
Surge	IEC 61000-4-5	Level 3 Criteria A ¹⁾ Common Mode ²⁾ : 2kV Differential Mode ³⁾ : 1kV	
Conducted	IEC 61000-4-6	Level 2 Criteria A ¹⁾ 3V with 80% AM	
Power Frequency Magnetic Fields	IEC 61000-4-8	Criteria A ¹⁾ Magnetic field strength 3A/Meter	
Voltage Dips	IEC 61000-4-11	30% dip; 10ms Criterion A 60% dip; 100ms Criterion B 95% dip; 5000ms Criterion B	
Voltage Fluctuation and Flicker	IEC/EN 61000-3-3		

- 1) Criteria A: Normal performance within the specification limits
- 2) Asymmetrical: Common mode (Line to earth)
- 3) Symmetrical: Differential mode (Line to line)

Block Diagram

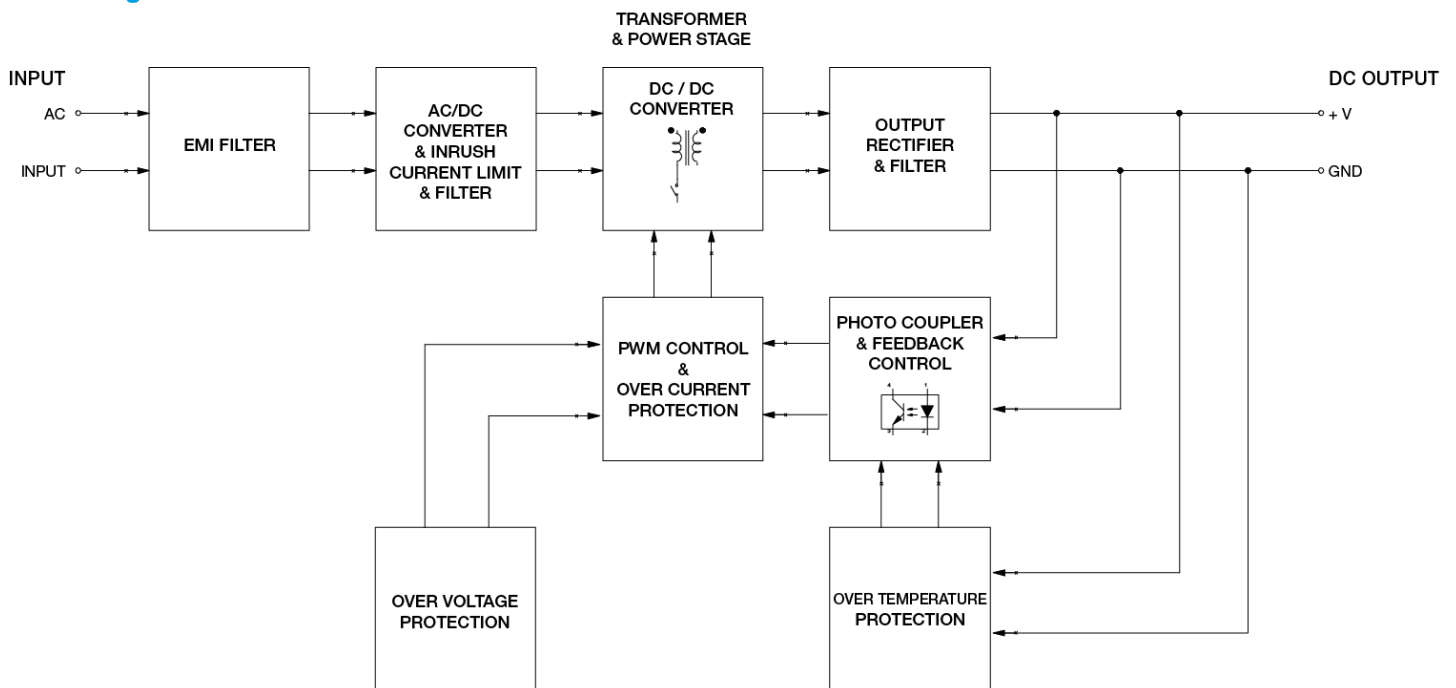

PJT Open Frame Power Supply

PJT-40W Series / PJT-□□V40WBA□

Dimensions

L x W x D: 76.2 x 50.8 x 22.9 mm [2" x 3"]

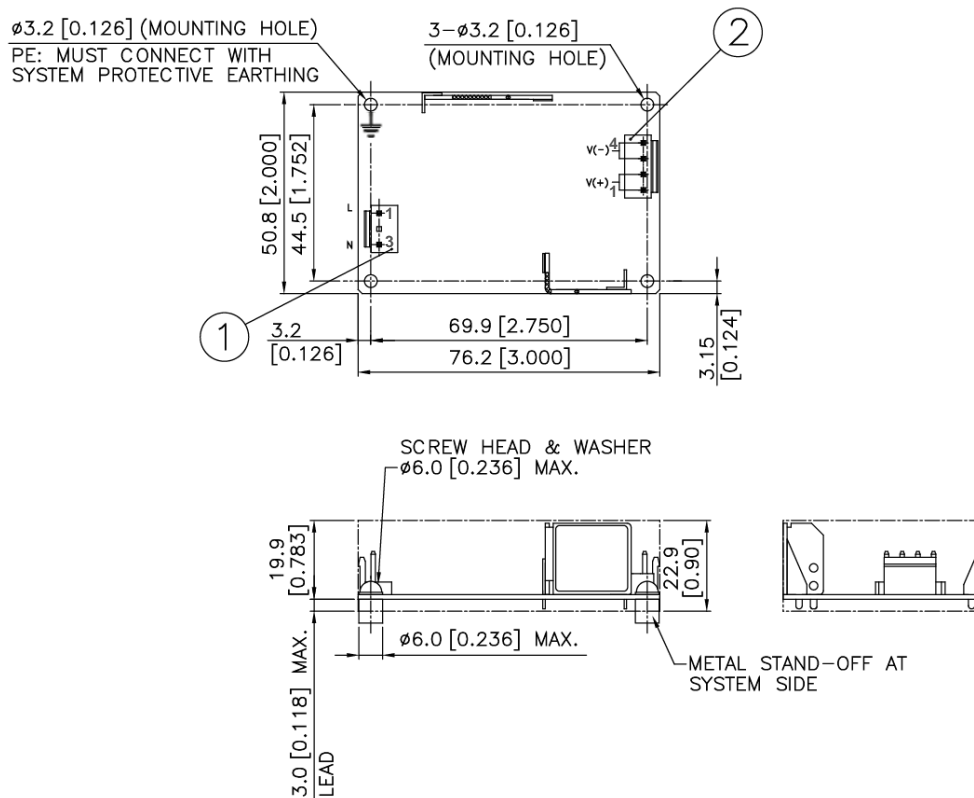

Item	Device Description
1	Input Connector (CN1) Pin 1: Line Pin 2: NC Pin 3: Neutral
2	Output Connector (CN2) Pin 1 to 2 : V(+) Pin 3 to 4 : V(-)

PJT Open Frame Power Supply

PJT-40W Series / PJT-□□V40WBA□

Engineering Data

Output Load De-rating VS Surrounding Air Temperature

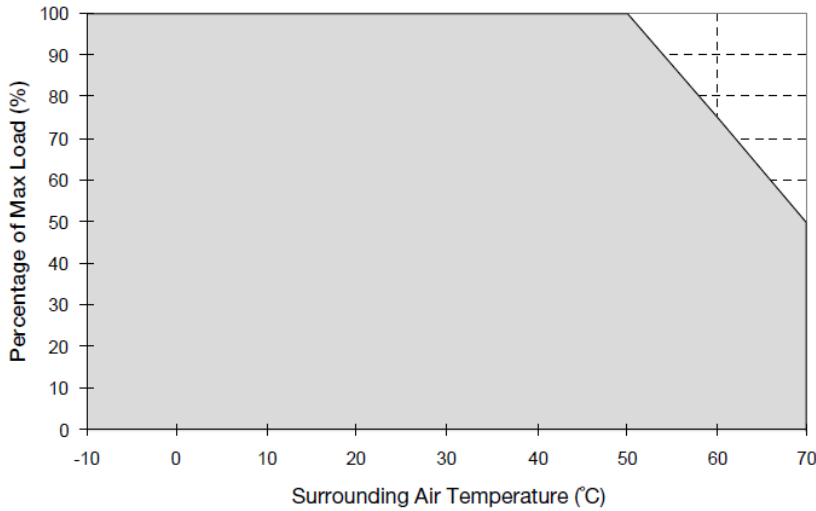
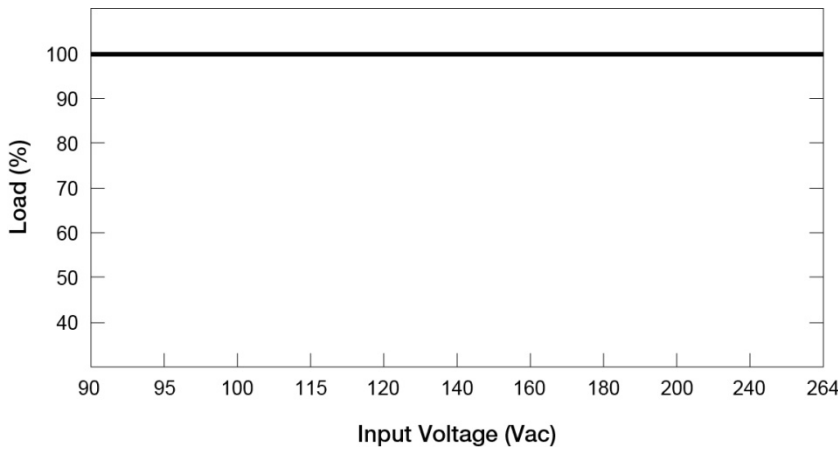

Fig. 1 De-rating for Horizontal Mounting Orientation
 > 50°C de-rate power by 2.5% / °C

Note

1. Power supply components may degrade, or be damaged, when the power supply is continuously used outside the shaded region, refer to the graph shown in Fig. 1.
2. If the output capacity is not reduced when the surrounding air temperature >50°C, the device will run into Over Temperature Protection. When activated, the output voltage will go into bouncing mode and will recover when the surrounding air temperature is lowered or the load is reduced as far as necessary to keep the device in working condition.
3. Depending on the surrounding air temperature and output load delivered by the power supply, the device can be very hot!
4. If the device has to be mounted in any other orientation, please contact info@deltapsu.com for more details.

Output Load De-rating VS Input Voltage



- No output power de-rating for the input voltage from 90Vac to 264Vac

PJT Open Frame Power Supply

PJT-40W Series / PJT-□□V40WBA□

Assembly & Installation

Any excessive twisting or bending may damage the device's PCB. Please handle the device with care.

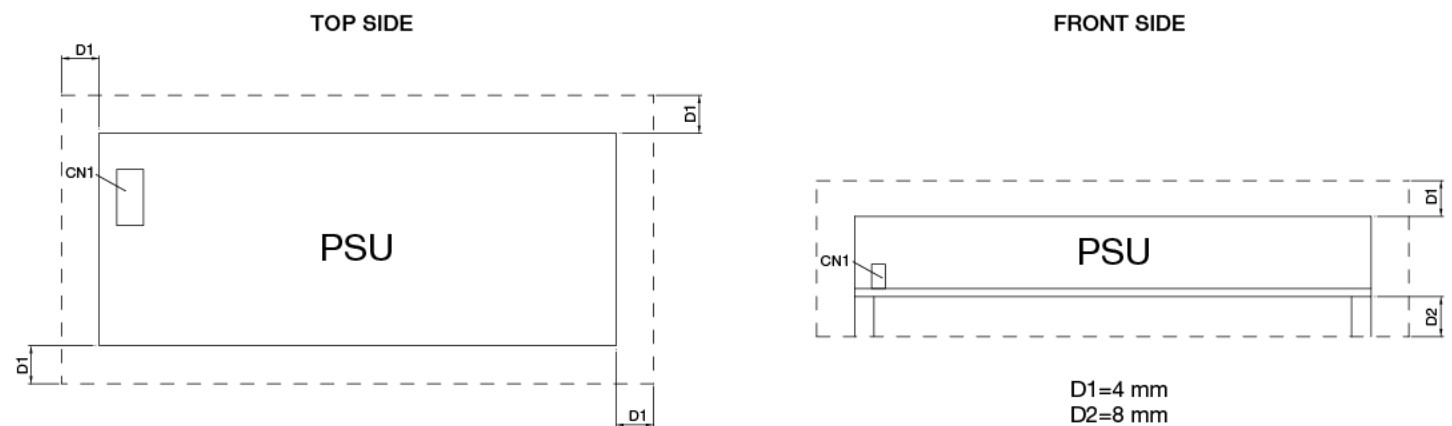
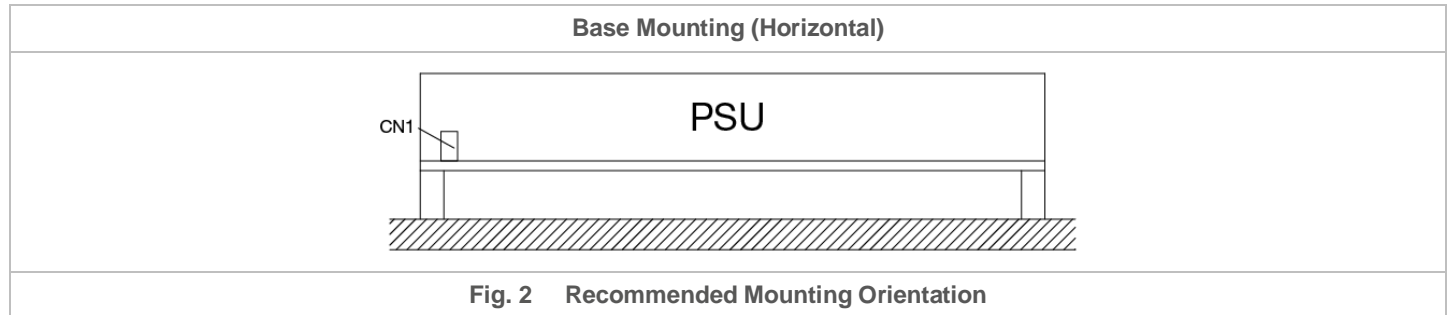

Use cable of AWG No. 22-18. Please refer to Table 1 for the recommended Mating Connector and Terminal.

Table 1	Input / Output	Power Supply Header	Mating Connector	Terminal
A – JST connector	Input	B2P3-VH (LF)(SN)	VHR-3N	SVH-21T-P1.1
	Output	B4P-VH (LF)(SN)	VHR-4N	SVH-21T-P1.1
B – Molex connector	Input	26-62-4030	09-50-3031	08-52-0071
	Output	26-60-4040	09-50-3041	08-52-0071
C – JWT connector	Input	A3963WV2-3P-D	A3963H02-3P	A3963TOP-2
	Output	A3963WV2-4P	A3963H02-4P	A3963TOP-2

Safety Instructions

- If the device has to be mounted in any other orientation, please contact info@deltapsu.com for more details.
- The device is not recommended to be placed on surface with low thermal conductivity, such as plastics, for example.
- For safety reasons, please ensure the mounted device is kept at $\geq 4\text{mm}$ (0.16 inch) safety distance at all sides from other components and equipments. Please insert an insulation sheet between the system and product, if the safety distance is less than 4mm. In addition, to ensure sufficient convection cooling, always maintain a distance of $\geq 20\text{mm}$ (0.79 inch) from ventilated surfaces while the device is in operation.
- Note that the device can become very hot depending on the ambient temperature and load of the power supply. Do not touch the device while it is in operation or immediately after power is turned OFF. Risk of burning!
- Do not touch the terminals while power is being supplied. Risk of electric shock.
- Prevent any foreign metal, particles or conductors from entering the device through the openings during installation. It may cause: Electric shock; Safety Hazard; Fire; Product failure
- The power supply must be mounted by metal screws onto a grounded metal surface. It is highly recommended that the Earth terminal on the connector be connected to the grounded metal surface.

PJT Open Frame Power Supply

PJT-40W Series / PJT-□□V40WBA□

Functions

Start-up Time

The time required for the output voltage to reach 90% of its final steady state set value, after the input voltage is applied.

Rise Time

The time required for the output voltage to change from 10% to 90% of its final steady state set value.

Hold-up Time

Time between the collapse of the AC input voltage, and the output falling to 95% of its steady state set value.

■ Graph illustrating the Start-up Time, Rise Time, and Hold-up Time

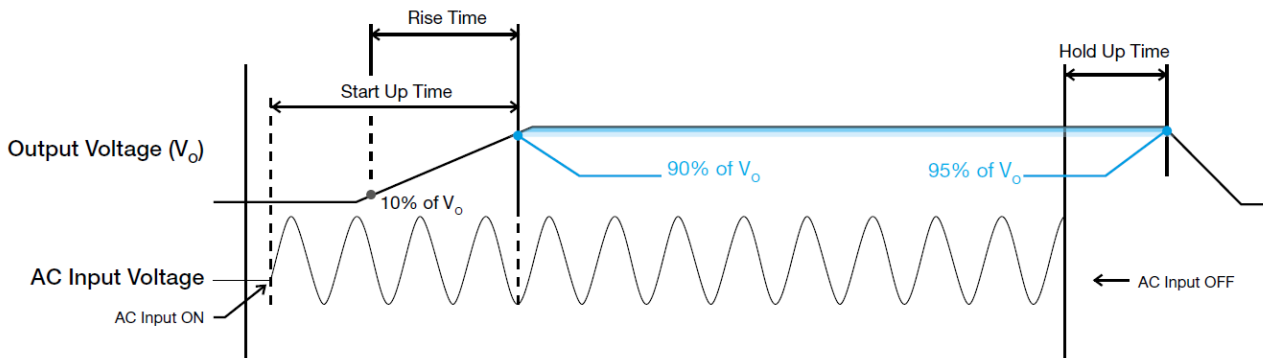

Inrush Current

Inrush current is the peak, instantaneous, input current measured and, occurs when the input voltage is first applied. For AC input voltages, the maximum peak value of inrush current will occur during the first half cycle of the applied AC voltage. This peak value decreases exponentially during subsequent cycles of AC voltage.

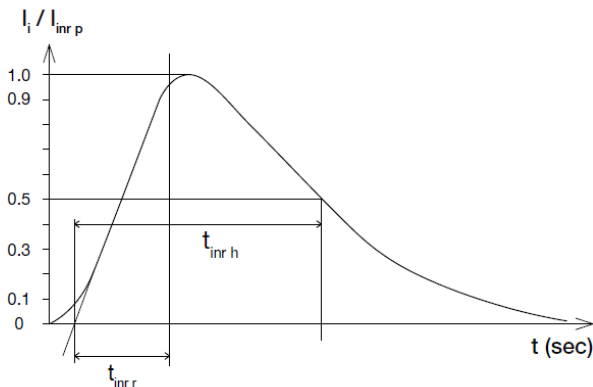

Dynamic Response

The power supply output voltage will remain within $\pm 5\%$ of its steady state value, when subjected to a dynamic load from 50 to 100% of its rated current.

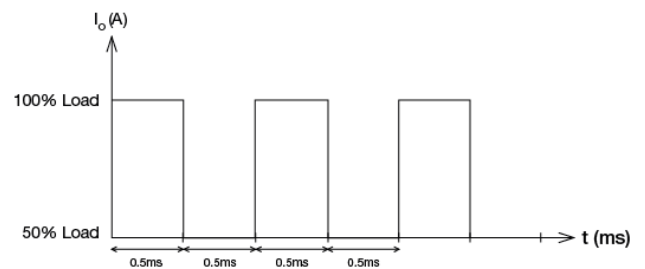

PJT Open Frame Power Supply

PJT-40W Series / PJT-□□V40WBA□

Overload & Overcurrent Protections (Auto-Recovery)

The power supply's Overload (OLP) and Overcurrent (OCP) Protections will be activated when output current exceeds 140% of I_O (Max load). In such occurrence, the V_O will start to droop and once the power supply has reached its maximum power limit, the protection is activated and the power supply will go into "Hiccup mode" (Auto-Recovery). The power supply will recover once the fault condition of the OLP and OCP is removed and I_O is back within the specifications.

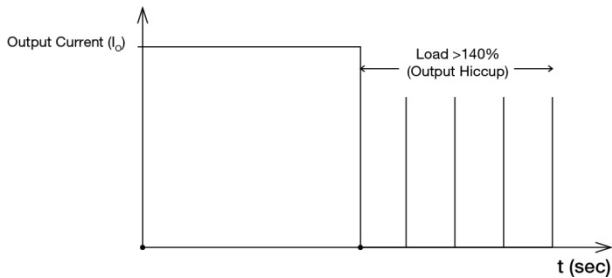

It is not recommended to prolong the duration of I_o when it is <140% but >100%, since it may cause damage to the PSU.

Short Circuit Protection (Auto-Recovery)

The power supply's output OLP/OCP function also provides protection against short circuits. When a short circuit is applied, the output current will operate in "Hiccup mode", as shown in the illustration in the OLP/OCP section on this page. The power supply will return to normal operation after the short circuit is removed.

Others

Delta RoHS Compliant



Restriction of the usage of hazardous substances

The European directive 2011/65/EU limits the maximum impurity level of homogeneous materials such as lead, mercury, cadmium, chrome, polybrominated flame retardants PBB and PBDE for the use in electrical and electronic equipment. RoHS is the abbreviation for "Restriction of the use of certain hazardous substances in electrical and electronic equipment".

This product conforms to this standard.

Overvoltage Protection (Latch Mode)

The power supply's overvoltage circuit will be activated when its internal feedback circuit fails. The output voltage shall not exceed its specifications defined on Page 3 under "Protections". Power supply will latch off, and require removal/re-application of input AC voltage in order to restart.

The power supply should be latch.

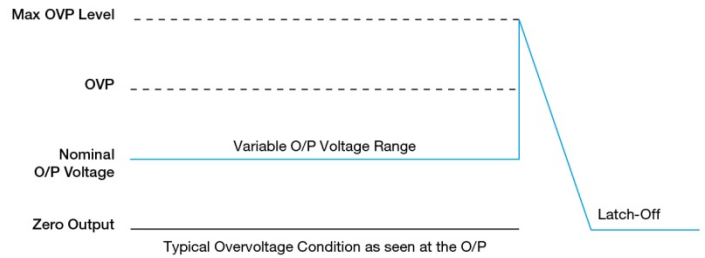

Over Temperature Protection (Auto-Recovery)

As described in load de-rating section, the power supply also has Over Temperature Protection (OTP). In the event of a higher operating temperature at 100% load, the power supply will run into OTP when the operating temperature is beyond what is recommended in the de-rating graph. When activated, the output voltage will go into bouncing mode until the temperature drops to its normal operating temperature as recommended in the de-rating graph.