

6A, 18V, 500kHz, ACOT™ Step-Down Converter

General Description

The RT6257A/B is a high-efficiency, monolithic synchronous step-down DC-DC converter that can deliver up to 6A output current from a 4.5V to 18V input supply. The RT6257A/B adopts ACOT architecture to allow the transient response to be improved and keep in constant frequency. Cycle-by-cycle current limit provides protection against shorted outputs and soft-start eliminates input current surge during start-up. Fault conditions also include output under voltage protection and thermal shutdown.

Ordering Information

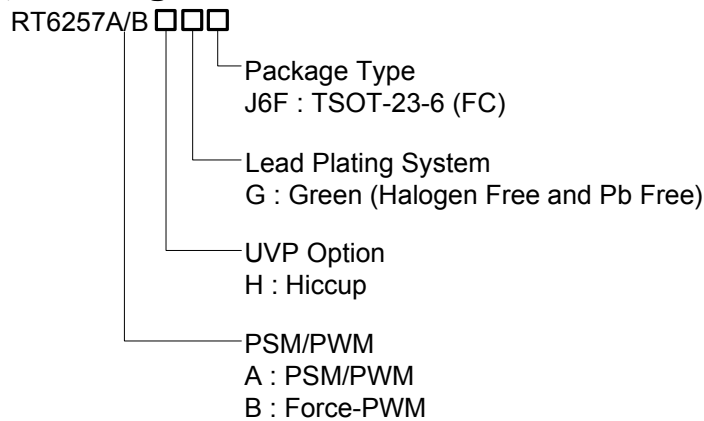

Note :

Richtek products are :

- ▶ RoHS compliant and compatible with the current requirements of IPC/JEDEC J-STD-020.
- ▶ Suitable for use in SnPb or Pb-free soldering processes.

Marking Information

RT6257AHGJ6F

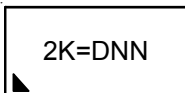

2K= : Product Code
DNN : Date Code

RT6257BHJ6F

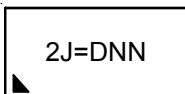

2J= : Product Code
DNN : Date Code

Features

- 4.5V to 18V Input Voltage Range
- 6A Output Current
- Constant-On-Time Mode to Enables Fast Transient Response
- Low Output Ripple and Allows Ceramic Output Capacitor
- 500kHz Switching Frequency
- High Efficient Internal Power MOSFET Switch Optimized for Lower Duty Cycle Applications
- Integrated 30mΩ/20mΩ MOSFETs
- Adjustable Output Voltage from 0.6V to 5V
- Internal Soft-Start (1.5ms typ.)
- Built-In UVP/OTP
- Input Under Voltage Lockout
- TSOT23-6 (FC) Package

Applications

- Set Top Box
- Portable TV
- Access Point Router
- DSL Modem
- LCD TV

Pin Configuration

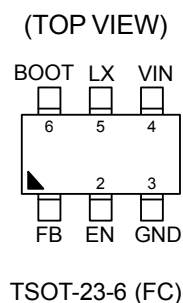

Typical Application Circuit

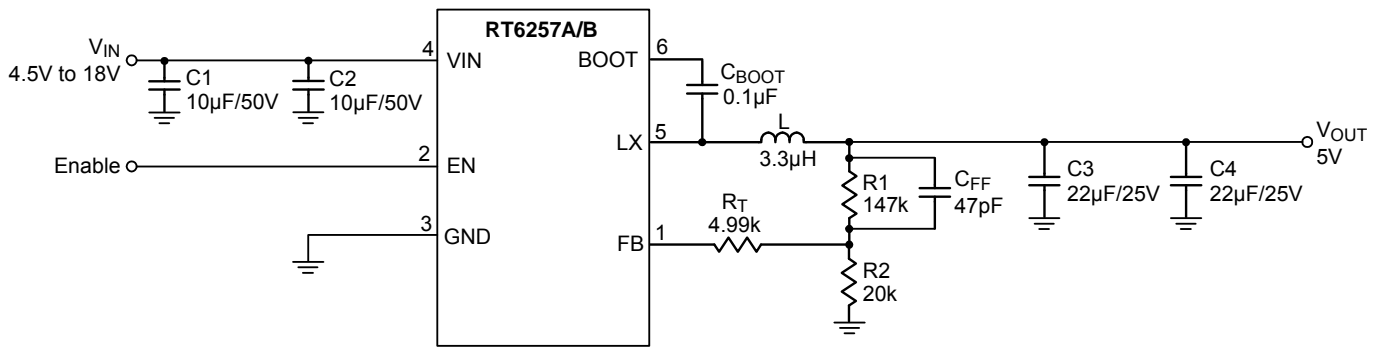

Table 1. Suggested Component Values

| V _{OUT} (V) | R ₁ (kΩ) | R ₂ (kΩ) | L (µH) | C _{OUT} (µF) | R _T (kΩ) | C _{FF} (pF) |
|----------------------|---------------------|---------------------|--------|-----------------------|---------------------|----------------------|
| 1 | 13.3 | 20 | 1.2 | 44 | 4.99 | -- |
| 1.2 | 20 | 20 | 1.2 | 44 | 4.99 | -- |
| 1.8 | 40.2 | 20 | 1.5 | 44 | 4.99 | -- |
| 2.5 | 63.4 | 20 | 2.2 | 44 | 4.99 | 47 to 82 |
| 3.3 | 90.9 | 20 | 2.8 | 44 | 4.99 | 47 to 82 |
| 5 | 147 | 20 | 3.3 | 44 | 4.99 | 47 to 82 |

Note :

- (1) All the input and output capacitors are the suggested values, referring to the effective capacitances, subject to any de-rating effect, like a DC bias.
- (2) Considering the noise immunity, it is necessary to add R_T = 4.99k between feedback network and chip FB pin.

Functional Pin Description

| Pin No. | Pin Name | Pin Function |
|---------|----------|--|
| 1 | FB | Feedback voltage input. This pin is used to set the desired output voltage via an external resistive divider. |
| 2 | EN | Enable control input. Connecting this pin to logic high can enable the device and connecting this pin to GND can disable the device. |
| 3 | GND | System ground. Provides the ground return path for the control circuitry and low-side power MOSFET. |
| 4 | VIN | Power input. Supplies the power switches of the device. |
| 5 | LX | Switch node. LX is the switching node that supplies power to the output and connect the output LC filter from LX to the output load. |
| 6 | BOOT | Bootstrap supply for high-side gate driver. Connect a 0.1µF ceramic capacitor from LX to BOOT to power the high-side switch. |

driver supply voltage for the high-side N-channel MOSFET switch.

Over-Temperature Protection

The RT6257A/B includes an Over-Temperature Protection (OTP) circuitry to prevent overheating due to excessive power dissipation. The OTP will shut down switching operation when the junction temperature exceeds 150°C. Once the junction temperature cools down by approximately 15°C, the IC will resume normal operation. For continuous operation, provide adequate cooling so that the junction temperature does not exceed 150°C.

UVP Protection

The RT6257A/B detects under-voltage conditions by monitoring the feedback voltage on FB pin. When the feedback voltage is lower than 60% of the target voltage, the UVP comparator will go high to turn off both internal high-side and low-side MOSFETs.

Absolute Maximum Ratings (Note 1)

- Supply Input Voltage and EN Voltage, V_{IN} , EN ----- -0.3V to 20V
- Switch Voltage, LX ----- -0.3V to 20V
- <20ns ----- -5V to 27V
- BOOT to LX, $V_{BOOT} - V_{LX}$ ----- -0.3V to 6V
- Other Pins ----- -0.3V to 6V
- Power Dissipation, P_D @ $T_A = 25^\circ C$
- TSOT-23-6 (FC) ----- 2.12W
- Package Thermal Resistance (Note 2)
- TSOT-23-6 (FC), θ_{JA} ----- $47^\circ C/W$
- TSOT-23-6 (FC), θ_{JC} ----- $2^\circ C/W$
- Junction Temperature ----- $150^\circ C$
- Lead Temperature (Soldering, 10 sec.) ----- $260^\circ C$
- Storage Temperature Range ----- $-65^\circ C$ to $150^\circ C$
- ESD Susceptibility (Note 3)
- HBM (Human Body Model) ----- 2kV

Recommended Operating Conditions (Note 4)

- Supply Input Voltage ----- 4.5V to 18V
- Junction Temperature Range ----- $-40^\circ C$ to $125^\circ C$
- Ambient Temperature Range ----- $-40^\circ C$ to $85^\circ C$

Electrical Characteristics

($V_{IN} = 12V$, $T_A = 25^\circ C$, unless otherwise specified)

| Parameter | Symbol | Conditions | Min | Typ | Max | Unit |
|--|-------------------|--|-----|-----|-----|---------|
| Supply Voltage | | | | | | |
| VIN Supply Input Operating Voltage | V_{IN} | | 4.5 | -- | 18 | V |
| VIN Under-Voltage Lockout Threshold-Rising | V_{UVLO} | V_{IN} rising | 3.9 | 4.1 | 4.3 | V |
| VIN Under-Voltage Lockout Threshold-Hysteresis | ΔV_{UVLO} | | -- | 0.3 | -- | V |
| Supply Current | | | | | | |
| Supply Current (Shutdown) | I_{SHDN} | $V_{EN} = 0$ | -- | 3 | -- | μA |
| Supply Current (Quiescent) | I_Q | $I_{OUT} = 0$ $V_{FB} = V_{REF} \times 105\%$, not switching | -- | 115 | -- | μA |
| Soft-Start | | | | | | |
| Soft-Start Time | tss | | -- | 1.5 | -- | ms |
| Enable Voltage | | | | | | |
| EN Input High Voltage | V_{EN_H} | | 1.5 | -- | -- | V |
| EN Input Low Voltage | V_{EN_L} | | -- | -- | 0.4 | V |

| Parameter | Symbol | Conditions | Min | Typ | Max | Unit | |
|--------------------------------------|-----------------|------------------------|----------------------------|-----|-------|-------------|------------|
| Feedback Voltage | | | | | | | |
| Feedback Voltage | V_{FB} | | 0.594 | 0.6 | 0.606 | V | |
| Feedback Current | I_{FB} | $V_{FB} = 4V$ | -50 | | 50 | nA | |
| Internal MOSFET | | | | | | | |
| Switch-On Resistance | High-Side | $R_{DS(ON)_H}$ | $V_{BOOT} - V_{LX} = 4.8V$ | -- | 30 | -- | m Ω |
| | Low-Side | $R_{DS(ON)_L}$ | | -- | 20 | -- | m Ω |
| Discharge FET R_{ON} | R_{DISCHG} | | -- | 50 | -- | Ω | |
| Current Limit | | | | | | | |
| High-Side Switch Current Limit | I_{LIM_H} | | -- | 11 | -- | A | |
| Low-Side Switch Valley Current Limit | I_{LIM_L} | | 6.3 | 8.5 | 10.7 | A | |
| Switching Frequency | | | | | | | |
| Switching Frequency | f_{SW} | | 400 | 500 | 600 | kHz | |
| On-Time Timer Control | | | | | | | |
| Minimum On-Time | $t_{ON(MIN)}$ | $V_{IN} = V_{IN(MAX)}$ | -- | 60 | -- | ns | |
| Minimum Off-Time | $t_{OFF(MIN)}$ | | -- | 200 | -- | ns | |
| Thermal Shutdown | | | | | | | |
| Thermal Shutdown Threshold | T_{SD} | | -- | 150 | -- | $^{\circ}C$ | |
| Thermal Shutdown Hysteresis | ΔT_{SD} | | -- | 15 | -- | $^{\circ}C$ | |
| Output Under Voltage | | | | | | | |
| UVP Trip Threshold | | UVP detect | -- | 60 | -- | % | |
| | | Hysteresis | -- | 10 | -- | % | |

Note 1. Stresses beyond those listed “Absolute Maximum Ratings” may cause permanent damage to the device. These are stress ratings only, and functional operation of the device at these or any other conditions beyond those indicated in the operational sections of the specifications is not implied. Exposure to absolute maximum rating conditions may affect device reliability.

Note 2. θ_{JA} is measured under natural convection (still air) at $T_A = 25^{\circ}C$ with the component mounted on a high effective-thermal-conductivity four-layer test board on a JEDEC 51-7 thermal measurement standard. The first layer is filled with copper. θ_{JC} is measured at the lead of the package.

Note 3. Devices are ESD sensitive. Handling precaution is recommended.

Note 4. The device is not guaranteed to function outside its operating conditions.

Typical Operating Characteristics

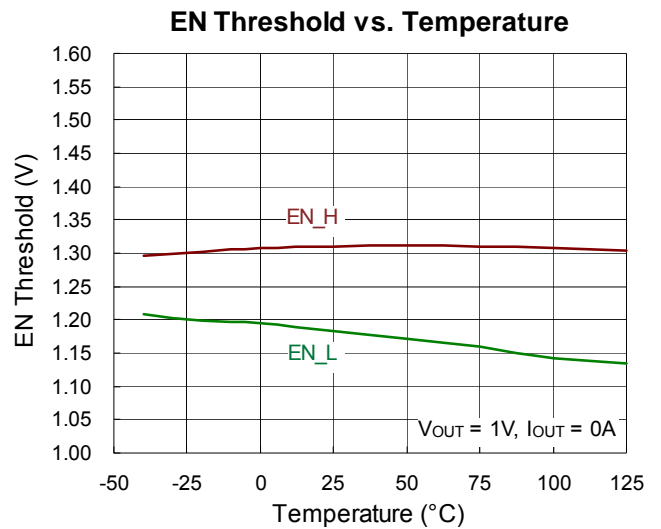
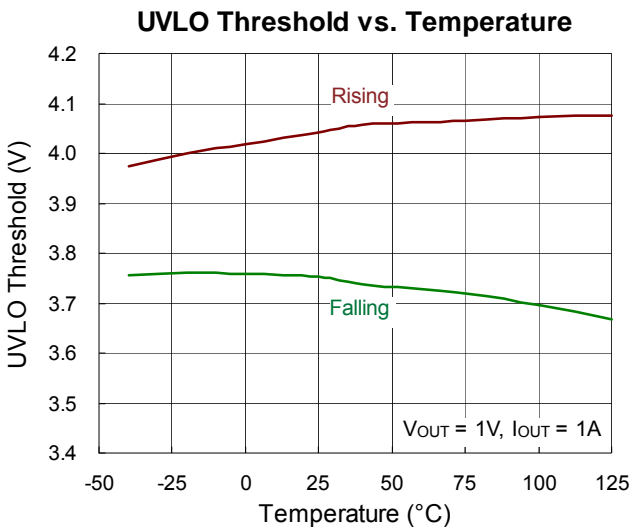
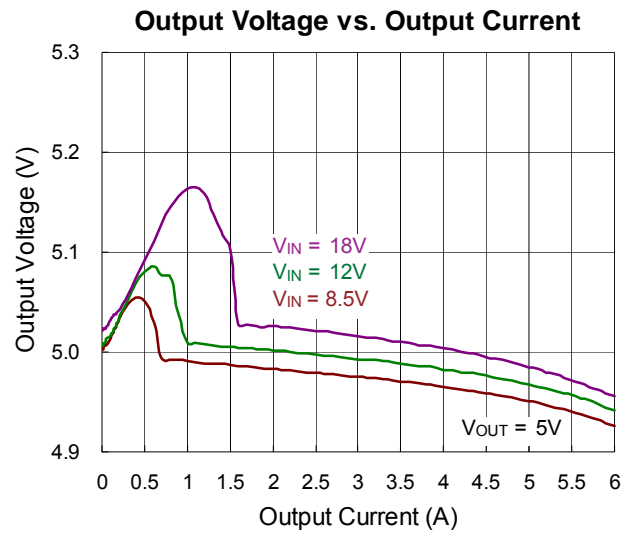
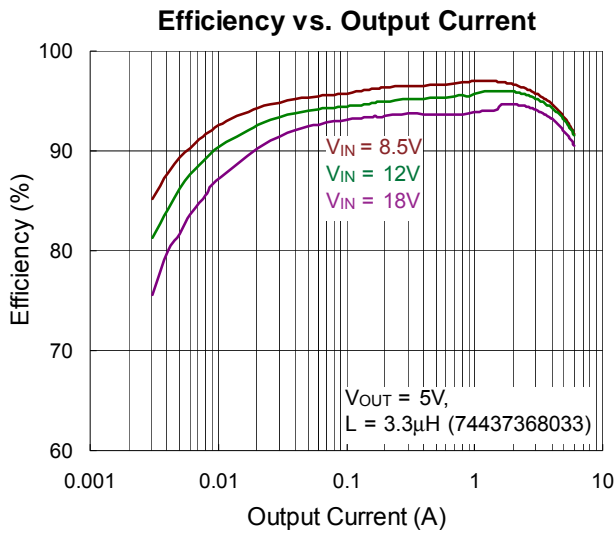
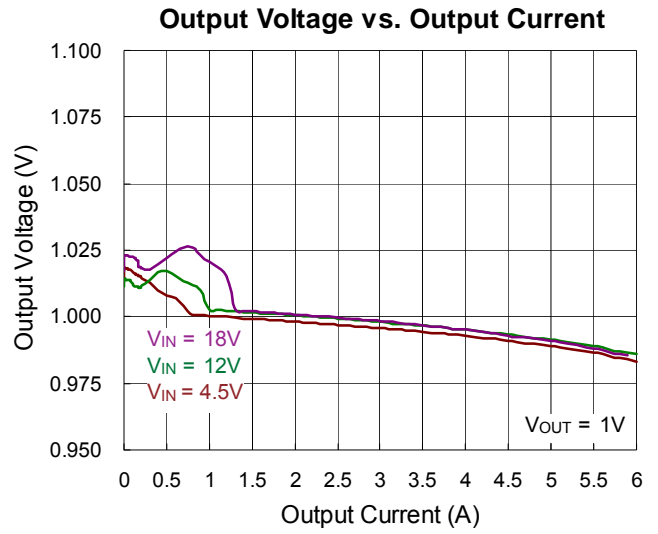
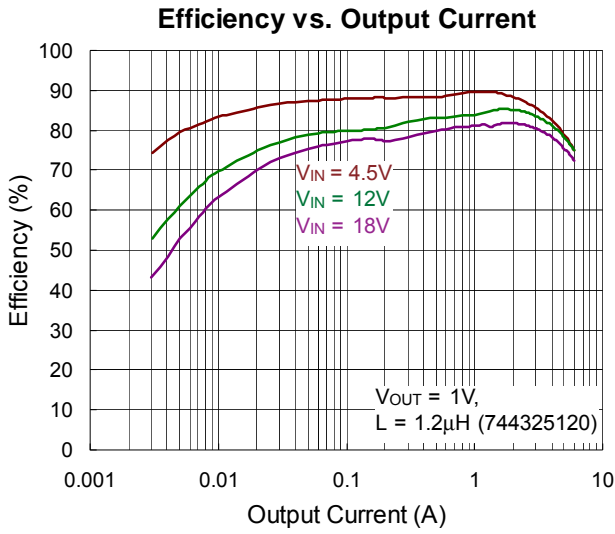

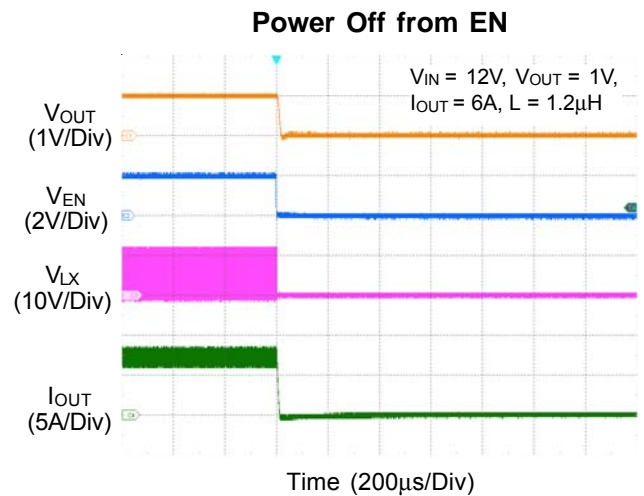
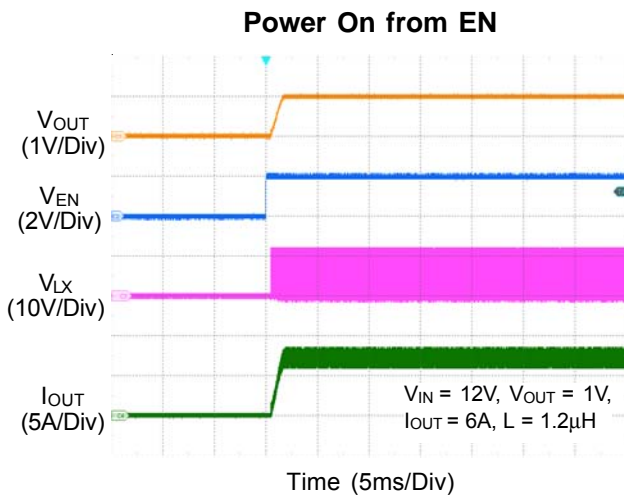
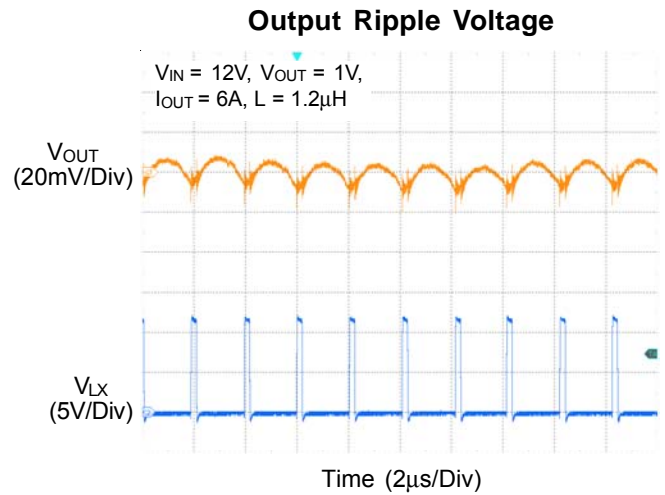
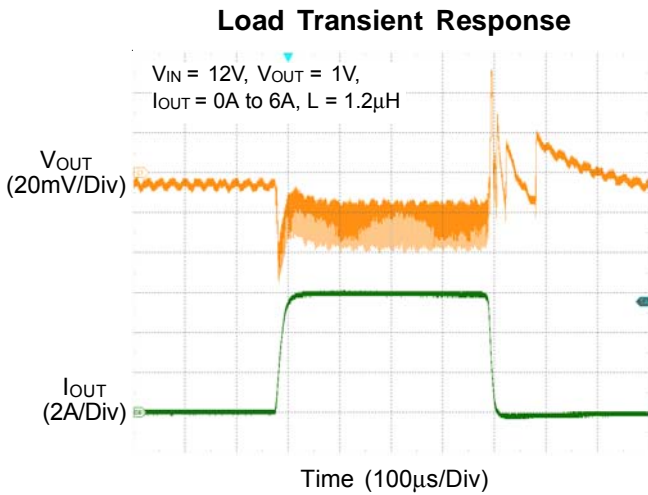
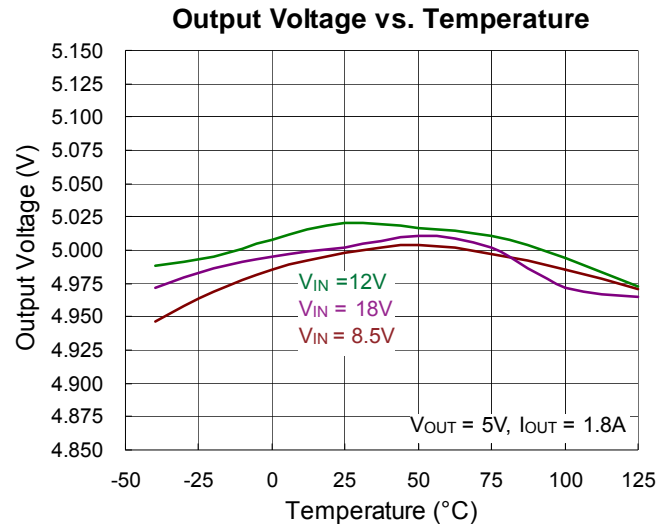
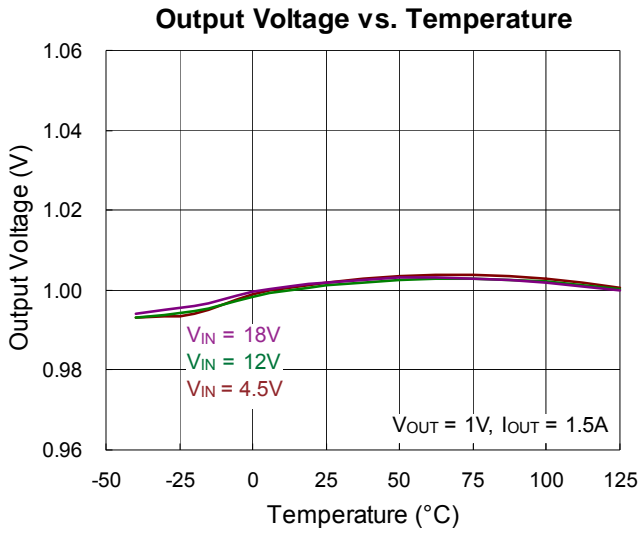

Power On from VIN

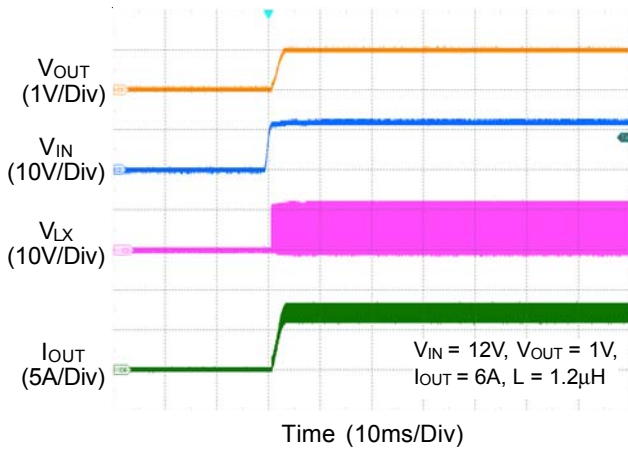

Power Off from VIN

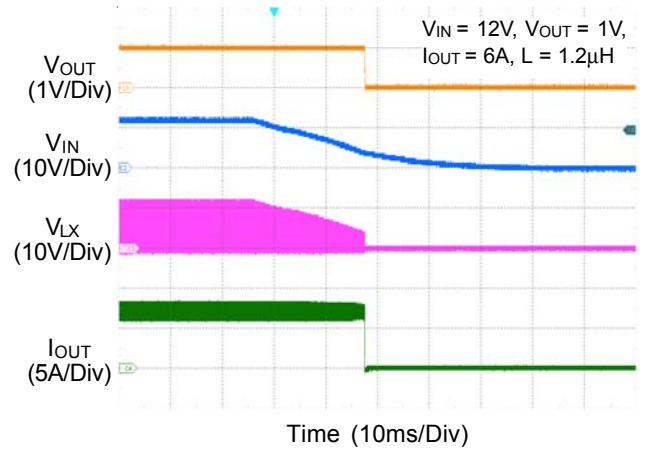

Application Information

Inductor Selection

The consideration of inductor selection includes inductance, RMS current rating and, saturation current rating. The inductance selection is generally flexible and is optimized for the low cost, low physical size, and high system performance.

Choosing lower inductance to reduce physical size and cost, and it is useful to improve the transient response. However, it causes the higher inductor peak current and output ripple voltage to decrease system efficiency. Conversely, higher inductance increase system efficiency, but the physical size of inductor will become larger and transient response will be slow because more transient time is required to change current (up or down) by inductor. A good compromise between size, efficiency, and transient response is to set a inductor ripple current (ΔI_L) about 20% to 50% of the desired full output load current.

Calculate the approximate inductance by the input voltage, output voltage, switching frequency (f_{SW}), maximum rated output current ($I_{OUT(MAX)}$) and inductor ripple current (ΔI_L).

$$L = \frac{V_{OUT} \times (V_{IN} - V_{OUT})}{V_{IN} \times f_{SW} \times \Delta I_L}$$

Once the inductance is chosen, the inductor ripple current (ΔI_L) and peak inductor current can be calculated.

$$\Delta I_L = \frac{V_{OUT} \times (V_{IN} - V_{OUT})}{V_{IN} \times f_{SW} \times L}$$

$$I_{L(PEAK)} = I_{OUT(MAX)} + \frac{1}{2} \Delta I_L$$

$$I_{L(VALLY)} = I_{OUT(MAX)} - \frac{1}{2} \Delta I_L$$

The typical operating circuit design for the RT6257A/B, the output voltage is 5V, maximum rated output current is 6A, input voltage is 12V, and inductor ripple current is 1.8A which is 30% of the maximum rated output current, the calculated inductance value is :

$$L = \frac{5 \times (12 - 5)}{12 \times 500 \times 10^3 \times 1.8} = 3.24 \mu H$$

The inductor ripple current set at 1.8A and so we select 3.3 μ H inductance. The actual inductor ripple current and required peak current is shown as below :

$$\Delta I_L = \frac{5 \times (12 - 5)}{12 \times 500 \times 10^3 \times 3.3 \times 10^{-6}} = 1.77 A$$

$$I_{L(PEAK)} = I_{OUT(MAX)} + \frac{1}{2} \Delta I_L = 6 + \frac{1.77}{2} = 6.885 A$$

Inductor saturation current should be chosen over IC's valley current limit.

Input Capacitor Selection

The effective input capacitance is a function of the input voltage (V_{IN}), output voltage (V_{OUT}), rated output current (I_{OUT}), switching frequency (f_{SW}), and input ripple voltage of the regulator (ΔV_{INP}) :

$$C_{IN(MIN)} = \frac{I_{OUT} \times \frac{V_{OUT}}{V_{IN}} \times \left(1 - \frac{V_{OUT}}{V_{IN}}\right)}{f_{SW} \times \Delta V_{INP}}$$

Ceramic capacitors are most often used because of their low cost, small size, high RMS current ratings, and robust surge current capabilities. It should pay attention that value of capacitors change as temperature, bias voltage, and operating frequency change. For example the capacitance value of a capacitor decreases as the dc bias across the capacitor increases. Several ceramic capacitors may be paralleled to meet the RMS current, size, and height requirements of the application. Considering the DC bias effects for the input capacitor, the typical operating circuit used two 10 μ F low ESR ceramic capacitors on the VIN pin and an additional 0.1 μ F is recommended to place as close as possible to the IC input side for high frequency filtering.

Output Capacitor Selection

The RT6257A/B is optimized for output terminal with ceramic capacitors application and best performance will be obtained using them. The total output capacitance value is usually determined by the desired output ripple voltage level and transient response requirements for sag which is undershoot on positive load steps and soar which is overshoot on negative load steps.

Output Ripple Voltage

Output ripple voltage at the switching frequency is caused by the inductor current ripple and its effect on the output capacitor's ESR and stored charge. These two ripple components are called ESR ripple and capacitive ripple.

Since ceramic capacitors have extremely low ESR and relatively little capacitance, both components are similar in amplitude and both should be considered if ripple is critical.

$$V_{\text{RIPPLE}} = V_{\text{RIPPLE(ESR)}} + V_{\text{RIPPLE(C)}}$$

$$V_{\text{RIPPLE(ESR)}} = \Delta I_L \times R_{\text{ESR}}$$

$$V_{\text{RIPPLE(C)}} = \frac{\Delta I_L}{8 \times C_{\text{OUT}} \times f_{\text{SW}}}$$

The typical operating circuit design for the RT6257A/B, the output voltage is 5V, inductor ripple current is 1.77A, and using 2 pieces of 22μF output capacitor with about 5mΩ ESR, the output voltage ripple components are :

$$V_{\text{RIPPLE(ESR)}} = \Delta I_L \times R_{\text{ESR}} = 1.77\text{A} \times 5\text{m}\Omega = 8.85\text{mV}$$

$$V_{\text{RIPPLE(C)}} = \frac{\Delta I_L}{8 \times C_{\text{OUT}} \times f_{\text{SW}}} = \frac{1.77\text{A}}{8 \times 44\mu\text{F} \times 500\text{kHz}} = 10\text{mV}$$

$$V_{\text{RIPPLE}} = V_{\text{RIPPLE(ESR)}} + V_{\text{RIPPLE(C)}} = 18.85\text{mV}$$

Output Transient Undershoot and Overshoot

In addition to output ripple voltage at the switching frequency, the output capacitor and its ESR also affect the voltage sag (undershoot) and soar (overshoot) when the load steps up and down abruptly. The ACOT transient response is very quick and output transients are usually small. However, the combination of small ceramic output capacitors (with little capacitance), low output voltages (with little stored charge in the output capacitors), and low duty cycle applications (which require high inductance to get reasonable ripple currents with high input voltages) increases the size of voltage variations in response to very quick load changes. Typically, load changes occur slowly with respect to the IC's 500kHz switching frequency. But some modern digital loads can exhibit nearly instantaneous load changes and the following section shows how to calculate the worst-case voltage swings in response to very fast load steps.

The output voltage transient undershoot and overshoot each have two components : the voltage steps caused by the

output capacitor's ESR, and the voltage sag and soar due to the finite output capacitance and the inductor current slew rate. Use the following formulas to check if the ESR is low enough (typically not a problem with ceramic capacitors) and the output capacitance is large enough to prevent excessive sag and soar on very fast load step edges, with the chosen inductor value.

The amplitude of the ESR step up or down is a function of the load step and the ESR of the output capacitor :

$$V_{\text{ESR_STEP}} = \Delta I_{\text{OUT}} \times R_{\text{ESR}}$$

The amplitude of the capacitive sag is a function of the load step, the output capacitor value, the inductor value, the input-to-output voltage differential, and the maximum duty cycle. The maximum duty cycle during a fast transient is a function of the on-time and the minimum off-time since the ACOT™ control scheme will ramp the current using on-times spaced apart with minimum off-times, which is as fast as allowed. Calculate the approximate on-time (neglecting parasitics) and maximum duty cycle for a given input and output voltage as :

$$t_{\text{ON}} = \frac{V_{\text{OUT}}}{V_{\text{IN}} \times f_{\text{SW}}} \text{ and } D_{\text{MAX}} = \frac{t_{\text{ON}}}{t_{\text{ON}} + t_{\text{OFF(MIN)}}}$$

The actual on-time will be slightly longer as the IC compensates for voltage drops in the circuit, but we can neglect both of these since the on-time increase compensates for the voltage losses. Calculate the output voltage sag as :

$$V_{\text{SAG}} = \frac{L \times (\Delta I_{\text{OUT}})^2}{2 \times C_{\text{OUT}} \times (V_{\text{IN(MIN)}} \times D_{\text{MAX}} - V_{\text{OUT}})}$$

The amplitude of the capacitive soar is a function of the load step, the output capacitor value, the inductor value and the output voltage :

$$V_{\text{SOAR}} = \frac{L \times (\Delta I_{\text{OUT}})^2}{2 \times C_{\text{OUT}} \times V_{\text{OUT}}}$$

Feed-Forward Capacitor (C_{FF})

The RT6257A/B is optimized for ceramic output capacitors and for low duty cycle applications. However for high-output voltages, with high feedback attenuation, the circuit's transient response can be slowed. In high-output voltage circuits transient response is improved by adding a small “feedforward” capacitor (C_{FF}) across the upper FB divider resistor (Figure 1), to speed up the transient response without affecting the steady-state stability of the circuit. Choose a suitable capacitor value that following suggested component BOM.

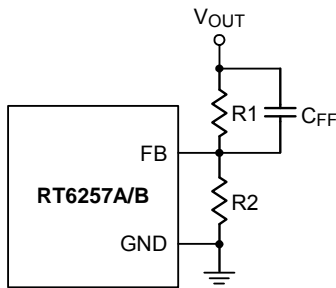

Figure 1. C_{FF} Capacitor Setting

Enable Operation (EN)

For automatic start-up the high-voltage EN pin can be connected to V_{IN}, through a 100kΩ resistor. Its large hysteresis band makes EN useful for simple delay and timing circuits. EN can be externally pulled to V_{IN} by adding a resistor-capacitor delay (R_{EN} and C_{EN} in Figure 2). Calculate the delay time using EN's internal threshold where switching operation begins.

An external MOSFET can be added to implement digital control of EN when no system voltage above 2V is available (Figure 3). In this case, a 100kΩ pull-up resistor, R_{EN}, is connected between V_{IN} and the EN pin. MOSFET Q1 will be under logic control to pull down the EN pin. To prevent enabling circuit when V_{IN} is smaller than the V_{OUT} target value or some other desired voltage level, a resistive voltage divider can be placed between the input voltage and ground and connected to EN to create an additional input under voltage lockout threshold (Figure 4).

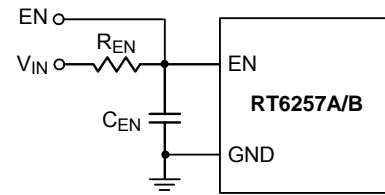

Figure 2. External Timing Control

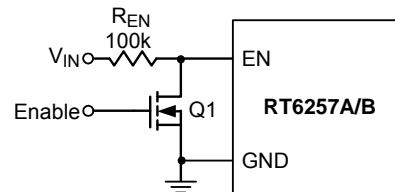

Figure 3. Digital Enable Control Circuit

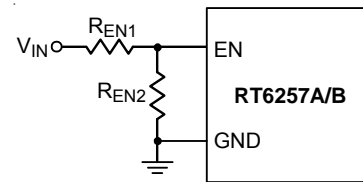

Figure 4. Resistor Divider for Lockout Threshold Setting

Output Voltage Setting

Set the desired output voltage using a resistive divider from the output to ground with the midpoint connected to FB. The output voltage is set according to the following equation :

$$V_{OUT} = 0.6V \times \left(1 + \frac{R1}{R2}\right)$$

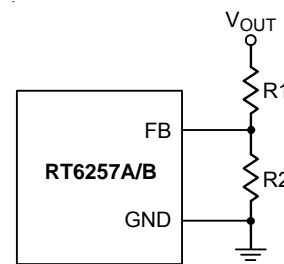

Figure 5. Output Voltage Setting

Place the FB resistors within 5mm of the FB pin. Choose R2 between 10kΩ and 100kΩ to minimize power consumption without excessive noise pick-up and calculate R1 as follows :

$$R1 = \frac{R2 \times (V_{OUT} - V_{REF})}{V_{REF}}$$

For output voltage accuracy, use divider resistors with 1% or better tolerance.

External BOOT Bootstrap Diode

When the input voltage is lower than 5.5V it is recommended to add an external bootstrap diode between VIN and the BOOT pin to improve enhancement of the internal MOSFET switch and improve efficiency. The bootstrap diode can be a low cost one such as 1N4148 or BAT54.

External BOOT Capacitor Series Resistance

The internal power MOSFET switch gate driver is optimized to turn the switch on fast enough for low power loss and good efficiency, but also slow enough to reduce EMI. Switch turn-on is when most EMI occurs since V_{LX} rises rapidly. During switch turn-off, LX is discharged relatively slowly by the inductor current during the dead time between high-side and low-side switch on-times. In some cases it is desirable to reduce EMI further, at the expense of some additional power dissipation. The switch turn-on can be slowed by placing a small ($<47\Omega$) resistance between BOOT and the external bootstrap capacitor. This will slow the high-side switch turn-on and V_{LX} 's rise. To remove the resistor from the capacitor charging path (avoiding poor enhancement due to undercharging the BOOT capacitor), use the external diode shown in Figure 6 to charge the BOOT capacitor and place the resistance between BOOT and the capacitor/diode connection.

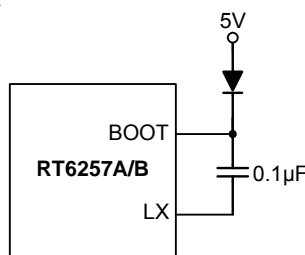

Figure 6. External Bootstrap Diode

Thermal Considerations

The junction temperature should never exceed the absolute maximum junction temperature $T_{J(MAX)}$, listed under Absolute Maximum Ratings, to avoid permanent damage to the device. The maximum allowable power dissipation depends on the thermal resistance of the IC package, the PCB layout, the rate of surrounding airflow, and the difference between the junction and ambient temperatures. The maximum power dissipation can be calculated using the following formula :

$$P_{D(MAX)} = (T_{J(MAX)} - T_A) / \theta_{JA}$$

where $T_{J(MAX)}$ is the maximum junction temperature, T_A is the ambient temperature, and θ_{JA} is the junction-to-ambient thermal resistance.

For continuous operation, the maximum operating junction temperature indicated under Recommended Operating Conditions is 125°C. The junction-to-ambient thermal resistance, θ_{JA} , is highly package dependent. For a TSOT-23-6 (FC) package, the thermal resistance, θ_{JA} , is 47°C/W on a standard JEDEC 51-7 high effective-thermal-conductivity four-layer test board. The maximum power dissipation at $T_A = 25^\circ\text{C}$ can be calculated as below :

$$P_{D(MAX)} = (125^\circ\text{C} - 25^\circ\text{C}) / (47^\circ\text{C/W}) = 2.12\text{W for a TSOT-23-6 (FC) package.}$$

The maximum power dissipation depends on the operating ambient temperature for the fixed $T_{J(MAX)}$ and the thermal resistance, θ_{JA} . The derating curves in Figure 7 allows the designer to see the effect of rising ambient temperature on the maximum power dissipation.

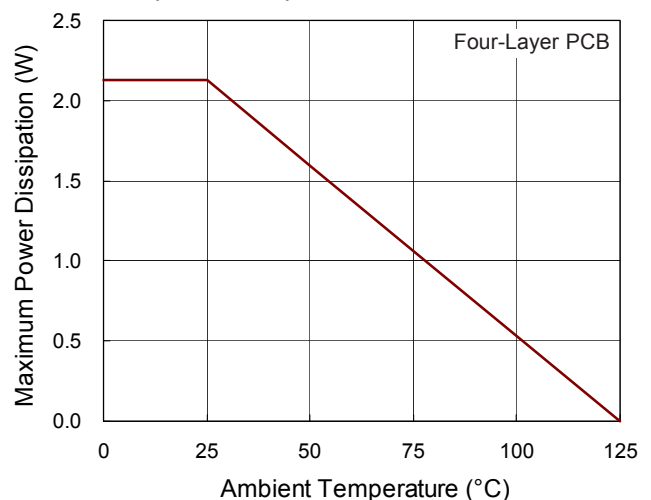

Figure 7. Derating Curve of Maximum Power Dissipation

Layout Considerations

Follow the PCB layout guidelines for optimal performance of the device.

- ▶ Keep the traces of the main current paths as short and wide as possible.
- ▶ Put the input capacitor as close as possible to VIN pin.
- ▶ LX node is with high frequency voltage swing and should be kept at small area. Keep analog components away from the LX node to prevent stray capacitive noise pickup.
- ▶ Connect feedback network behind the output capacitors. Keep the loop area small. Place the feedback components near the device.
- ▶ Connect all analog grounds to a common node and then connect the common node to the power ground behind the output capacitors.
- ▶ An example of the RT6257A/B PCB layout guide is shown in Figure 8 for references.

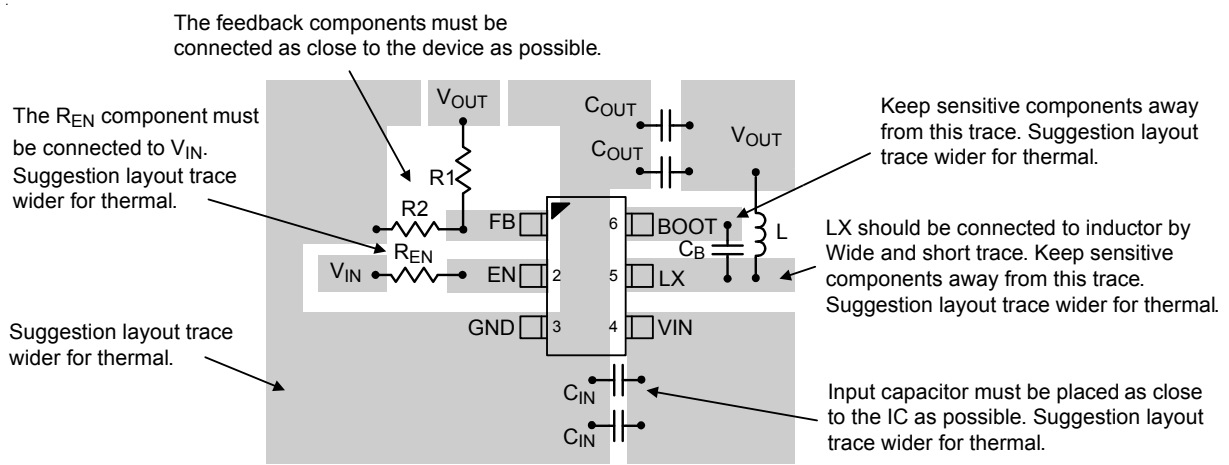
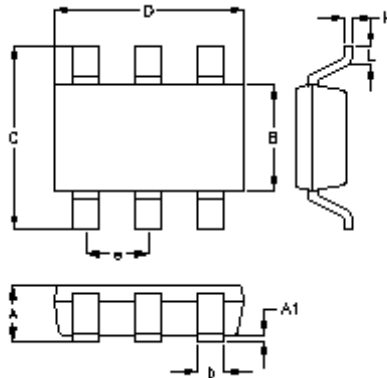

Figure 8. PCB Layout Guide

Outline Dimension



| Symbol | Dimensions In Millimeters | | Dimensions In Inches | |
|--------|---------------------------|-------|----------------------|-------|
| | Min. | Max. | Min. | Max. |
| A | 0.700 | 1.000 | 0.028 | 0.039 |
| A1 | 0.000 | 0.100 | 0.000 | 0.004 |
| B | 1.397 | 1.803 | 0.055 | 0.071 |
| b | 0.300 | 0.559 | 0.012 | 0.022 |
| C | 2.591 | 3.000 | 0.102 | 0.118 |
| D | 2.692 | 3.099 | 0.106 | 0.122 |
| e | 0.950 | | 0.037 | |
| H | 0.080 | 0.254 | 0.003 | 0.010 |
| L | 0.300 | 0.610 | 0.012 | 0.024 |

TSOT-23-6 (FC) Surface Mount Package

Richtek Technology Corporation

14F, No. 8, Tai Yuen 1st Street, Chupei City
 Hsinchu, Taiwan, R.O.C.
 Tel: (8863)5526789

Richtek products are sold by description only. Richtek reserves the right to change the circuitry and/or specifications without notice at any time. Customers should obtain the latest relevant information and data sheets before placing orders and should verify that such information is current and complete. Richtek cannot assume responsibility for use of any circuitry other than circuitry entirely embodied in a Richtek product. Information furnished by Richtek is believed to be accurate and reliable. However, no responsibility is assumed by Richtek or its subsidiaries for its use; nor for any infringements of patents or other rights of third parties which may result from its use. No license is granted by implication or otherwise under any patent or patent rights of Richtek or its subsidiaries.