

## LARISA-WW-CLIP8

~55° wide beam. Clip fastening for 0.8 mm thick PCB

### TECHNICAL SPECIFICATIONS:

Dimensions	10x10 mm
Height	7.5 mm
Fastening	glue, clips
Colour	black
Box size	
Box weight	7 kg
Quantity in Box	10000 pcs
ROHS compliant	yes ⓘ



### MATERIAL SPECIFICATIONS:

Component	Type	Material	Colour
LARISA-WW	Lens	PMMA	clear
LARISA-HOLDER-CLIP8	Holder	PC	black

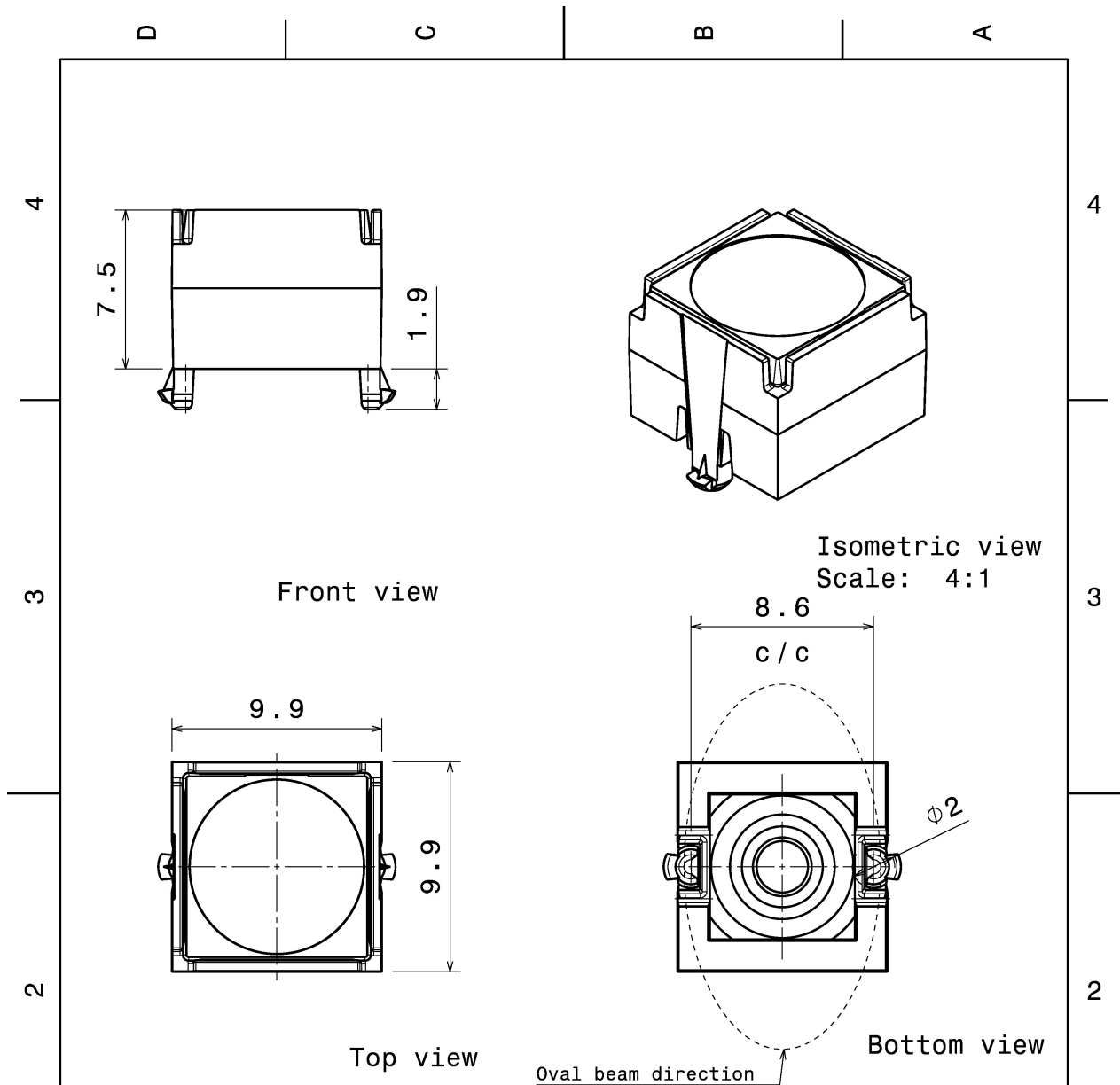

Isometric view  
Scale: 4:1

INDEX	PART NO	DESCRIPTION	MATERIAL	COLOUR
1	-	LARISA lens	PMMA	
2	C12907	LARISA-HOLDER-CLIP8	PC	black

Tolerances if not otherwise shown  
According to DIN ISO 2768-1  
Linear measures:  
Up to 30mm class M, otherwise class C.  
According to DIN ISO 2768-2  
Form and position: class L



Ledil Oy  
Salorankatu 10  
FIN 24240 SALO  
Finland

THIRD ANGLE PROJECTION:

DRAWING TITLE  
**LARISA-CLIP8**

This drawing is the property of LEDiL Oy. It may not be reproduced, copied or communicated without a written agreement with LEDiL Oy.

SIZE	PART NUMBER
A4	-

SCALE	4:1	WEIGHT	0,6 g	SHEET	1/1
-------	-----	--------	-------	-------	-----

#### PHOTOMETRIC DATA (MEASURED):



LED XB-D  
FWHM 57.0°  
Efficiency 84 %  
Peak intensity 0.900 cd/lm  
Required components:

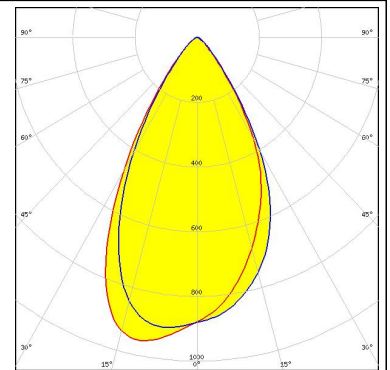
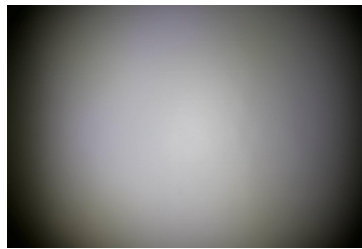

LED LUXEON A  
FWHM 70.0°  
Efficiency 85 %  
Peak intensity 0.700 cd/lm  
Required components:

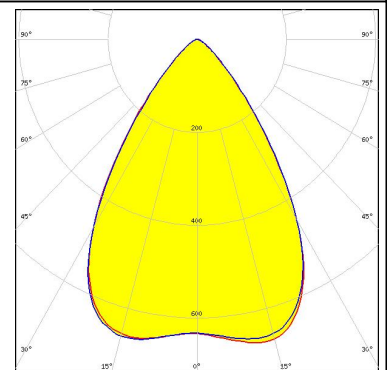
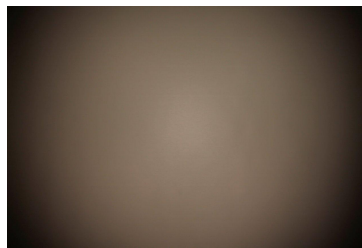

LED LUXEON Rebel  
FWHM 62.0°  
Efficiency 88 %  
Peak intensity 0.900 cd/lm  
Required components:

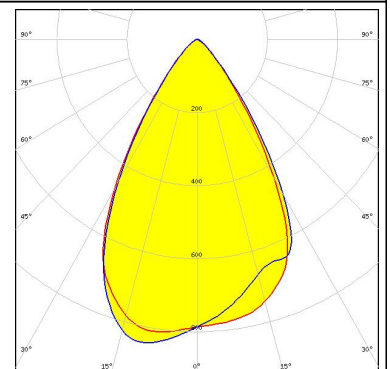
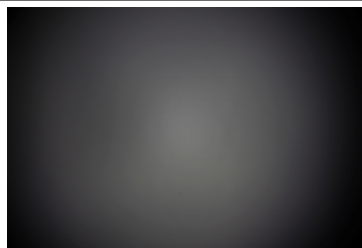

LED LUXEON Rebel ES  
FWHM 60.0°  
Efficiency 86 %  
Peak intensity 0.900 cd/lm  
Required components:

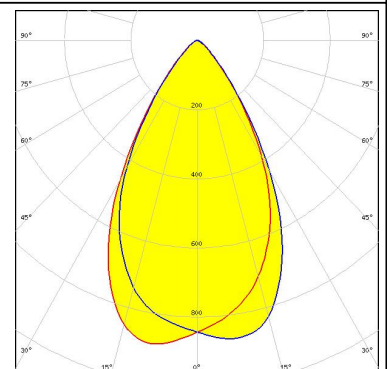
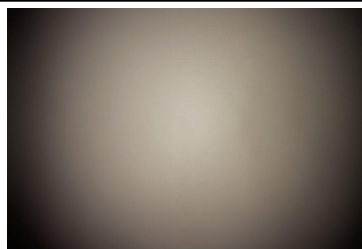

#### PHOTOMETRIC DATA (MEASURED):



LED NCSxx19A  
FWHM 52.0°  
Efficiency 83 %  
Peak intensity 1.000 cd/lm  
Required components:

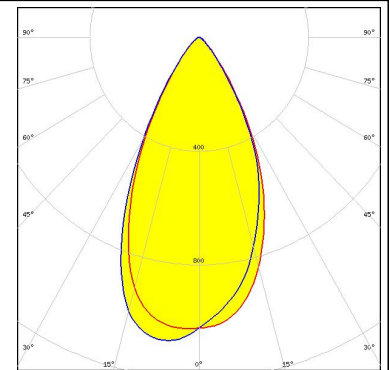
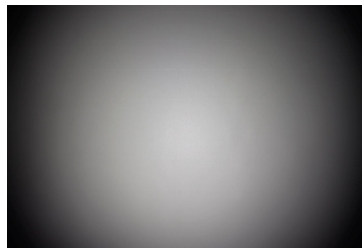

LED NF2x757A  
FWHM 49.0°  
Efficiency 87 %  
Peak intensity 1.230 cd/lm  
Required components:

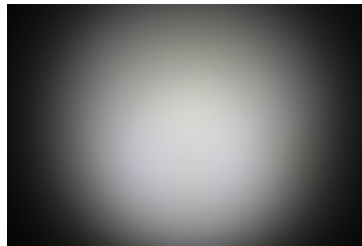

LED NF2x757G  
FWHM 47.0°  
Efficiency 85 %  
Peak intensity 1.140 cd/lm  
Required components:

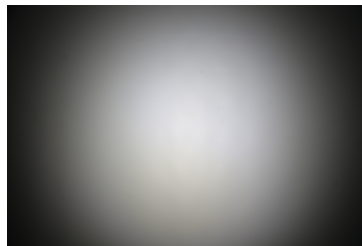

LED NVSxx19A  
FWHM 57.0°  
Efficiency 90 %  
Peak intensity 0.900 cd/lm  
Required components:

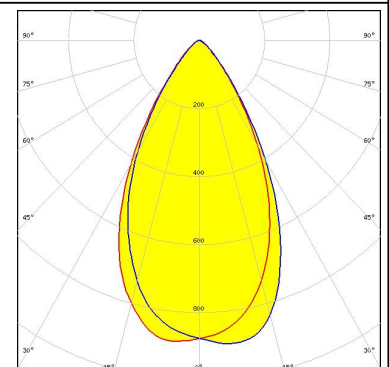
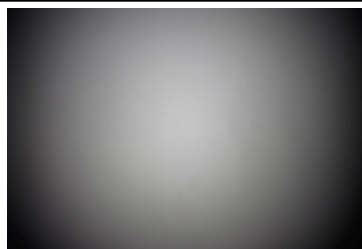

#### PHOTOMETRIC DATA (MEASURED):

**OSRAM**  
Opto Semiconductors

LED Duris S5 (2 chip)

FWHM 50.0°

Efficiency 86 %

Peak intensity 1.200 cd/lm

Required components:

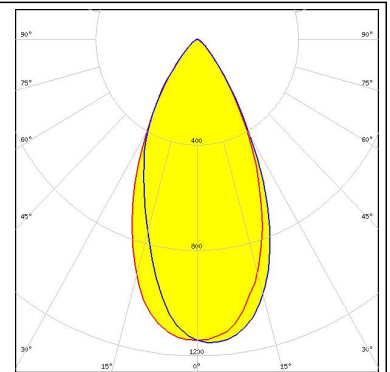

**OSRAM**  
Opto Semiconductors

LED Oslon SSL 80

FWHM 66.0°

Efficiency 84 %

Peak intensity 0.900 cd/lm

Required components:

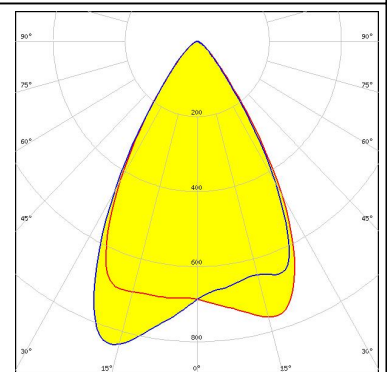
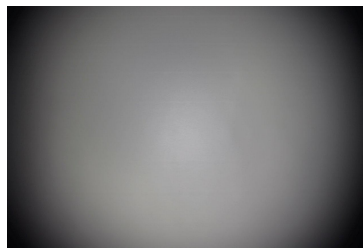

#### GENERAL INFORMATION:

NOTE: The typical beam angle will be changed by different color, chip size and chip position tolerance. The typical total beam angle is the full angle measured where the luminous intensity is half of the peak value.

#### MATERIALS:

As part of our continuous research and improvement processes, and to ensure the best possible quality and availability of our products, LEDiL reserves the right to change material grades without notice.

#### PRODUCT DATA USER AGREEMENT AND DISCLAIMER:

The measured data in the provided downloadable LEDiL Product Datasheets and Mechanical 2D-Drawings is rounded and provided as reference for planning. LEDiL Oy's optical specifications have been verified by conducting performance testing of the products in accordance with the company's quality system. The reported data are averaged results of multiple measurements with typical variation. LEDiL Oy reserves the right to without prior notification make changes and improvements to its products.

LEDiL Oy assumes neither warranty, nor guarantee nor any other liability of any kind for the contents and correctness of the provided data. The provided data has been generated with highest diligence but the provided data may in reality not represent the complete possible variation range of all intrinsic parameters. Therefore, in certain cases a deviation from the provided data could occur.

LEDiL Oy reserves the right to undertake technical changes of its products without further notification which could lead to changes in the provided data. LEDiL Oy assumes no liability of any kind for the possible deviation from any provided data or any other damage resulting from the usage of the provided data.

The user agrees to this disclaimer and user agreement with the download or usage of the provided files.

#### LEDiL Oy

Joensuunkatu 13  
FI-24240 SALO  
Finland

#### LEDiL Inc.

228 West Page Street  
Suite D  
Sycamore IL 60178  
USA

#### Local sales and technical support

[www.ledil.com/  
where\\_to\\_buy](http://www.ledil.com/where_to_buy)

#### Shipping locations

Salo, Finland  
Hong Kong, China

#### Distribution Partners

[www.ledil.com/  
where\\_to\\_buy](http://www.ledil.com/where_to_buy)