

# Dual Output Fixed Output LDO Regulators

## BA3258HFP BA33Dxx series

### ●General Description

The BA3258HFP, BA33D15HFP, BA33D18HFP are fixed 2-output low-saturation regulators with a voltage accuracy at both outputs of  $\pm 2\%$ . These series incorporate both overcurrent protection and thermal shutdown (TSD) circuits in order to prevent damage due to output short-circuiting and overloading, respectively.

### ●Features

- Output voltage accuracy:  $\pm 2\%$ .
- A ceramic capacitor can be used to prevent output oscillation (BA3258HFP).
- High Ripple Rejection (BA33Dxx Series)
- Built-in thermal shutdown circuit
- Built-in overcurrent protection circuit

### ●Package

W (Typ.) x D (Typ.) x H (Max.)  
HRP5 9.395mm x 10.54 mm x 2.005mm



### ●Key Specifications

- Input Power Supply Voltage:
 

BA3258HFP	14.0V(Max.)
BA33Dxx Series	16.0V(Max.)
- Output voltage range: Fixed
- Output current:
 

BA3258HFP	1A (Max.)
BA33Dxx Series	0.5A(Max.)
- Operating temperature range:
 

BA3258HFP	-30°C to 85°C
BA33Dxx Series	-25°C to 105°C

### ●Applications

FPDs, TVs, PCs, DSPs in DVDs and CDs

### ●Ordering Information

<b>B A 3 x x x H F P</b>	<b>-</b>	<b>T R</b>
Part Number	Package HFP:HRP5	Packaging and forming specification TR: Embossed tape and reel (HRP5)

### ●Lineup

Maximum output current (Max.)	Output Voltage 1 (Typ.)	Output Voltage 2 (Typ.)	Package		Orderable Part Number
1A	3.3V	1.5V	HRP5	Reel of 2000	BA3258HFP-TR
0.5A	3.3V	1.5V			BA33D15HFP-TR
	3.3V	1.8V			BA33D18HFP-TR

●Block Diagrams / Standard Example Application Circuits / Pin Configurations / Pin Descriptions

BA3258HFP

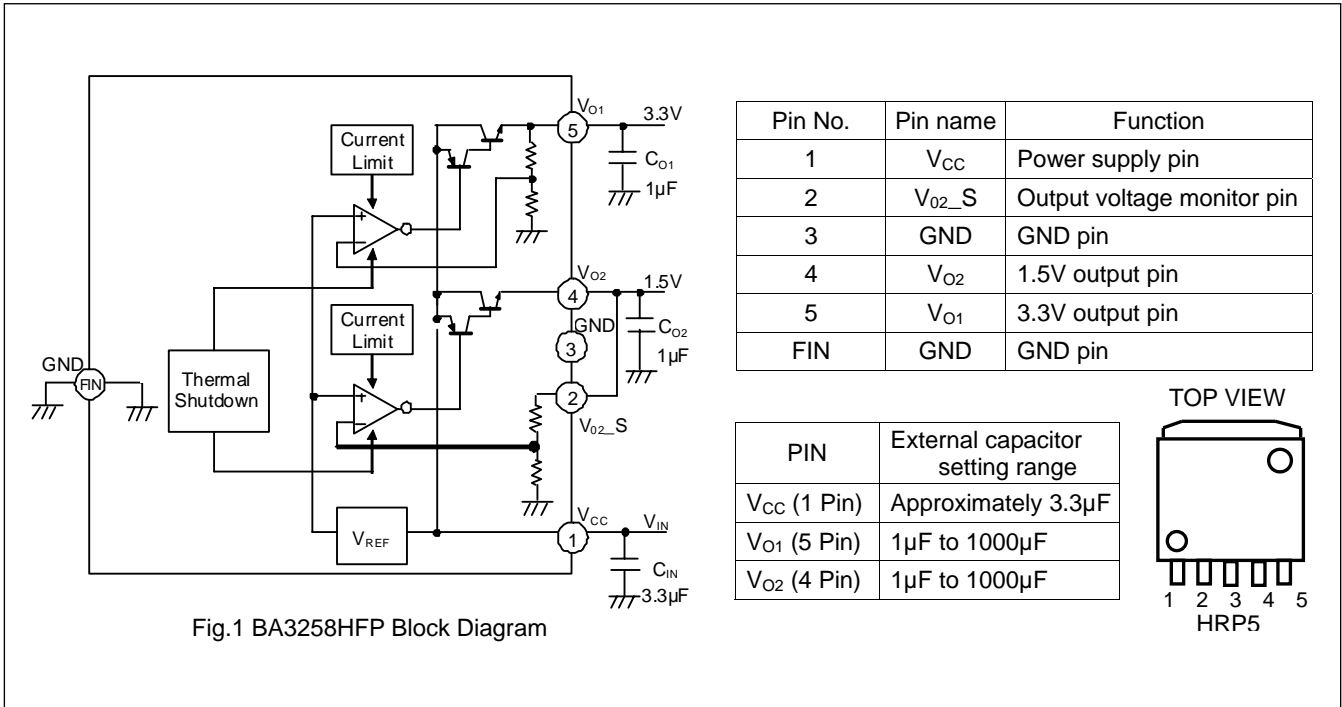

Fig.1 BA3258HFP Block Diagram

BA33DxxSeries

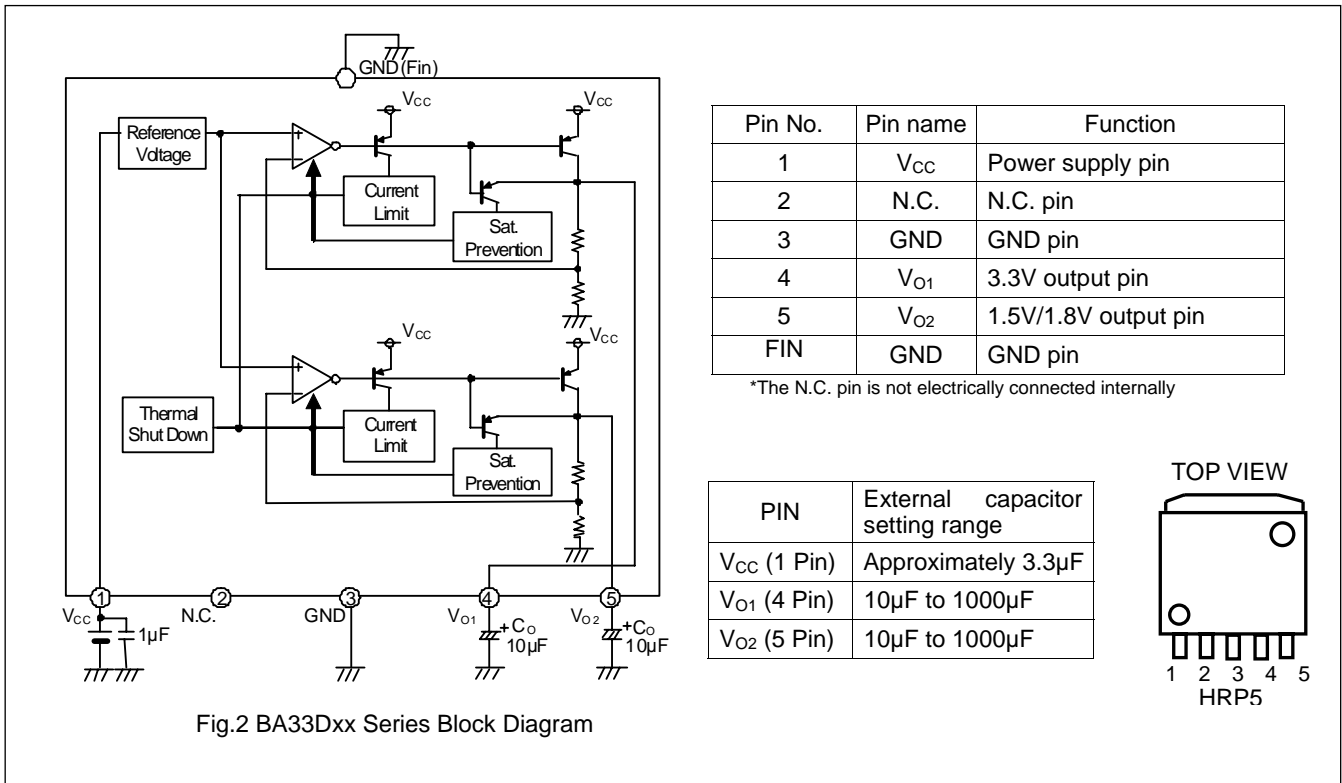

Fig.2 BA33Dxx Series Block Diagram

●Absolute Maximum Ratings

BA3258HFP

Parameter	Symbol	Ratings	Unit
Applied voltage	V <sub>CC</sub>	15 <sup>*1</sup>	V
Power dissipation	Pd <sup>*2</sup>	2300 <sup>*2</sup>	mW
Operating temperature range	Topr	-30 to 85	°C
Ambient storage temperature	Tstg	-55 to 150	°C
Maximum junction temperature	Tjmax	150	°C

\*1 Must not exceed Pd

\*2. Derated at 18.4 mW/°C at Ta>25°C when mounted on a glass epoxy board (70 mm × 70 mm × 1.6 mm)

BA33Dxx Series

Parameter	Symbol	Ratings	Unit
Applied voltage	V <sub>CC</sub>	18 <sup>*1</sup>	V
Power dissipation	Pd <sup>*2</sup>	2300 <sup>*2</sup>	mW
Operating temperature range	Topr	-25 to 105	°C
Ambient storage temperature	Tstg	-55 to 150	°C
Maximum junction temperature	Tjmax	150	°C

●Recommended Operating Ratings

BA3258HFP

Parameter	Symbol	Ratings			Unit
		Min.	Typ.	Max.	
Input power supply voltage	V <sub>CC</sub>	4.75	-	14.0	V
3.3 V output current	I <sub>O1</sub>	-	-	1	A
1.5 V output current	I <sub>O2</sub>	-	-	1	A

BA33DxxSeries

Parameter	Symbol	Ratings			Unit
		Min.	Typ.	Max.	
Input power supply voltage	V <sub>CC</sub>	4.1	-	16.0	V
3.3 V output current	I <sub>O1</sub>	-	-	0.5	A
1.5V output current	I <sub>O2</sub>	-	-	0.5	A
1.8 V output current	I <sub>O2</sub>	-	-	0.5	A

●Electrical Characteristics

BA3258HFP (Unless otherwise specified, Ta = 25°C, V<sub>CC</sub> = 5 V)

Parameter	Symbol	Limits			Unit	Conditions
		Min.	Typ.	Max.		
Bias current	I <sub>B</sub>	-	3	5	mA	I <sub>O1</sub> =0mA, I <sub>O2</sub> =0mA
[3.3 V Output Block]						
Output voltage 1	V <sub>O1</sub>	3.234	3.300	3.366	V	I <sub>O1</sub> =50mA
Minimum output voltage difference 1	ΔV <sub>D1</sub>	-	1.1	1.3	V	I <sub>O1</sub> =1A, V <sub>CC</sub> =3.8V
Output current capacity 1	I <sub>O1</sub>	1.0	-	-	A	
Ripple rejection 1	R.R.1	46	52	-	dB	f=120Hz, ein=0.5Vp-p, I <sub>O1</sub> =5mA
Input stability 1	Reg.I1	-	5	15	mV	V <sub>CC</sub> =4.75→14V, I <sub>O1</sub> =5mA
Load stability 1	Reg.L1	-	5	20	mV	I <sub>O1</sub> =5mA→1A
Temperature coefficient of output voltage 1 <sup>*3</sup>	T <sub>CV01</sub>	-	±0.01	-	%/°C	I <sub>O1</sub> =5mA, Tj=0°C to 85°C
[1.5 V Output Block]						
Output voltage 2	V <sub>O2</sub>	1.470	1.500	1.530	V	I <sub>O2</sub> =50mA
Output current capacity 2	I <sub>O2</sub>	1.0	-	-	A	
Ripple rejection 2	R.R.2	46	52	-	dB	f=120Hz, ein=0.5Vp-p, I <sub>O2</sub> =5mA
Input stability 2	Reg.I2	-	5	15	mV	V <sub>CC</sub> =4.1→14V, I <sub>O2</sub> =5mA
Load stability 2	Reg.L2	-	5	20	mV	I <sub>O2</sub> =5mA→1A
Temperature coefficient of output voltage 2 <sup>*3</sup>	T <sub>CV02</sub>	-	±0.01	-	%/°C	I <sub>O2</sub> =5mA, Tj=0°C to 125°C

\*3: Not 100% tested.

## ●Electrical Characteristics - continued

BA33Dxx Series (Unless otherwise specified, Ta = 25°C, V<sub>CC</sub> = 5 V)

Parameter	Symbol	Limits			Unit	Conditions
		Min.	Typ.	Max.		
Bias current	I <sub>B</sub>	-	0.7	1.6	mA	I <sub>O1</sub> =0mA, I <sub>O2</sub> =0mA
[3.3V Output Block]						
Output voltage 1	V <sub>O1</sub>	3.234	3.300	3.366	V	I <sub>O1</sub> =250mA
Minimum output voltage difference 1	ΔV <sub>D1</sub>	-	0.25	0.50	V	I <sub>O1</sub> =250mA, V <sub>CC</sub> =3.135V
Output current capacity 1	I <sub>O1</sub>	0.5	-	-	A	
Ripple rejection 1	R.R.1	50	58	-	dB	f=120Hz, e <sub>in</sub> =1Vp-p, I <sub>O1</sub> =200mA
Input stability 1	Reg.I1	-	5	30	mV	V <sub>CC</sub> =4.1V→16V, I <sub>O1</sub> =250mA
Load stability 1	Reg.L1	-	30	75	mV	I <sub>O1</sub> =0mA→0.5A
Temperature coefficient of output voltage 1 <sup>*3</sup>	T <sub>CV01</sub>	-	±0.01	-	%/°C	I <sub>O1</sub> =5mA, T <sub>j</sub> =0°C to 125°C

BA33D15HFP V<sub>O2</sub> output

[1.5V Output Block]						
Output voltage 2	V <sub>O2</sub>	1.470	1.500	1.530	V	I <sub>O2</sub> =250mA
Output current capacity 2	I <sub>O2</sub>	0.5	-	-	A	
Ripple rejection 2	R.R.2	50	58	-	dB	f=120Hz, e <sub>in</sub> =1Vp-p, I <sub>O2</sub> =200mA
Input stability 2	Reg.I2	-	5	30	mV	V <sub>CC</sub> =4.1V→16V, I <sub>O2</sub> =250mA
Load stability 2	Reg.L2	-	30	75	mV	I <sub>O2</sub> =0mA→0.5A
Temperature coefficient of output voltage 2 <sup>*3</sup>	T <sub>CV02</sub>	-	±0.01	-	%/°C	I <sub>O2</sub> =5mA, T <sub>j</sub> =0°C to 125°C

BA33D18HFP V<sub>O2</sub> output

[1.8V Output Block]						
Output voltage 2	V <sub>O2</sub>	1.764	1.800	1.836	V	I <sub>O2</sub> =250mA
Output current capacity 2	I <sub>O2</sub>	0.5	-	-	A	
Ripple rejection 2	R.R.2	50	58	-	dB	f=120Hz, e <sub>in</sub> =1Vp-p, I <sub>O2</sub> =200mA
Input stability 2	Reg.I2	-	5	30	mV	V <sub>CC</sub> =4.1V→16V, I <sub>O2</sub> =250mA
Load stability 2	Reg.L2	-	30	75	mV	I <sub>O2</sub> =0mA→0.5A
Temperature coefficient of output voltage 2 <sup>*3</sup>	T <sub>CV02</sub>	-	±0.01	-	%/°C	I <sub>O2</sub> =5mA, T <sub>j</sub> =0°C to 125°C

\*3: Not 100% tested.

● Typical Performance Curves

BA3258HFP (Unless otherwise specified,  $T_a = 25^\circ\text{C}$ ,  $V_{CC} = 5\text{V}$ )

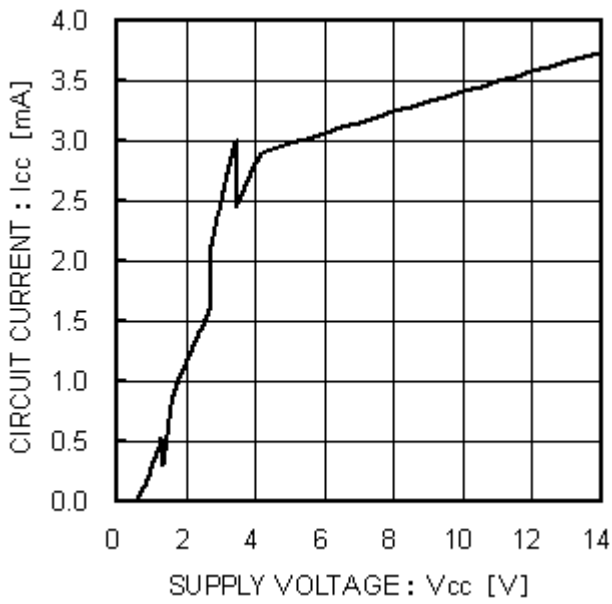

Fig.3  
Circuit Current  
(with no load)

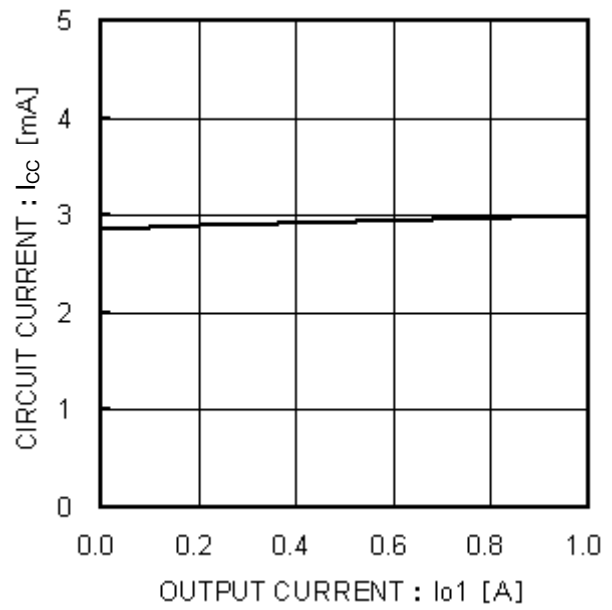

Fig.4  
Circuit Current vs. Load Current  $I_{O1}$   
( $I_{O1} = 0 \rightarrow 1\text{ A}$ )

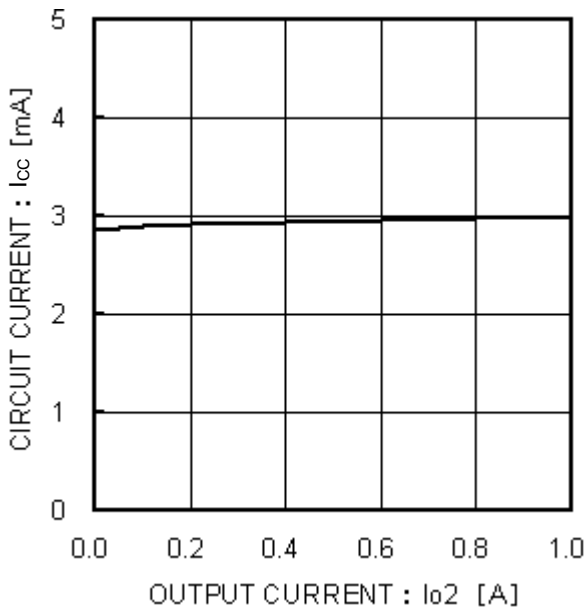

Fig.5  
Circuit Current vs. Load Current  $I_{O2}$   
( $I_{O2} = 0 \rightarrow 1\text{ A}$ )

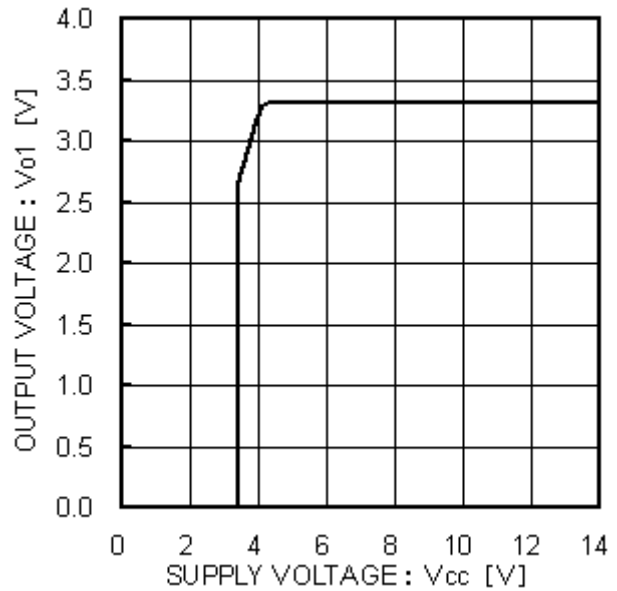

Fig.6  
Input Stability  
(3.3 V output with no load)

● Typical Performance Curves - continued

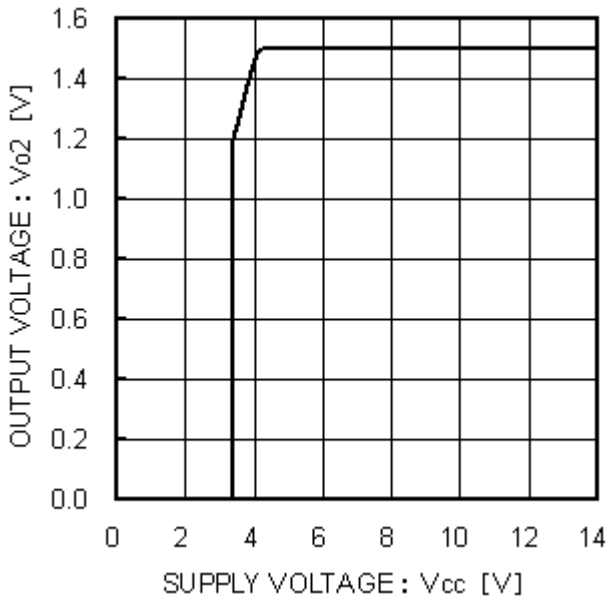

Fig.7  
Input Stability  
(1.5 V output with no load)

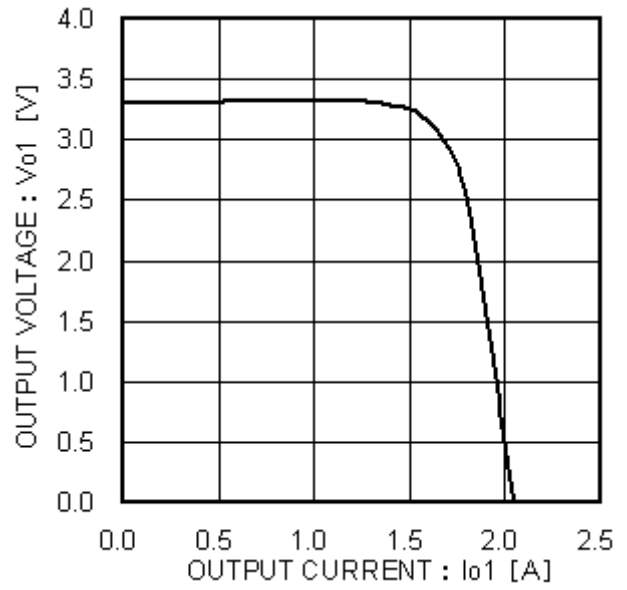

Fig.8  
Load Stability  
(3.3 V output)

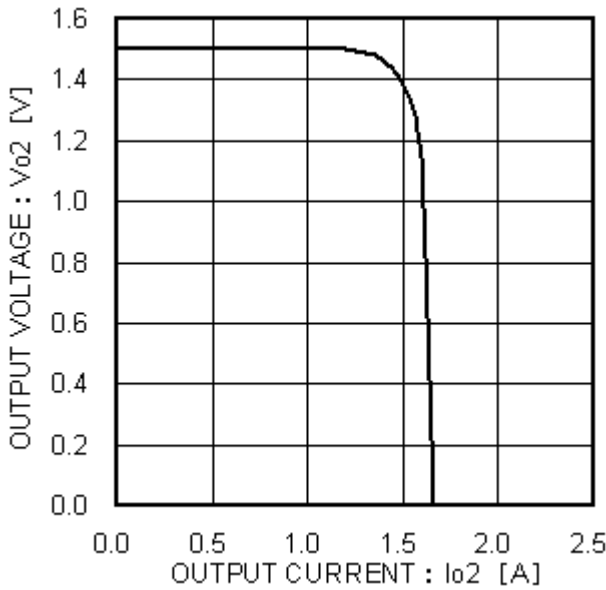

Fig.9  
Load Stability

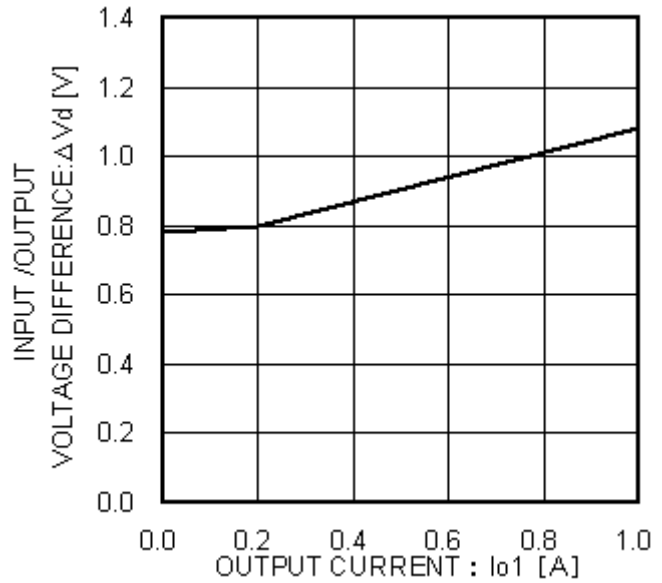

Fig.10  
I/O Voltage Difference (3.3 V output)  
(V<sub>CC</sub> = 3.8 V, I<sub>o1</sub> = 0 → 1 A)

● Typical Performance Curves - continued

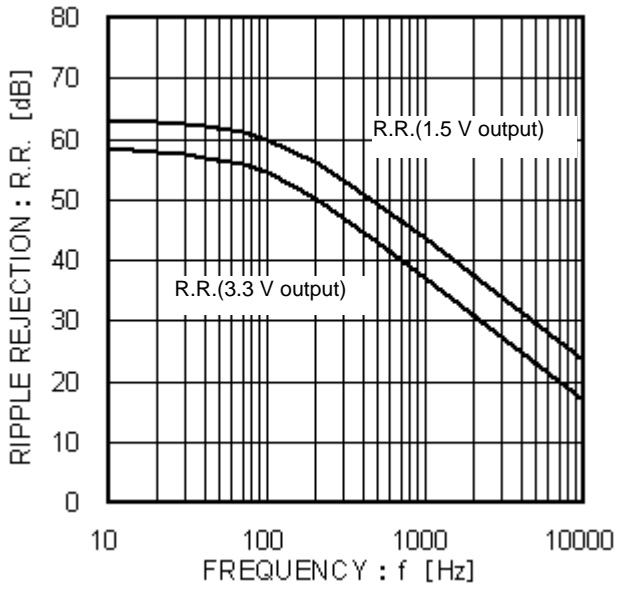

Fig.11  
R.R. Characteristics  
( $e_{in} = 0.5 V_{P-P}$ ,  $I_O = 5 mA$ )

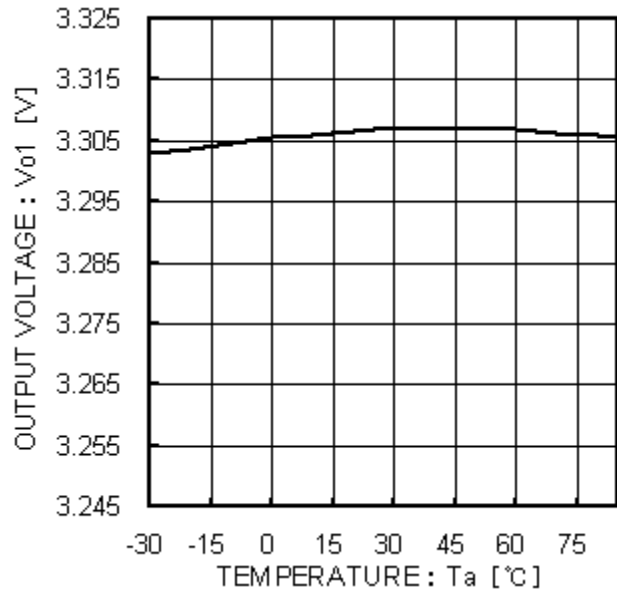

Fig.12  
Output Voltage vs Temperature  
(3.3 V output)

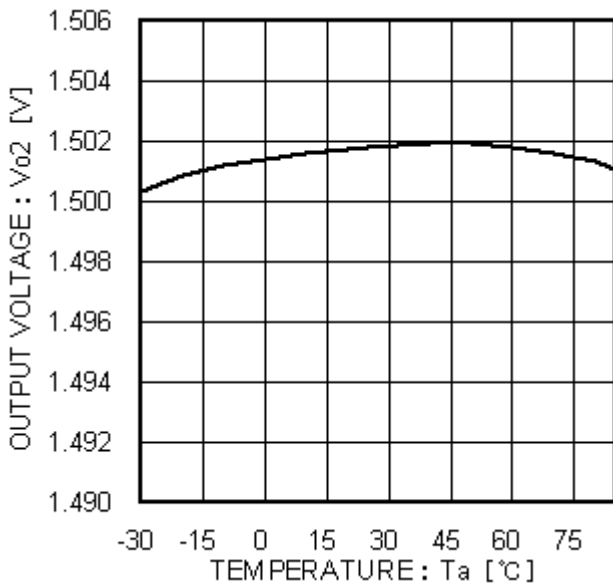

Fig.13  
Output Voltage vs Temperature  
(1.5 V output)

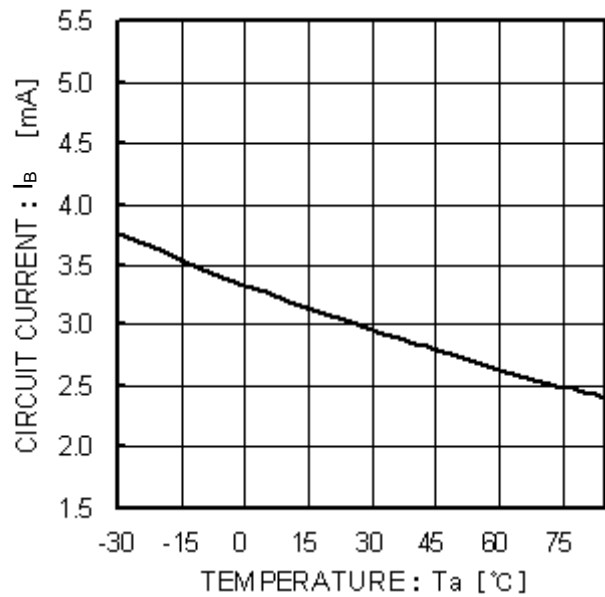

Fig.14  
Circuit Current vs Temperature  
( $I_O = 0 mA$ )

● Typical Performance Curves - continued

BA33D15HFP (Unless otherwise specified,  $T_a = 25^\circ\text{C}$ ,  $V_{CC} = 5\text{V}$ )

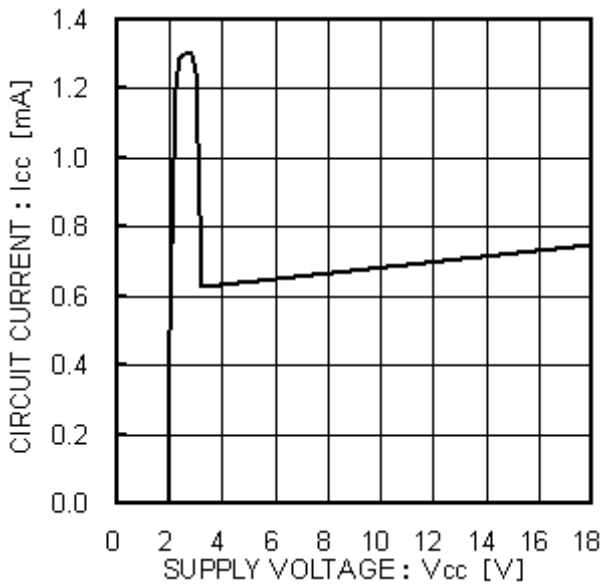

Fig.15  
Circuit Current  
(with no load)

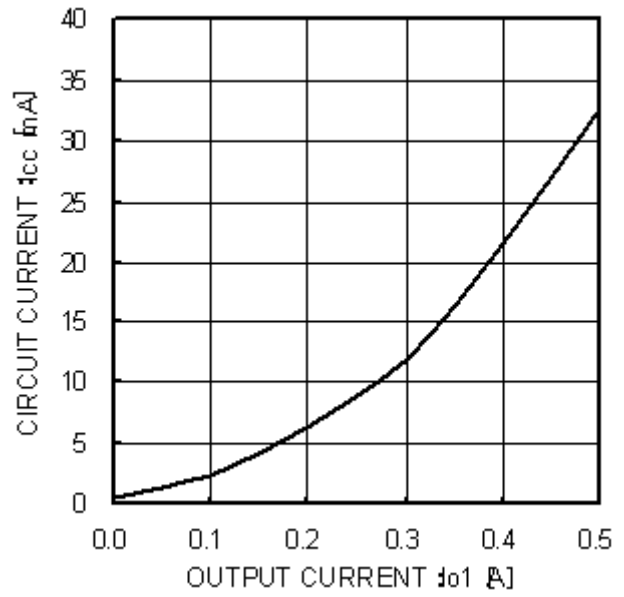

Fig.16  
Circuit Current vs Load Current  $I_{O1}$   
( $I_{O1} = 0 \rightarrow 500\text{ mA}$ )

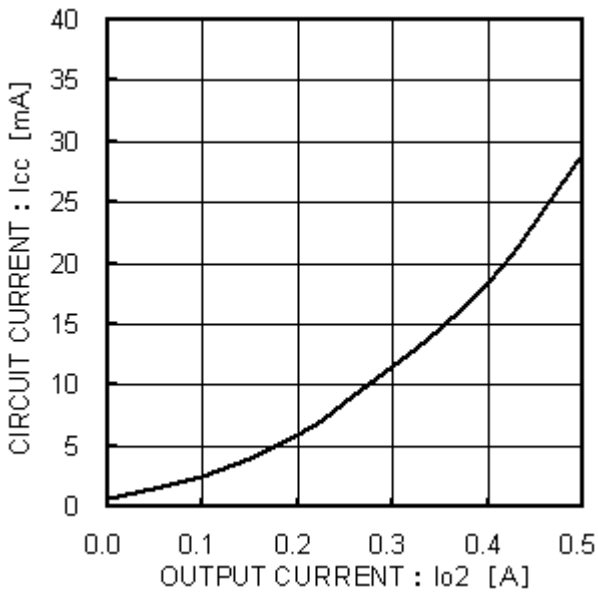

Fig.17  
Circuit Current vs Load Current  $I_{O2}$   
( $I_{O2} = 0 \rightarrow 500\text{ mA}$ )

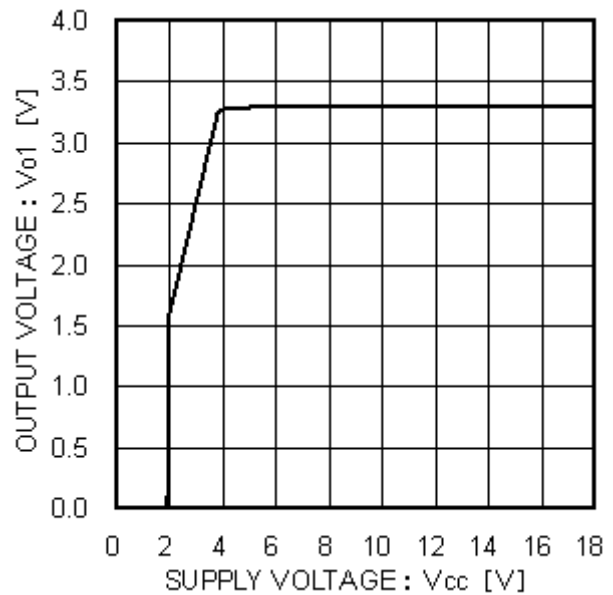

Fig.18  
Input Stability  
(3.3 V output,  $I_{O1} = 250\text{ mA}$ )



● Typical Performance Curves - continued

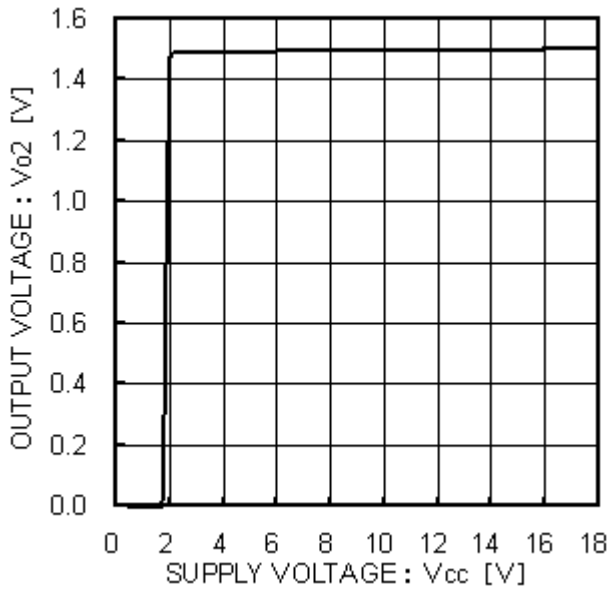

Fig.19  
Input Stability  
(1.5 V output,  $I_{o2} = 250$  mA)

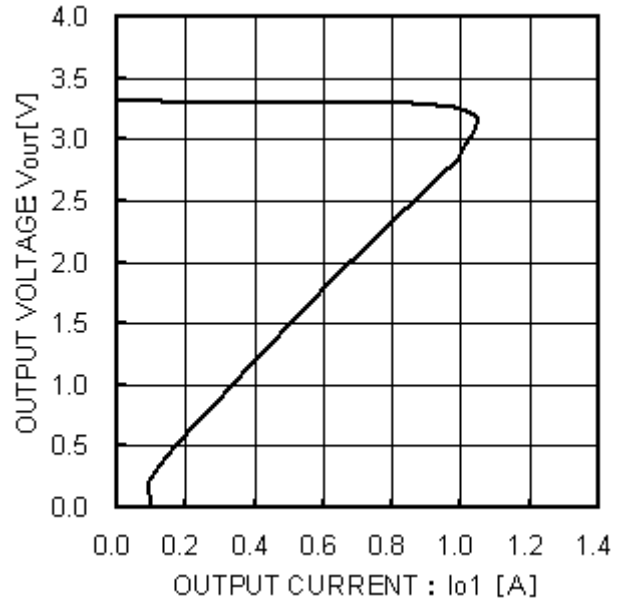

Fig.20  
Load Stability  
(3.3 V output)

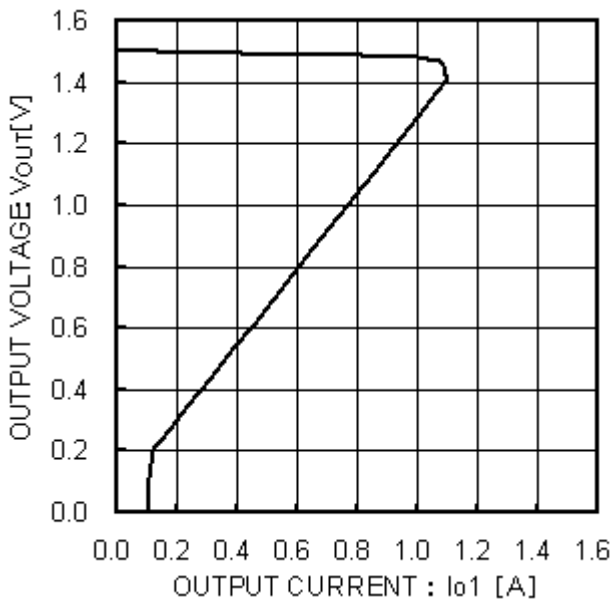

Fig.21  
Load Stability  
(1.5 V output)

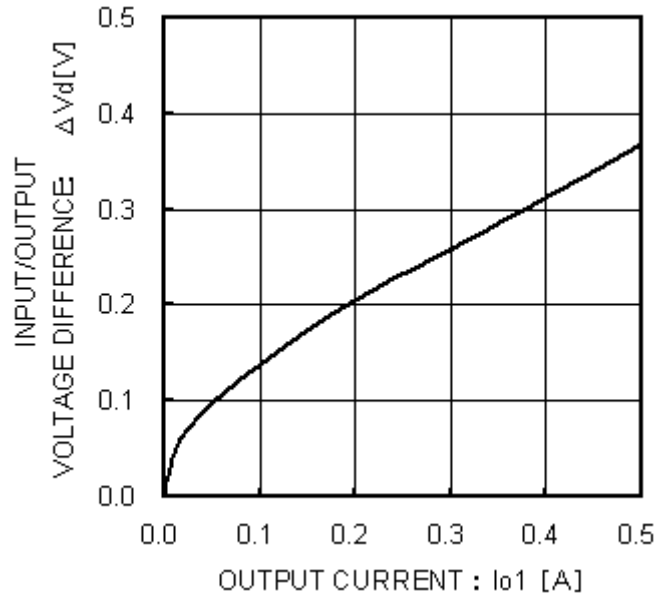

Fig.22  
I/O Voltage Difference  
( $V_{cc} = 3.135$  V, 3.3 V output)

● Typical Performance Curves - continued

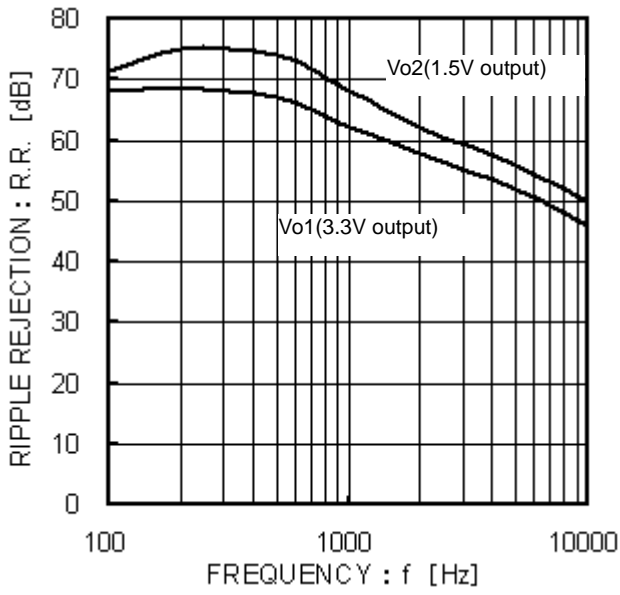

Fig.23  
R.R. Characteristics  
( $e_{in} = 1 V_{P-P}$ ,  $I_o = 100 mA$ )

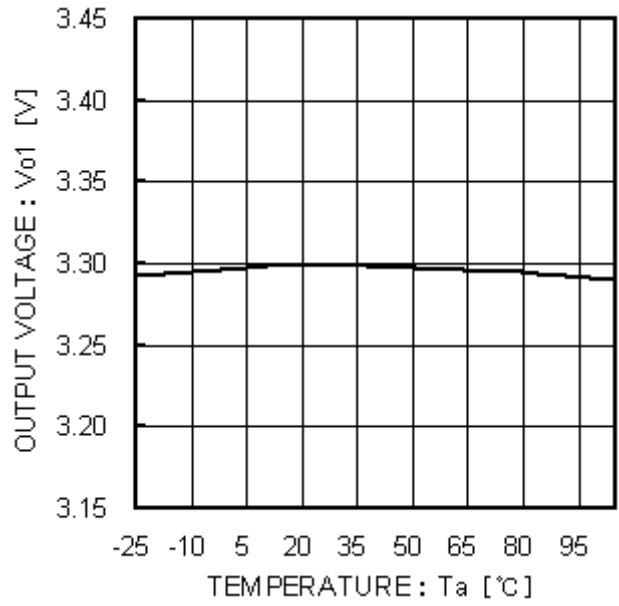

Fig.24  
Output Voltage vs. Temperature  
(3.3 V output)

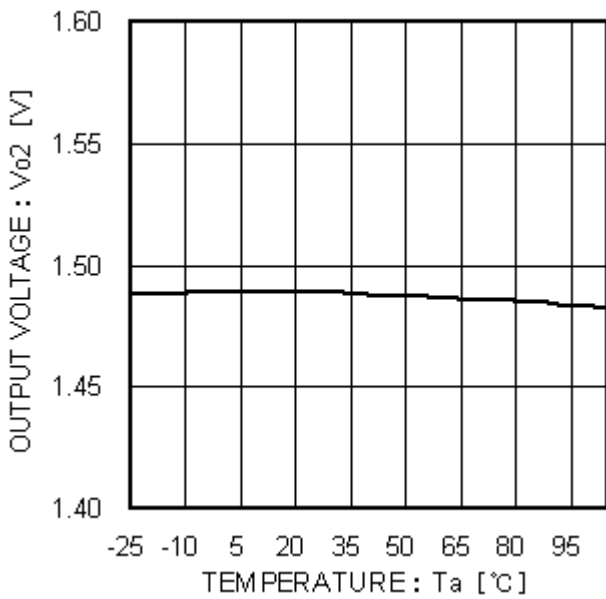

Fig.25  
Output Voltage vs. Temperature  
(1.5 V output)

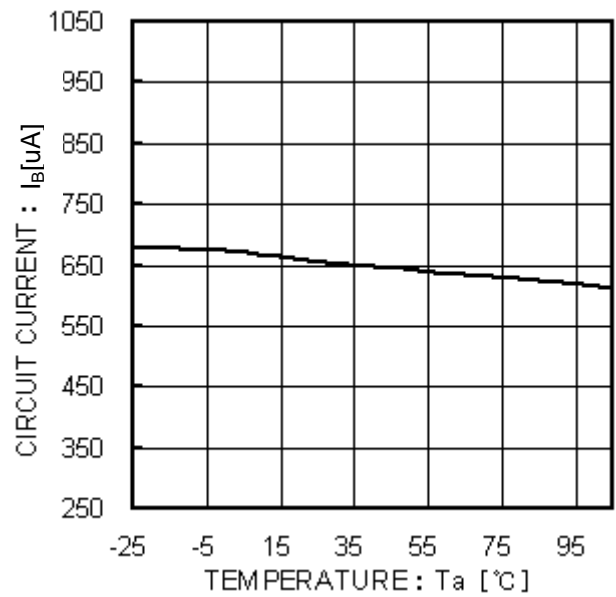

Fig.26  
Circuit Current vs Temperature  
( $I_o = 0 mA$ )

● I/O equivalence circuit  
BA3258HFP

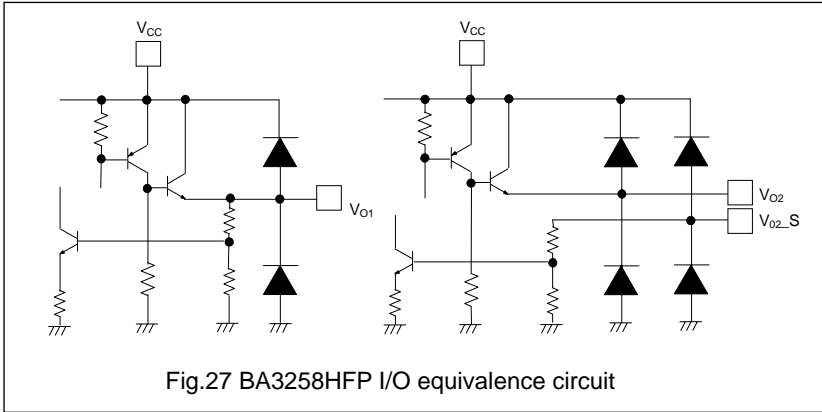

Fig.27 BA3258HFP I/O equivalence circuit

BA33DxxSeries

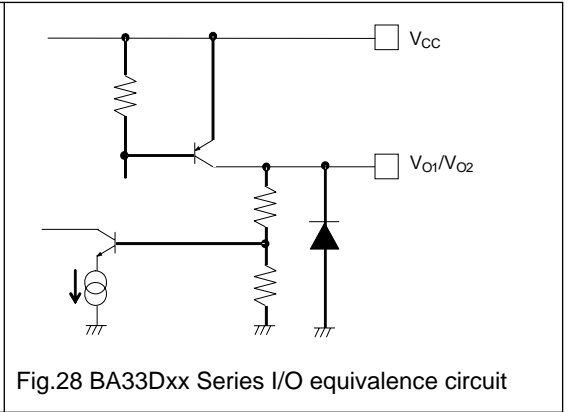

Fig.28 BA33Dxx Series I/O equivalence circuit

● Power Dissipation

If the IC is used under excessive power dissipation conditions, the chip temperature will rise, which will have an adverse effect on the electrical characteristics of the IC, such as a reduction in current capability. Furthermore, if the temperature exceeds Tjmax, element deterioration or damage may occur. Implement proper thermal designs to ensure that the power dissipation is within the permissible range in order to prevent instantaneous IC damage resulting from heat and maintain the reliability of the IC for long-term operation. Refer to the power derating characteristics curves in Fig.29.

- Power Consumption (Pc) Calculation Method

- Power consumption of 3.3V power transistor:

$$P_{C1} = (V_{CC} - 3.3) \times I_{O1}$$

- Power consumption of V<sub>O2</sub> power transistor:

$$P_{C2} = (V_{CC} - V_{O2}) \times I_{O2}$$

- Power consumption due to circuit current:

$$P_{C3} = V_{CC} \times I_{CC}$$

$$\rightarrow P_C = P_{C1} + P_{C2} + P_{C3}$$

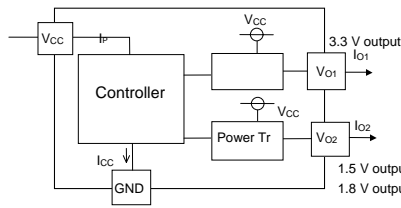

\*V<sub>CC</sub>: Applied voltage  
I<sub>O1</sub>: Load current on V<sub>O1</sub> side  
I<sub>O2</sub>: Load current on V<sub>O2</sub> side  
I<sub>CC</sub>: Circuit current  
\* The I<sub>CC</sub> (circuit current) varies with the load.  
(See reference data in Fig.4, 5, 16, and 17.)

Refer to the above and implement proper thermal designs so that the IC will not be used under excessive power dissipation conditions under the entire operating temperature range.

- Calculation example (BA33D15HFP)

Example: V<sub>CC</sub> = 5V, I<sub>O1</sub> = 200mA, and I<sub>O2</sub> = 100mA

- Power consumption of 3.3V power transistor:

$$P_{C1} = (V_{CC} - 3.3) \times I_{O1} = (5 - 3.3) \times 0.2 = 0.34W$$

- Power consumption of 1.5V power transistor:

$$P_{C2} = (V_{CC} - 1.5) \times I_{O2} = (5 - 1.5) \times 0.2 = 0.35W$$

- Power consumption due to circuit current:

$$P_{C3} = V_{CC} \times I_{CC} = 5 \times 0.0085 = 0.0425 (W) \text{ (See Fig.16 and 17)}$$

Implement proper thermal designs taking into consideration the dissipation at full power consumption (i.e., P<sub>C1</sub> + P<sub>C2</sub> + P<sub>C3</sub> = 0.34 + 0.35 + 0.0425 = 0.7325W).

●Explanation of External Components

OBA3258HFP

- 1) Pin 1 (V<sub>CC</sub> pin)  
Connecting a ceramic capacitor with a capacitance of approximately 3.3μF between V<sub>CC</sub> and GND as close to the pins as possible is recommended.
- 2) Pins 4 and 5 (V<sub>O</sub> pins)  
Insert a capacitor between the V<sub>O</sub> and GND pins in order to prevent output oscillation. The capacitor may oscillate if the capacitance changes as a result of temperature fluctuations. Therefore, it is recommended that a ceramic capacitor with a temperature coefficient of X5R or above and a maximum capacitance change (resulting from temperature fluctuations) of ±10% be used. The capacitance should be between 1μF and 1,000μF. (Refer to Fig.30)

OBA33DxxSeries

- 1) Pin 1 (V<sub>CC</sub> pin)  
Insert a 1μF capacitor between V<sub>CC</sub> and GND. The capacitance will vary depending on the application. Check the capacitance with the application set and implement designing with a sufficient margin.
- 2) Pins 4 and 5 (V<sub>O</sub> pins)  
Insert a capacitor between the V<sub>O</sub> and GND pins in order to prevent oscillation. The capacitance may vary greatly with temperature changes, thus making it impossible to completely prevent oscillation. Therefore, use a tantalum aluminum electrolytic capacitor with a low ESR (Equivalent Serial Resistance). The output will oscillate if the ESR is too high or too low, so refer to the ESR characteristics in Fig.31 and operate the IC within the stable operating region. If there is a sudden load change, use a capacitor with higher capacitance. A capacitance between 10μF and 1,000μF is recommended.

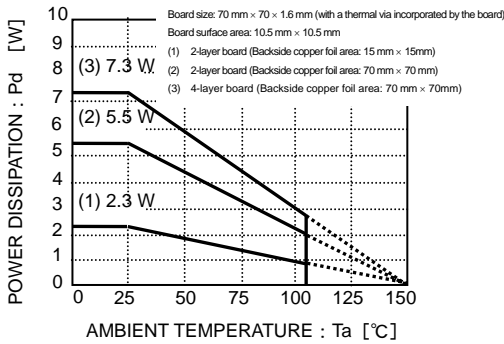

Fig.29 Thermal Derating Curves

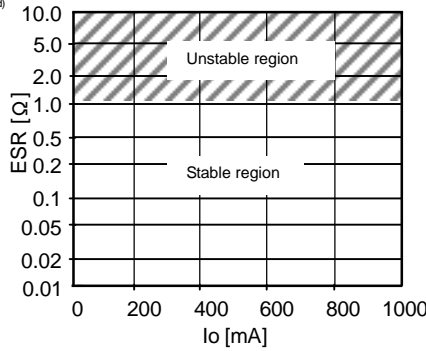

Fig.30 BA3258HFP ESR characteristics

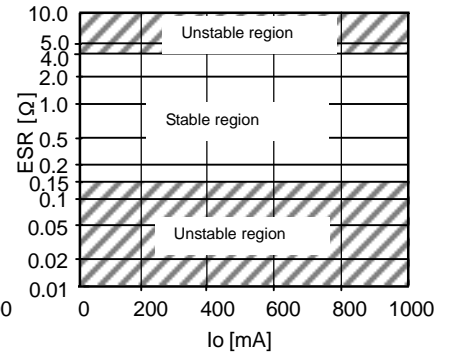

Fig.31 BA33Dxx Series ESR characteristics

●Operational Notes

- 1) Absolute maximum ratings  
An excess in the absolute maximum ratings, such as supply voltage, temperature range of operating conditions, etc., can break down the devices, thus making impossible to identify breaking mode, such as a short circuit or an open circuit. If any over rated values will expect to exceed the absolute maximum ratings, consider adding circuit protection devices, such as fuses.
- 2) GND voltage  
The potential of GND pin must be minimum potential in all operating conditions.
- 3) Thermal Design  
Use a thermal design that allows for a sufficient margin in light of the power dissipation (Pd) in actual operating conditions.
- 4) Inter-pin shorts and mounting errors  
Use caution when positioning the IC for mounting on printed circuit boards. The IC may be damaged if there is any connection error or if pins are shorted together.
- 5) Actions in strong electromagnetic field  
Use caution when using the IC in the presence of a strong electromagnetic field as doing so may cause the IC to malfunction.
- 6) Testing on application boards  
When testing the IC on an application board, connecting a capacitor to a pin with low impedance subjects the IC to stress. Always discharge capacitors after each process or step. Always turn the IC's power supply off before connecting it to or removing it from a jig or fixture during the inspection process. Ground the IC during assembly steps as an antistatic measure. Use similar precaution when transporting or storing the IC.
- 7) Regarding input pin of the IC  
This monolithic IC contains P+ isolation and P substrate layers between adjacent elements in order to keep them isolated. P-N junctions are formed at the intersection of these P layers with the N layers of other elements, creating a parasitic diode or transistor. For example, the relation between each potential is as follows:  
When  $GND > Pin A$  and  $GND > Pin B$ , the P-N junction operates as a parasitic diode.  
When  $GND > Pin B$ , the P-N junction operates as a parasitic transistor.  
Parasitic diodes can occur inevitable in the structure of the IC. The operation of parasitic diodes can result in mutual interference among circuits, operational faults, or physical damage. Accordingly, methods by which parasitic diodes operate, such as applying a voltage that is lower than the GND (P substrate) voltage to an input pin, should not be used.
- 8) Ground Wiring Pattern  
When using both small signal and large current GND patterns, it is recommended to isolate the two ground patterns, placing a single ground point at the ground potential of application so that the pattern wiring resistance and voltage variations caused by large currents do not cause variations in the small signal ground voltage. Be careful not to change the GND wiring pattern of any external components, either.
- 9) Thermal Shutdown Circuit (TSD)  
This IC incorporates a built-in thermal shutdown circuit for protection against thermal destruction. Should the junction temperature (Tj) reach the thermal shutdown ON temperature threshold, the TSD will be activated, turning off all output power elements. The circuit will automatically reset once the chip's temperature Tj drops below the threshold temperature. Operation of the thermal shutdown circuit presumes that the IC's absolute maximum ratings have been exceeded. Application designs should never make use of the thermal shutdown circuit.
- 10) Overcurrent protection circuit  
An overcurrent protection circuit is incorporated in order to prevention destruction due to short-time overload currents. Continued use of the protection circuits should be avoided. Please note that the current increases negatively impact the temperature.
- 11) Damage to the internal circuit or element may occur when the polarity of the V<sub>CC</sub> pin is opposite to that of the other pins in applications. (I.e. V<sub>CC</sub> is shorted with the GND pin while an external capacitor is charged.) Use a maximum capacitance of 1000 mF for the output pins. Inserting a diode to prevent back-current flow in series with V<sub>CC</sub> or bypass diodes between V<sub>CC</sub> and each pin is recommended.

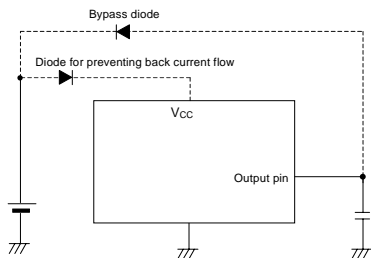

Fig.32 Bypass diode

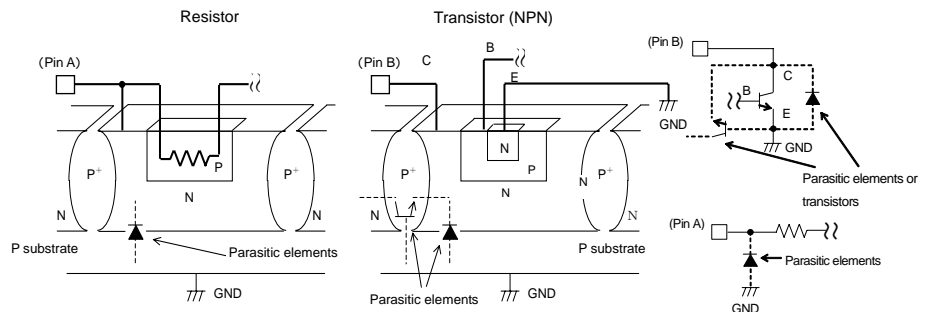

Fig.33 Example of Simple Bipolar IC Architecture

Status of this document

The Japanese version of this document is formal specification. A customer may use this translation version only for a reference to help reading the formal version.

If there are any differences in translation version of this document formal version takes priority.

●Physical Dimension Tape and Reel Information

HRP5

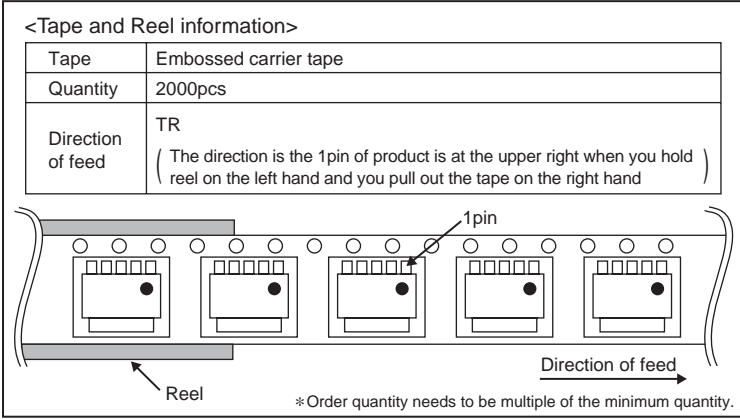
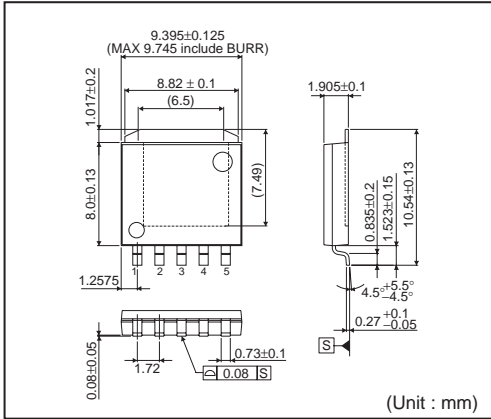

●Marking Diagram

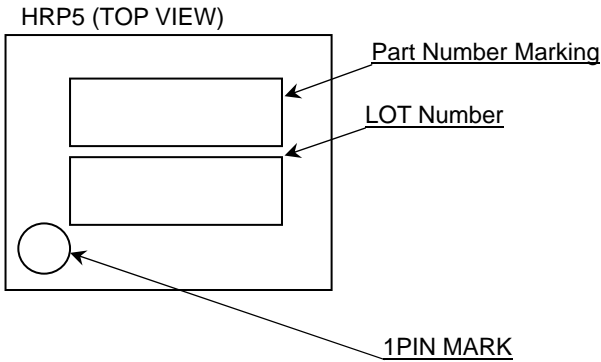

Part Number	Package	Part Number Marking
BA3258HFP	HRP5	BA3258
BA33D15HFP	HRP5	BA33D15
BA33D18HFP	HRP5	BA33D18

●Revision History

Date	Revision	Changes
26.Jun.2012	001	New Release

# Notice

## ●General Precaution

- 1) Before you use our Products, you are requested to carefully read this document and fully understand its contents. ROHM shall not be in any way responsible or liable for failure, malfunction or accident arising from the use of any ROHM's Products against warning, caution or note contained in this document.
- 2) All information contained in this document is current as of the issuing date and subject to change without any prior notice. Before purchasing or using ROHM's Products, please confirm the latest information with a ROHM sales representative.

## ●Precaution on using ROHM Products

- 1) Our Products are designed and manufactured for application in ordinary electronic equipments (such as AV equipment, OA equipment, telecommunication equipment, home electronic appliances, amusement equipment, etc.). If you intend to use our Products in devices requiring extremely high reliability (such as medical equipment, transport equipment, traffic equipment, aircraft/spacecraft, nuclear power controllers, fuel controllers, car equipment including car accessories, safety devices, etc.) and whose malfunction or failure may cause loss of human life, bodily injury or serious damage to property ("Specific Applications"), please consult with the ROHM sales representative in advance. Unless otherwise agreed in writing by ROHM in advance, ROHM shall not be in any way responsible or liable for any damages, expenses or losses incurred by you or third parties arising from the use of any ROHM's Products for Specific Applications.
- 2) ROHM designs and manufactures its Products subject to strict quality control system. However, semiconductor products can fail or malfunction at a certain rate. Please be sure to implement, at your own responsibilities, adequate safety measures including but not limited to fail-safe design against the physical injury, damage to any property, which a failure or malfunction of our Products may cause. The following are examples of safety measures:
  - [a] Installation of protection circuits or other protective devices to improve system safety
  - [b] Installation of redundant circuits to reduce the impact of single or multiple circuit failure
- 3) Our Products are designed and manufactured for use under standard conditions and not under any special or extraordinary environments or conditions, as exemplified below. Accordingly, ROHM shall not be in any way responsible or liable for any damages, expenses or losses arising from the use of any ROHM's Products under any special or extraordinary environments or conditions. If you intend to use our Products under any special or extraordinary environments or conditions (as exemplified below), your independent verification and confirmation of product performance, reliability, etc. prior to use, must be necessary:
  - [a] Use of our Products in any types of liquid, including water, oils, chemicals, and organic solvents
  - [b] Use of our Products outdoors or in places where the Products are exposed to direct sunlight or dust
  - [c] Use of our Products in places where the Products are exposed to sea wind or corrosive gases, including Cl<sub>2</sub>, H<sub>2</sub>S, NH<sub>3</sub>, SO<sub>2</sub>, and NO<sub>2</sub>
  - [d] Use of our Products in places where the Products are exposed to static electricity or electromagnetic waves
  - [e] Use of our Products in proximity to heat-producing components, plastic cords, or other flammable items
  - [f] Sealing or coating our Products with resin or other coating materials
  - [g] Use of our Products without cleaning residue of flux (even if you use no-clean type fluxes, cleaning residue of flux is recommended); or Washing our Products by using water or water-soluble cleaning agents for cleaning residue after soldering
  - [h] Use of the Products in places subject to dew condensation
- 4) The Products are not subject to radiation-proof design.
- 5) Please verify and confirm characteristics of the final or mounted products in using the Products.
- 6) In particular, if a transient load (a large amount of load applied in a short period of time, such as pulse) is applied, confirmation of performance characteristics after on-board mounting is strongly recommended. Avoid applying power exceeding normal rated power; exceeding the power rating under steady-state loading condition may negatively affect product performance and reliability.
- 7) De-rate Power Dissipation (Pd) depending on Ambient temperature (Ta). When used in sealed area, confirm the actual ambient temperature.
- 8) Confirm that operation temperature is within the specified range described in the product specification.
- 9) ROHM shall not be in any way responsible or liable for failure induced under deviant condition from what is defined in this document.



**●Precaution for Mounting / Circuit board design**

- 1) When a highly active halogenous (chlorine, bromine, etc.) flux is used, the residue of flux may negatively affect product performance and reliability.
- 2) In principle, the reflow soldering method must be used; if flow soldering method is preferred, please consult with the ROHM representative in advance.

For details, please refer to ROHM Mounting specification

**●Precautions Regarding Application Examples and External Circuits**

- 1) If change is made to the constant of an external circuit, please allow a sufficient margin considering variations of the characteristics of the Products and external components, including transient characteristics, as well as static characteristics.
- 2) You agree that application notes, reference designs, and associated data and information contained in this document are presented only as guidance for Products use. Therefore, in case you use such information, you are solely responsible for it and you must exercise your own independent verification and judgment in the use of such information contained in this document. ROHM shall not be in any way responsible or liable for any damages, expenses or losses incurred by you or third parties arising from the use of such information.

**●Precaution for Electrostatic**

This Product is electrostatic sensitive product, which may be damaged due to electrostatic discharge. Please take proper caution in your manufacturing process and storage so that voltage exceeding the Products maximum rating will not be applied to Products. Please take special care under dry condition (e.g. Grounding of human body / equipment / solder iron, isolation from charged objects, setting of Ionizer, friction prevention and temperature / humidity control).

**●Precaution for Storage / Transportation**

- 1) Product performance and soldered connections may deteriorate if the Products are stored in the places where:
  - [a] the Products are exposed to sea winds or corrosive gases, including Cl<sub>2</sub>, H<sub>2</sub>S, NH<sub>3</sub>, SO<sub>2</sub>, and NO<sub>2</sub>
  - [b] the temperature or humidity exceeds those recommended by ROHM
  - [c] the Products are exposed to direct sunshine or condensation
  - [d] the Products are exposed to high Electrostatic
- 2) Even under ROHM recommended storage condition, solderability of products out of recommended storage time period may be degraded. It is strongly recommended to confirm solderability before using Products of which storage time is exceeding the recommended storage time period.
- 3) Store / transport cartons in the correct direction, which is indicated on a carton with a symbol. Otherwise bent leads may occur due to excessive stress applied when dropping of a carton.
- 4) Use Products within the specified time after opening a humidity barrier bag. Baking is required before using Products of which storage time is exceeding the recommended storage time period.

**●Precaution for Product Label**

QR code printed on ROHM Products label is for ROHM's internal use only.

**●Precaution for Disposition**

When disposing Products please dispose them properly using an authorized industry waste company.

**●Precaution for Foreign Exchange and Foreign Trade act**

Since our Products might fall under controlled goods prescribed by the applicable foreign exchange and foreign trade act, please consult with ROHM representative in case of export.

**●Precaution Regarding Intellectual Property Rights**

- 1) All information and data including but not limited to application example contained in this document is for reference only. ROHM does not warrant that foregoing information or data will not infringe any intellectual property rights or any other rights of any third party regarding such information or data. ROHM shall not be in any way responsible or liable for infringement of any intellectual property rights or other damages arising from use of such information or data.:
- 2) No license, expressly or implied, is granted hereby under any intellectual property rights or other rights of ROHM or any third parties with respect to the information contained in this document.

●Other Precaution

- 1) The information contained in this document is provided on an "as is" basis and ROHM does not warrant that all information contained in this document is accurate and/or error-free. ROHM shall not be in any way responsible or liable for any damages, expenses or losses incurred by you or third parties resulting from inaccuracy or errors of or concerning such information.
- 2) This document may not be reprinted or reproduced, in whole or in part, without prior written consent of ROHM.
- 3) The Products may not be disassembled, converted, modified, reproduced or otherwise changed without prior written consent of ROHM.
- 4) In no event shall you use in any way whatsoever the Products and the related technical information contained in the Products or this document for any military purposes, including but not limited to, the development of mass-destruction weapons.
- 5) The proper names of companies or products described in this document are trademarks or registered trademarks of ROHM, its affiliated companies or third parties.