

# Low Power, Linear Phase 8th Order Lowpass Filter

## FEATURES

- Better Than Bessel Roll-Off
- $f_{\text{CUTOFF}}$  up to 20kHz, Single 5V Supply
- $I_{\text{SUPPLY}} = 2.5\text{mA}$  (Typ), Single 5V Supply
- 75dB THD + Noise with Single 5V Supply
- Phase and Group Delay Response Fully Tested
- Transient Response with No Ringing
- Wide Dynamic Range
- No External Components Needed
- Available in 14-Lead N and 16-Lead SW Packages

## APPLICATIONS

- Data Communication Filters
- Time Delay Networks
- Phase Matched Filters

LT, LTC and LT are registered trademarks of Linear Technology Corporation. All other trademarks are the property of their respective owners.

## DESCRIPTION

The LTC1164-7 is a low power, clock-tunable monolithic 8th order lowpass filter with linear passband phase and flat group delay. The amplitude response approximates a maximally flat passband and exhibits steeper roll-off than an equivalent 8th order Bessel filter. For instance, at twice the cutoff frequency the filter attains 34dB attenuation (vs 12dB for Bessel), while at three times the cutoff frequency the filter attains 68dB attenuation (vs 30dB for Bessel). The cutoff frequency of the LTC1164-7 is tuned via an external TTL or CMOS clock.

Low power is achieved without sacrificing dynamic range. With single 5V supply, the S/N + THD is up to 75dB. Optimum 91dB S/N is obtained with  $\pm 7.5\text{V}$  supplies.

The clock-to-cutoff frequency ratio of the LTC1164-7 can be set to 50:1 (Pin 10 to  $V^+$ ) or 100:1 (Pin 10 to  $V^-$ ).

When the filter operates at the clock-to-cutoff frequency ratio of 50:1, the input is double-sampled to lower the risk of aliasing.

The LTC1164-7 is pin-compatible with the LTC1064-X series and LTC1264-7.

## TYPICAL APPLICATION

10kHz Linear Phase Lowpass Filter

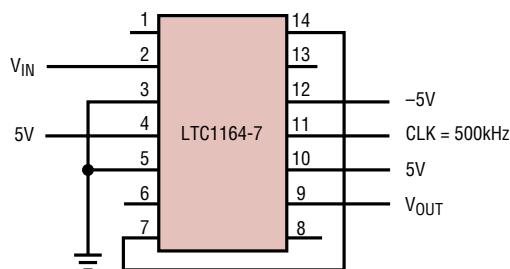

NOTE: THE POWER SUPPLIES SHOULD BE BYPASSED BY A 0.1 $\mu\text{F}$  CAPACITOR CLOSE TO THE PACKAGE AND ANY PRINTED CIRCUIT BOARD ASSEMBLY SHOULD MAINTAIN A DISTANCE OF AT LEAST 0.2 INCHES BETWEEN ANY OUTPUT OR INPUT PIN AND THE  $f_{\text{CLK}}$  LINE.

1164-7 TA01

Frequency Response

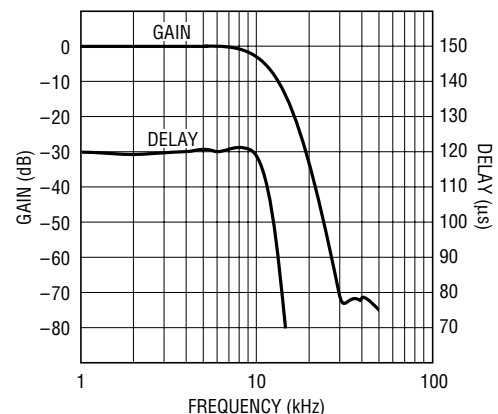

1164-7 TA02

# LTC1164-7

## ABSOLUTE MAXIMUM RATINGS (Note 1)

Total Supply Voltage ( $V^+$ to $V^-$ ) .....	16V	Operating Temperature Range	
Power Dissipation .....	400mW	LTC1164-7C .....	-40°C to 85°C
Burn-In Voltage .....	16V	LTC1164-7M .....	-55°C to 125°C
Voltage at Any Input ..... ( $V^- - 0.3V$ ) $\leq V_{IN} \leq (V^+ + 0.3V)$		Lead Temperature (Soldering, 10 sec) .....	300°C
Storage Temperature Range .....	-65°C to 150°C		

## PACKAGE/ORDER INFORMATION

<p>N PACKAGE 14-LEAD PLASTIC DIP</p> <p>J PACKAGE 14-LEAD CERAMIC DIP <math>T_{JMAX} = 150^\circ\text{C}</math>, <math>\theta_{JA} = 65^\circ\text{C/W}</math> (J) <b>OBSELETE PACKAGE</b> Consider the N Package as an Alternate Source</p>	<p>ORDER PART NUMBER</p> <p>LTC1164-7CN</p> <hr/> <p>LTC1164-7CJ LTC1164-7MJ</p>	<p>SW PACKAGE 16-LEAD PLASTIC SO (WIDE) <math>T_{JMAX} = 110^\circ\text{C}</math>, <math>\theta_{JA} = 85^\circ\text{C/W}</math></p>	<p>ORDER PART NUMBER</p> <p>LTC1164-7CSW</p>
<p><b>Order Options</b> Tape and Reel: Add #TR Lead Free: Add #PBF Lead Free Tape and Reel: Add #TRPBF Lead Free Part Marking: <a href="http://www.linear.com/leadfree/">http://www.linear.com/leadfree/</a></p> <p>Consult LTC Marketing for parts specified with wider operating temperature ranges.</p>			

**ELECTRICAL CHARACTERISTICS** The ● denotes the specifications which apply over the full operating temperature range, otherwise specifications are at  $T_A = 25^\circ\text{C}$ .  $V_S = \pm 7.5\text{V}$ ,  $R_L = 10\text{k}\Omega$ ,  $f_{CUTOFF} = 8\text{kHz}$  or  $4\text{kHz}$ ,  $f_{CLK} = 400\text{kHz}$ , TTL or CMOS level and all gain measurements are referenced to passband gain, unless otherwise specified. (Maximum clock rise or fall time  $\leq 1\mu\text{s}$ .) The filter cutoff frequency is abbreviated as  $f_{CUTOFF}$  or  $f_c$ .

PARAMETER	CONDITIONS	MIN	TYP	MAX	UNITS
Passband Gain	$0.1\text{Hz} \leq f \leq 0.25 f_{CUTOFF}$ $f_{TEST} = 2\text{kHz}$ , $(f_{CLK}/f_c) = 50:1$	● -0.50	-0.10	0.30	dB
Gain at $0.50 f_{CUTOFF}$	$f_{TEST} = 4\text{kHz}$ , $(f_{CLK}/f_c) = 50:1$ $f_{TEST} = 2\text{kHz}$ , $(f_{CLK}/f_c) = 100:1$	● -0.50 ● -0.85	-0.20 -0.65	0.30 0.15	dB dB
Gain at $0.75 f_{CUTOFF}$	$f_{TEST} = 6\text{kHz}$ , $(f_{CLK}/f_c) = 50:1$	● -1.2	-1.1	0.1	dB
Gain at $f_{CUTOFF}$	$f_{TEST} = 8\text{kHz}$ , $(f_{CLK}/f_c) = 50:1$ $f_{TEST} = 4\text{kHz}$ , $(f_{CLK}/f_c) = 100:1$	● -4.1 ● -5.5	-3.4 -5.2	-1.9 -2.5	dB dB
Gain at $2.0 f_{CUTOFF}$	$f_{TEST} = 16\text{kHz}$ , $(f_{CLK}/f_c) = 50:1$ $f_{TEST} = 8\text{kHz}$ , $(f_{CLK}/f_c) = 100:1$	● -37 ● -38	-34 -34	-30 -30	dB dB
Gain with $f_{CLK} = 20\text{kHz}$	$f_{TEST} = 200\text{Hz}$ , $(f_{CLK}/f_c) = 100:1$	-5.7	-5.2	-2.5	dB
Gain with $f_{CLK} = 400\text{kHz}$ , $V_S = \pm 2.375\text{V}$	$f_{TEST} = 4\text{kHz}$ , $(f_{CLK}/f_c) = 50:1$ $f_{TEST} = 8\text{kHz}$ , $(f_{CLK}/f_c) = 50:1$	-0.50 -3.75	-0.2 -3.4	0.2 -2.5	dB dB
Phase Factor ( $F$ ) Phase = $180^\circ - F(f/f_c)$ (Note 2)	$0.1\text{Hz} \leq f \leq f_{CUTOFF}$ $(f_{CLK}/f_c) = 50:1$ $(f_{CLK}/f_c) = 100:1$ $(f_{CLK}/f_c) = 50:1$ $(f_{CLK}/f_c) = 100:1$	● 430 ● 423	435 $\pm$ 2 428 $\pm$ 2	442 434	Deg Deg Deg Deg
Phase Nonlinearity (Note 2)	$(f_{CLK}/f_c) = 50:1$ $(f_{CLK}/f_c) = 100:1$ $(f_{CLK}/f_c) = 50:1$ $(f_{CLK}/f_c) = 100:1$	● ●	$\pm 1.0$ $\pm 1.0$	$\pm 2.0$ $\pm 2.5$	% % % %

11647b

**ELECTRICAL CHARACTERISTICS** The ● denotes the specifications which apply over the full operating temperature range, otherwise specifications are at  $T_A = 25^\circ\text{C}$ .  $V_S = \pm 7.5\text{V}$ ,  $R_L = 10\text{k}\Omega$ ,  $f_{\text{CUTOFF}} = 8\text{kHz}$  or  $4\text{kHz}$ ,  $f_{\text{CLK}} = 400\text{kHz}$ , TTL or CMOS level and all gain measurements are referenced to passband gain, unless otherwise specified. (Maximum clock rise or fall time  $\leq 1\mu\text{s}$ .) The filter cutoff frequency is abbreviated as  $f_{\text{CUTOFF}}$  or  $f_C$ .

PARAMETER	CONDITIONS	MIN	TYP	MAX	UNITS
Group Delay ( $t_d$ ) $t_d = (1/360)(f/f_C)$ (Note 3)	$(f_{\text{CLK}}/f_C) = 50:1, f \geq f_{\text{CUTOFF}}$		151.0 $\pm$ 1		$\mu\text{s}$
	$(f_{\text{CLK}}/f_C) = 100:1, f \geq f_{\text{CUTOFF}}$		297.2 $\pm$ 1		$\mu\text{s}$
	$(f_{\text{CLK}}/f_C) = 50:1, f \geq f_{\text{CUTOFF}}$ ●	149.3		153.5	$\mu\text{s}$
	$(f_{\text{CLK}}/f_C) = 100:1, f \geq f_{\text{CUTOFF}}$ ●	293.8		301.4	$\mu\text{s}$
Group Delay Deviation (Note 3)	$(f_{\text{CLK}}/f_C) = 50:1, f \geq f_{\text{CUTOFF}}$		$\pm 1.0$		%
	$(f_{\text{CLK}}/f_C) = 100:1, f \geq f_{\text{CUTOFF}}$		$\pm 1.0$		%
	$(f_{\text{CLK}}/f_C) = 50:1, f \geq f_{\text{CUTOFF}}$ ●			$\pm 2.0$	%
	$(f_{\text{CLK}}/f_C) = 100:1, f \geq f_{\text{CUTOFF}}$ ●			$\pm 2.5$	%
Input Frequency Range (Table 9)	$(f_{\text{CLK}}/f_C) = 50:1$		$< f_{\text{CLK}}$		kHz
	$(f_{\text{CLK}}/f_C) = 100:1$		$< f_{\text{CLK}}/2$		kHz
Maximum $f_{\text{CLK}}$	$V_S = \text{Single } 5\text{V (Pins 3 and 5 at } 2\text{V)}$		1		MHz
	$V_S = \pm 5\text{V}$		1		MHz
	$V_S = \pm 7.5\text{V}$		1		MHz
Clock Feedthrough ( $f = f_{\text{CLK}}$ )	50:1, $\pm 5\text{V}$ , Input at GND		100		$\mu\text{V}_{\text{RMS}}$
Wideband Noise ( $1\text{Hz} \leq f < f_{\text{CLK}}$ )	$V_S = \pm 2.5\text{V}$		95 $\pm$ 5%		$\mu\text{V}_{\text{RMS}}$
	$V_S = \pm 5\text{V}$		105 $\pm$ 5%		$\mu\text{V}_{\text{RMS}}$
	$V_S = \pm 7.5\text{V}$		115 $\pm$ 5%		$\mu\text{V}_{\text{RMS}}$
Input Impedance		35	55	90	k $\Omega$
Output DC Voltage Swing (Note 4)	$V_S = \pm 2.375\text{V}$	$\pm 1.25$	$\pm 1.4$		V
	$V_S = \pm 5\text{V}$ ●	$\pm 3.70$	$\pm 3.9$		V
	$V_S = \pm 7.5\text{V}$ ●	$\pm 5.40$	$\pm 6.1$		V
Output DC Offset	50:1, $V_S = \pm 5\text{V}$		$\pm 100$	$\pm 220$	mV
	100:1, $V_S = \pm 5\text{V}$		$\pm 100$		mV
Output DC Offset TempCo	50:1, $V_S = \pm 5\text{V}$		$\pm 200$		$\mu\text{V}/^\circ\text{C}$
	100:1, $V_S = \pm 5\text{V}$		$\pm 200$		$\mu\text{V}/^\circ\text{C}$
Power Supply Current	$V_S = \pm 2.375\text{V}, T_A = 25^\circ\text{C}$	●	2.5	4.0	mA
	$V_S = \pm 5\text{V}, T_A = 25^\circ\text{C}$	●	4.5	7.0	mA
	$V_S = \pm 7.5\text{V}, T_A = 25^\circ\text{C}$	●	7.0	11.0	mA
		●		12.5	mA
Power Supply Range		$\pm 2.375$		$\pm 8$	V

**Note 1:** Absolute Maximum Ratings are those values beyond which the life of a device may be impaired.

**Note 2:** Input frequencies,  $f$ , are linearly phase shifted through the filter as long as  $f \leq f_C$ ;  $f_C$  = cutoff frequency.

Figure 1 curve shows the typical phase response of an LTC1164-7 operating at  $f_{\text{CLK}} = 400\text{kHz}$ ,  $f_C = 8\text{kHz}$  and it closely matches an ideal straight line. The phase shift is described by: phase shift =  $180^\circ - F(f/f_C)$ ;  $f \leq f_C$ .

$F$  is arbitrarily called the "phase factor" expressed in degrees. The phase factor together with the specified deviation from the ideal straight line allows the calculation of the phase at a given frequency. Example: The phase shift at  $7\text{kHz}$  of the LTC1164-7 shown in Figure 1 is: phase shift =  $180^\circ - 434^\circ (7\text{kHz}/10\text{kHz}) \pm$  nonlinearity =  $-123.8^\circ \pm 1\%$  or  $-123.9^\circ \pm 1.24^\circ$ .

**Note 3:** Group delay and group delay deviation are calculated from the measured phase factor and phase deviation specifications.

**Note 4:** The AC swing is typically  $11\text{V}_{\text{P-P}}, 7\text{V}_{\text{P-P}}, 2.8\text{V}_{\text{P-P}}$  for  $\pm 7.5\text{V}, \pm 5\text{V}, \pm 2.5\text{V}$  supply respectively. For more information refer to the THD + Noise vs Input graphs.

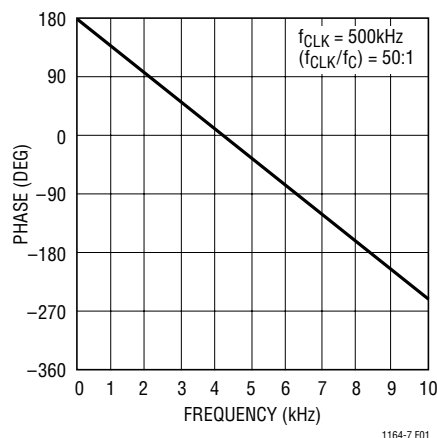
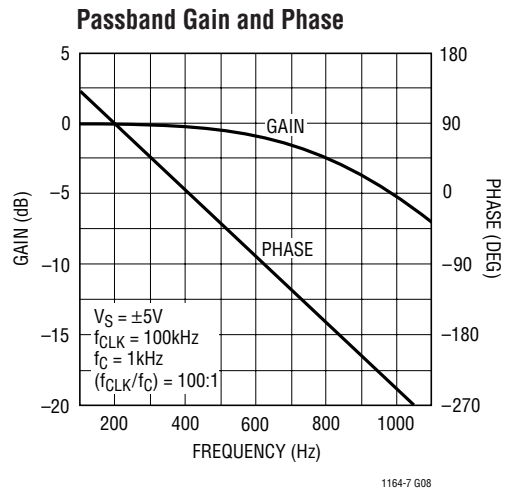
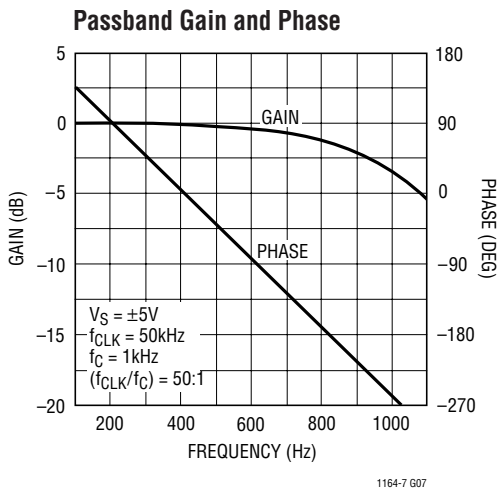
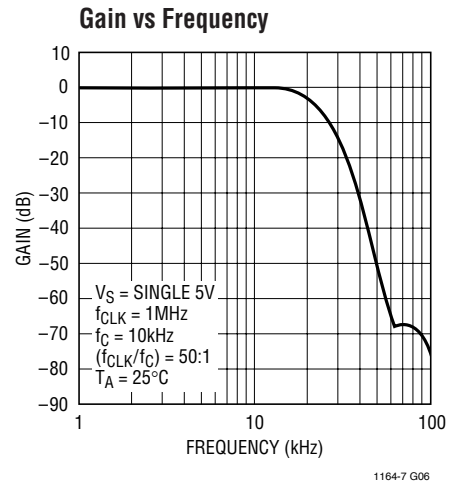
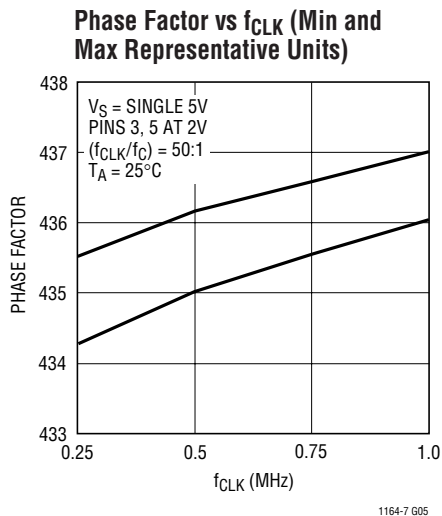
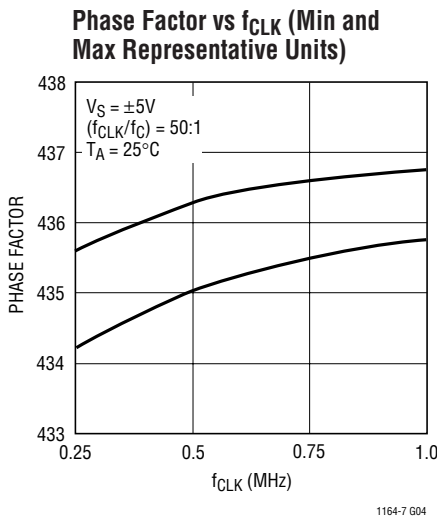
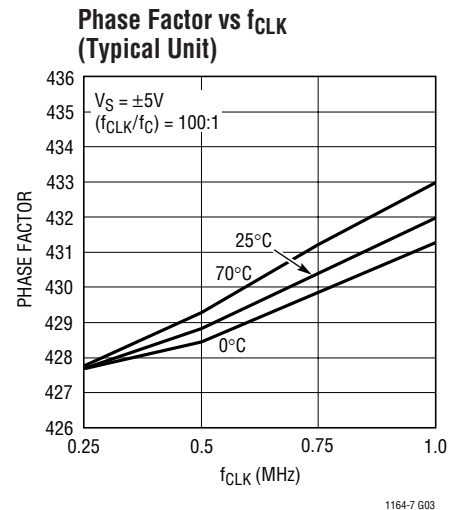
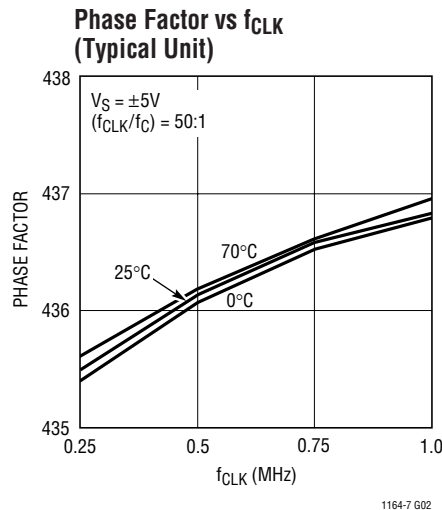
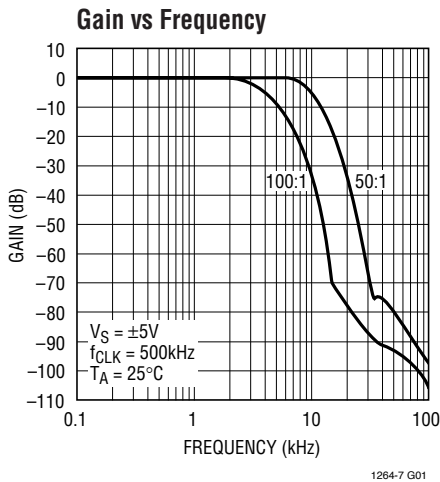

Figure 1. Phase Response in the Passband (Note 1)

**TYPICAL PERFORMANCE CHARACTERISTICS**



# TYPICAL PERFORMANCE CHARACTERISTICS

**Passband Gain vs Frequency and  $f_{CLK}$**

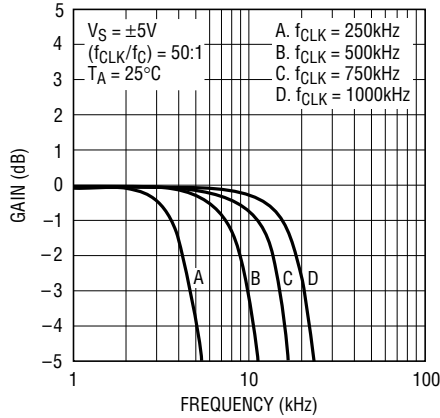

1164-7 G09

**Passband Gain vs Frequency and  $f_{CLK}$**

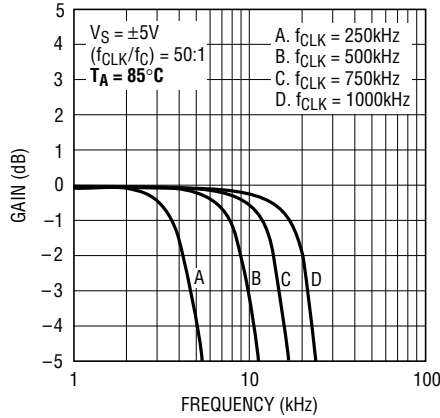

1164-7 G10

**Passband Gain vs Frequency and  $f_{CLK}$**

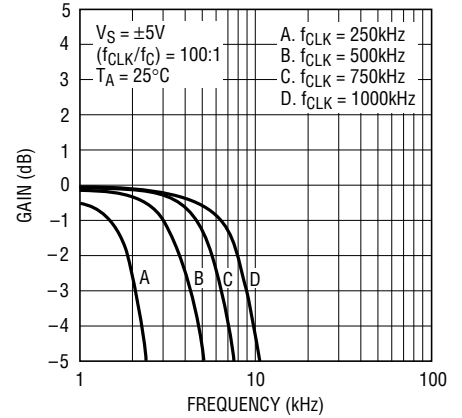

1164-7 G11

**Passband Gain vs Frequency and  $f_{CLK}$**

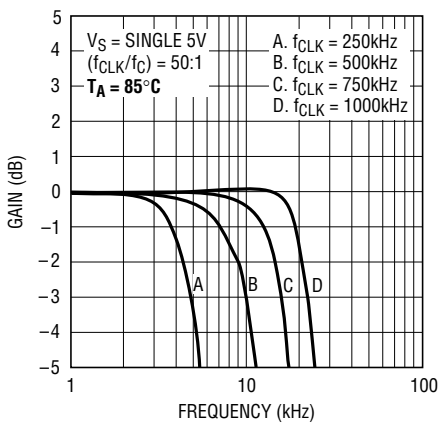

1164-7 G12

**Delay vs Frequency and  $f_{CLK}$**

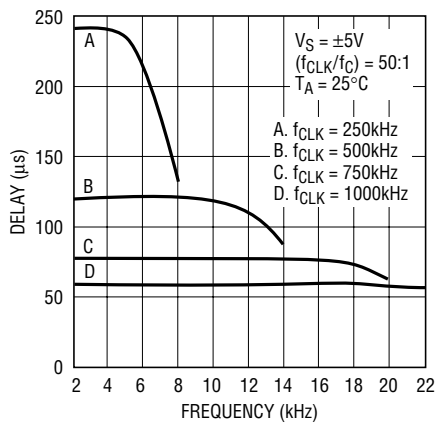

1264-7 G13

**Delay vs Frequency and  $f_{CLK}$**

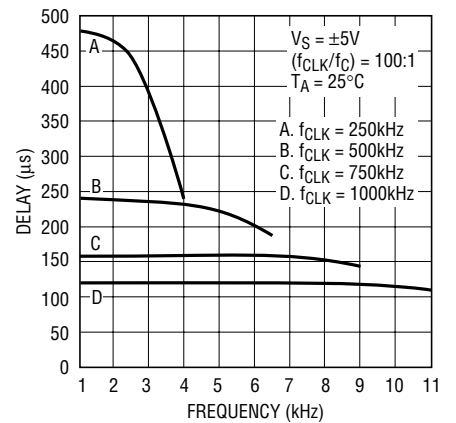

1264-7 G14

**THD + Noise vs Frequency**

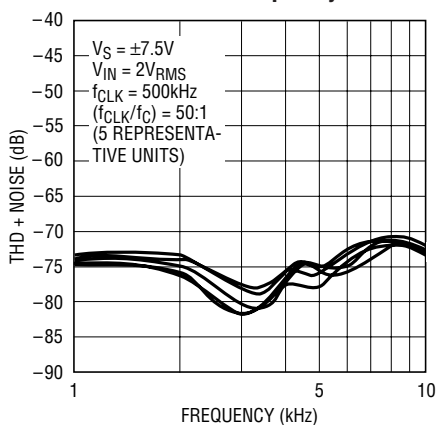

1164-7 G15

**THD + Noise vs Frequency**

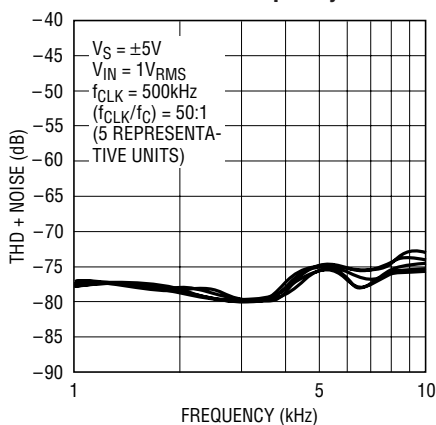

1164-7 G16

**THD + Noise vs Frequency**

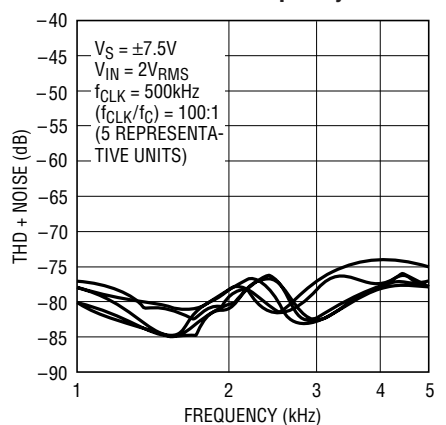

1164-7 G17

# TYPICAL PERFORMANCE CHARACTERISTICS

**THD + Noise vs Frequency**

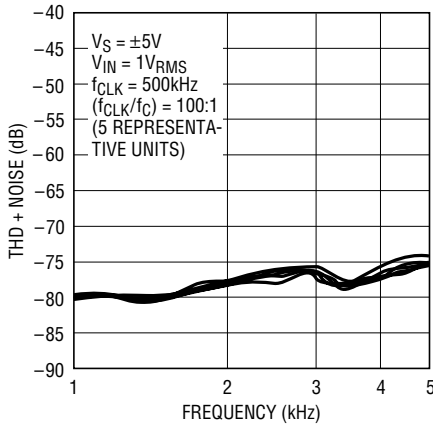

1164-7 G18

**THD + Noise vs Frequency**

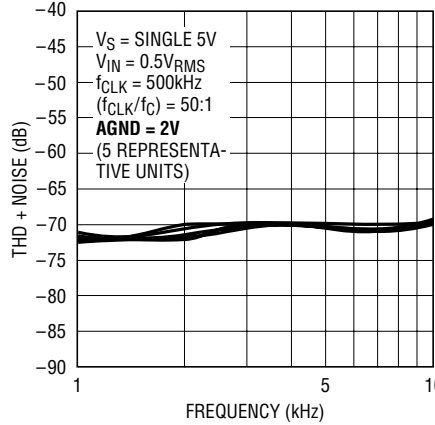

1164-7 G19

**THD + Noise vs Frequency**

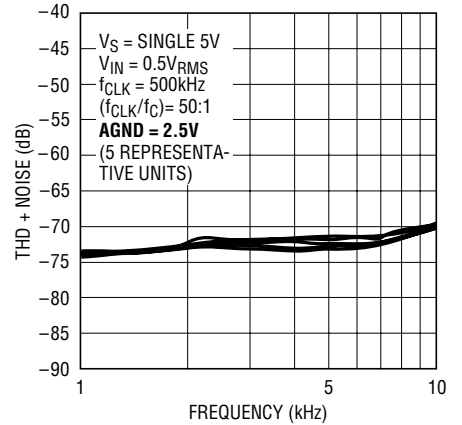

1164-7 G20

**THD + Noise vs Frequency**

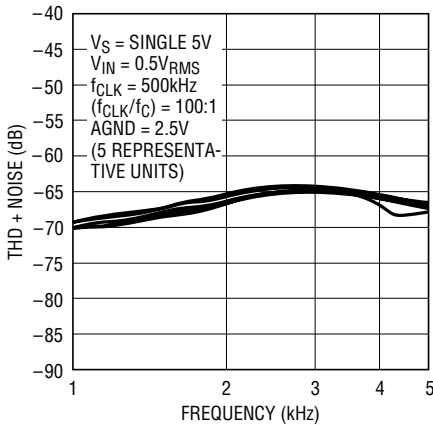

1164-7 G21

**THD + Noise vs Input**

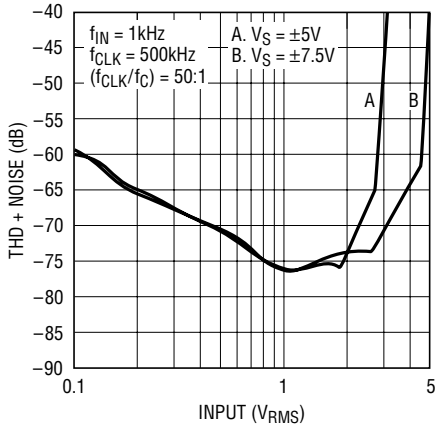

1164-7 G22

**THD + Noise vs Input**

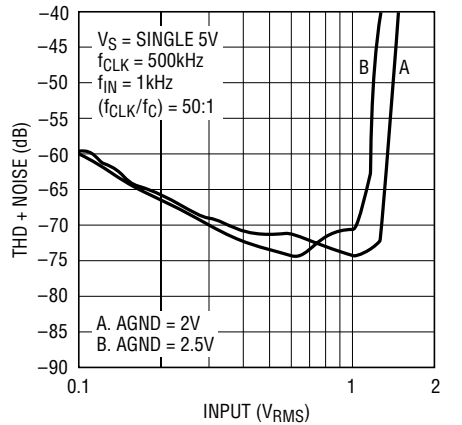

1164-7 G23

**THD + Noise vs Input**

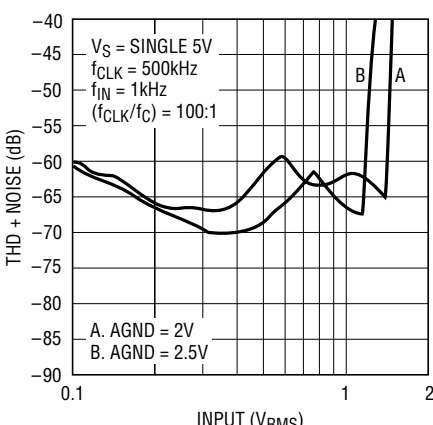

1164-7 G24

**Phase Matching vs Frequency**

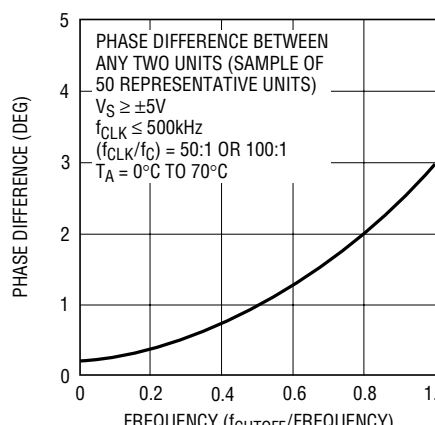

1164-7 G25

**Power Supply Current vs Power Supply Voltage**

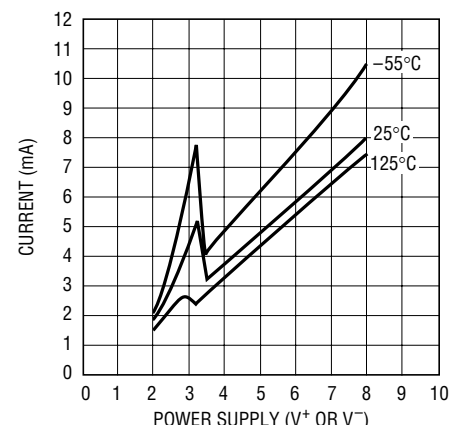

1164-7 G26

## TYPICAL PERFORMANCE CHARACTERISTICS

**Table 1. Passband Gain and Phase**  
 $V_S = \pm 7.5V$ , Ratio = 50:1,  $T_A = 25^\circ C$

FREQUENCY (kHz)	GAIN (dB)	PHASE (DEG)
<b>f<sub>CLK</sub> = 250kHz (Typical Unit)</b>		
0.000	-0.085	180.00
1.250	-0.085	71.51
2.500	-0.261	-37.31
3.750	-1.092	-146.38
5.000	-3.647	-255.45
<b>f<sub>CLK</sub> = 500kHz (Typical Unit)</b>		
0.000	-0.091	180.00
2.500	-0.091	71.36
5.000	-0.251	-37.57
7.500	-1.028	-146.78
10.000	-3.488	-256.16
<b>f<sub>CLK</sub> = 750kHz (Typical Unit)</b>		
0.000	-0.106	180.00
3.750	-0.106	71.26
7.500	-0.264	-37.65
11.250	-0.943	-146.88
15.000	-3.206	-256.58
<b>f<sub>CLK</sub> = 1MHz (Typical Unit)</b>		
0.000	-0.131	180.00
5.000	-0.131	71.11
10.000	-0.291	-37.71
15.000	-0.853	-146.87
20.000	-2.864	-256.81

**Table 3. Passband Gain and Phase**  
 $V_S = \pm 5V$ , Ratio = 50:1,  $T_A = 25^\circ C$

FREQUENCY (kHz)	GAIN (dB)	PHASE (DEG)
<b>f<sub>CLK</sub> = 250kHz (Typical Unit)</b>		
0.000	-0.071	180.00
1.250	-0.071	71.48
2.500	-0.243	-37.29
3.750	-1.068	-146.34
5.000	-3.609	-255.40
<b>f<sub>CLK</sub> = 500kHz (Typical Unit)</b>		
0.000	-0.081	180.00
2.500	-0.081	71.35
5.000	-0.236	-37.52
7.500	-0.981	-146.71
10.000	-3.371	-256.13
<b>f<sub>CLK</sub> = 750kHz (Typical Unit)</b>		
0.000	-0.105	180.00
3.750	-0.105	71.26
7.500	-0.261	-37.62
11.250	-0.883	-146.80
15.000	-3.008	-256.57
<b>f<sub>CLK</sub> = 1MHz (Typical Unit)</b>		
0.000	-0.134	180.00
5.000	-0.134	70.99
10.000	-0.292	-37.75
15.000	-0.771	-146.83
20.000	-2.571	-256.88

**Table 2. Passband Gain and Phase**  
 $V_S = \pm 7.5V$ , Ratio = 100:1,  $T_A = 25^\circ C$

FREQUENCY (kHz)	GAIN (dB)	PHASE (DEG)
<b>f<sub>CLK</sub> = 250kHz (Typical Unit)</b>		
0.000	-0.201	180.00
0.625	-0.201	71.39
1.250	-0.727	-36.79
1.875	-2.075	-143.66
2.500	-5.205	-247.79
<b>f<sub>CLK</sub> = 500kHz (Typical Unit)</b>		
0.000	-0.176	180.00
1.250	-0.176	71.34
2.500	-0.645	-36.88
3.750	-1.945	-143.93
5.000	-5.032	-248.52
<b>f<sub>CLK</sub> = 750kHz (Typical Unit)</b>		
0.000	-0.161	180.00
1.875	-0.161	71.32
3.750	-0.574	-37.04
5.625	-1.789	-144.45
7.500	-4.779	-249.82
<b>f<sub>CLK</sub> = 1MHz (Typical Unit)</b>		
0.000	-0.157	180.00
2.500	-0.157	71.23
5.000	-0.538	-37.28
7.500	-1.666	-145.02
10.000	-4.527	-251.13

**Table 4. Passband Gain and Phase**  
 $V_S = \pm 5V$ , Ratio = 100:1,  $T_A = 25^\circ C$

FREQUENCY (kHz)	GAIN (dB)	PHASE (DEG)
<b>f<sub>CLK</sub> = 250kHz (Typical Unit)</b>		
0.000	-0.189	180.00
0.625	-0.189	71.39
1.250	-0.707	-36.75
1.875	-2.048	-143.60
2.500	-5.711	-247.74
<b>f<sub>CLK</sub> = 500kHz (Typical Unit)</b>		
0.000	-0.159	180.00
1.250	-0.159	71.35
2.500	-0.603	-36.85
3.750	-1.872	-144.00
5.000	-4.926	-248.80
<b>f<sub>CLK</sub> = 750kHz (Typical Unit)</b>		
0.000	-0.149	180.00
1.875	-0.149	71.28
3.750	-0.536	-37.13
5.625	-1.704	-144.72
7.500	-4.621	-250.48
<b>f<sub>CLK</sub> = 1MHz (Typical Unit)</b>		
0.000	-0.151	180.00
2.500	-0.151	71.10
5.000	-0.511	-37.52
7.500	-1.581	-145.45
10.000	-4.336	-252.01

## TYPICAL PERFORMANCE CHARACTERISTICS

**Table 5. Passband Gain and Phase**  
 $V_S = \text{Single } 5V$ , Ratio = 50:1,  $T_A = 25^\circ\text{C}$

FREQUENCY (kHz)	GAIN (dB)	PHASE (DEG)
<b><math>f_{\text{CLK}} = 250\text{kHz}</math> (Typical Unit)</b>		
0.000	-0.085	180.00
1.250	-0.085	71.54
2.500	-0.252	-37.15
3.750	-1.056	-146.12
5.000	-3.562	-255.22
<b><math>f_{\text{CLK}} = 500\text{kHz}</math> (Typical Unit)</b>		
0.000	-0.101	180.00
2.500	-0.101	71.39
5.000	-0.251	-37.38
7.500	-0.947	-146.44
10.000	-3.252	-256.02
<b><math>f_{\text{CLK}} = 750\text{kHz}</math> (Typical Unit)</b>		
0.000	-0.133	180.00
3.750	-0.133	71.16
7.500	-0.291	-37.56
11.250	-0.826	-146.55
15.000	-2.789	-256.52
<b><math>f_{\text{CLK}} = 1\text{MHz}</math> (Typical Unit)</b>		
0.000	-0.162	180.00
5.000	-0.162	70.89
10.000	-0.307	-37.78
15.000	-0.647	-146.67
20.000	-2.201	-257.06

**Table 6. Passband Gain and Phase**  
 $V_S = \text{Single } 5V$ , Ratio = 100:1,  $T_A = 25^\circ\text{C}$

FREQUENCY (kHz)	GAIN (dB)	PHASE (DEG)
<b><math>f_{\text{CLK}} = 250\text{kHz}</math> (Typical Unit)</b>		
0.000	-0.283	180.00
0.625	-0.283	71.35
1.250	-0.799	-37.01
1.875	-2.143	-143.96
2.500	-5.271	-248.03
<b><math>f_{\text{CLK}} = 500\text{kHz}</math> (Typical Unit)</b>		
0.000	-0.252	180.00
1.250	-0.252	71.28
2.500	-0.676	-37.16
3.750	-1.917	-144.46
5.000	-4.936	-249.40
<b><math>f_{\text{CLK}} = 750\text{kHz}</math> (Typical Unit)</b>		
0.000	-0.231	180.00
1.875	-0.231	70.94
3.750	-0.603	-37.72
5.625	-1.704	-145.55
7.500	-4.535	-251.81
<b><math>f_{\text{CLK}} = 1\text{MHz}</math> (Typical Unit)</b>		
0.000	-0.212	180.00
2.500	-0.212	70.83
5.000	-0.532	-38.11
7.500	-1.497	-146.47
10.000	-4.115	-253.92



## PIN FUNCTIONS

**NC (Pins 1, 8, 13):** Pins 1, 8 and 13 are not connected to any internal circuit point on the device and should be preferably tied to analog ground.

**Filter Input (Pin 2):** The input pin is connected internally through a 50k resistor tied to the inverting input of an op amp.

**Analog GND (Pins 3, 5):** The filter performance depends on the quality of the analog signal ground. For either dual or single supply operation, an analog ground plane surrounding the package is recommended. The analog ground plane should be connected to any digital ground at a single point. For dual supply operation, Pins 3 and 5 should be connected to the analog ground plane. For single supply operation, Pins 3 and 5 should be biased at 1/2 supply and should be bypassed to the analog ground plane with at least a 1 $\mu$ F capacitor (Figure 3). For single 5V operation at the highest  $f_{CLK}$  of 2MHz, Pins 3 and 5 should be biased at 2V. This minimizes passband gain and phase variations.

**Power Supply (Pins 4, 12):** The  $V^+$  (pin 4) and the  $V^-$  (Pin 12) should each be bypassed with a 0.1 $\mu$ F capacitor to an adequate analog ground. The filter's power supplies should be isolated from other digital or high voltage analog supplies. A low noise linear supply is recommended. Using a switching power supply will lower the signal-to-noise ratio of the filter. The supply during power-up should have a slew rate less than 1V/ $\mu$ s. When  $V^+$  is applied before  $V^-$  and  $V^-$  is allowed to go above ground, a signal diode should clamp  $V^-$  to prevent latch-up. Figures 2 and 3 show typical connections for dual and single supply operation.

**Filter Output (Pins 6, 9):** Pin 6 is an intermediate filter output providing an unspecified 6th order lowpass filter. Pin 6 should not be loaded. Pin 9 is the specified output of the filter; it can typically source/sink 1mA. Driving coaxial cables or resistive loads less than 20k will degrade the total harmonic distortion of the filter. When evaluating the device's distortion an output buffer is required. A noninverting buffer, Figure 4, can be used provided that its input common-mode range is well within the filter's output swing.

**External Connection (Pins 7, 14):** Pins 7 and 14 should be connected together. In a printed circuit board the connection should be done under the IC package through a short trace surrounded by the analog ground plane.

**Ratio Input (Pin 10):** The DC level at this pin determines the ratio of the clock frequency to the cutoff frequency of the filter. Pin 10 at  $V^+$  gives a 50:1 ratio and pin 10 at  $V^-$  gives a 100:1 ratio. For single supply operation the ratio is 50:1 when Pin 10 is at  $V^+$  and 100:1 when Pin 10 is at ground. When Pin 10 is not tied to ground, it should be bypassed to analog ground with a 0.1 $\mu$ F capacitor. If the DC level at Pin 10 is switched mechanically or electrically at slew rates greater than 1V/ $\mu$ s while the device is operating, a 10k resistor should be connected between pin 10 and the DC source.

**Clock Input (Pin 11):** Any TTL or CMOS clock source with a square-wave output and 50% duty cycle ( $\pm 10\%$ ) is an adequate clock source for the device. The power supply for the clock source should not be the filter's power supply. The analog ground for the filter should be connected to clock's ground at a single point only. Table 7 shows the clock's low and high level threshold values for dual or single supply operation. A pulse generator can be used as a clock source provided the high level ON time is greater than 0.5 $\mu$ s. Sine waves are not recommended for clock input frequencies less than 100kHz, since excessively slow clock rise or fall times generate internal clock jitter (maximum clock rise or fall time  $\leq 1\mu$ s). The clock signal should be routed from the right side of the IC package and perpendicular to it to avoid coupling to any input or output analog signal path. A 1k resistor between clock source and Pin 11 will slow down the rise and fall times of the clock to further reduce charge coupling (Figures 2 and 3).

**Table 7. Clock Source High and Low Threshold Levels**

POWER SUPPLY	HIGH LEVEL	LOW LEVEL
Dual Supply = $\pm 7.5V$	$\geq 2.18V$	$\leq 0.5V$
Dual Supply = $\pm 5V$	$\geq 1.45V$	$\leq 0.5V$
Dual Supply = $\pm 2.5V$	$\geq 0.73V$	$\leq -2.0V$
Single Supply = 12V	$\geq 7.80V$	$\leq 6.5V$
Single Supply = 5V	$\geq 1.45V$	$\leq 0.5V$

**PIN FUNCTIONS**

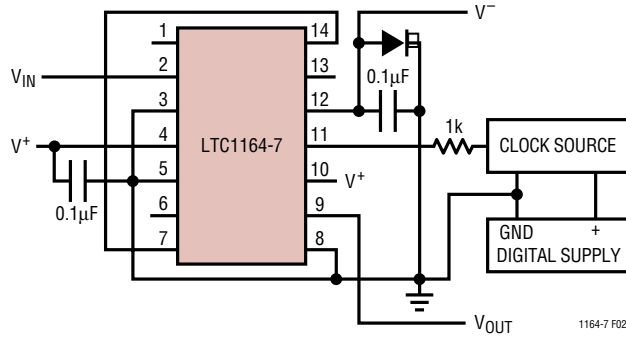

**Figure 2. Dual Supply Operation for an  $f_{CLK}/f_{CUTOFF} = 50:1$**

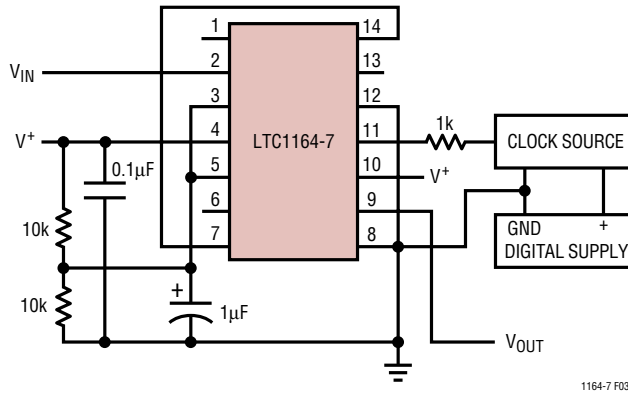

**Figure 3. Single Supply Operation for an  $f_{CLK}/f_{CUTOFF} = 50:1$**

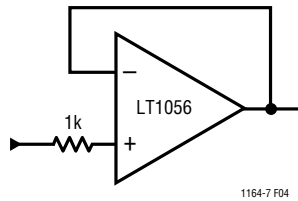

**Figure 4. Buffer for Filter Output**

## APPLICATIONS INFORMATION

### Clock Feedthrough

Clock feedthrough is defined as the RMS value of the clock frequency and its harmonics that are present at the filter's output pin (9). The clock feedthrough is tested with the input pin (2) grounded and it depends on PC board layout and on the value of the power supplies. With proper layout techniques the values of the clock feedthrough are shown in Table 8.

**Table 8. Clock Feedthrough**

V <sub>S</sub>	50:1	100:1
Single 5V	70 $\mu$ V <sub>RMS</sub>	70 $\mu$ V <sub>RMS</sub>
$\pm$ 5V	100 $\mu$ V <sub>RMS</sub>	200 $\mu$ V <sub>RMS</sub>
$\pm$ 7.5V	120 $\mu$ V <sub>RMS</sub>	500 $\mu$ V <sub>RMS</sub>

Note: The clock feedthrough at Single 5V is imbedded in the wideband noise of the filter. The clock waveform is a square wave.

Any parasitic switching transients during the rise and fall edges of the incoming clock are not part of the clock feedthrough specifications. Switching transients have frequency contents much higher than the applied clock; their amplitude strongly depends on scope probing techniques as well as grounding and power supply bypassing. The clock feedthrough, if bothersome, can be greatly reduced by adding a simple R/C lowpass network at the output of the filter pin (9). This R/C will completely eliminate any switching transients.

### Wideband Noise

The wideband noise of the filter is the total RMS value of the device's noise spectral density and it is used to determine the operating signal-to-noise ratio. Most of its frequency contents lie within the filter's passband and cannot be reduced with post filtering. For instance, the

LTC1164-7 wideband noise at  $\pm$ 5V supply is 105 $\mu$ V<sub>RMS</sub>, 95 $\mu$ V<sub>RMS</sub> of which have frequency contents from DC up to the filter's cutoff frequency. The total wideband noise ( $\mu$ V<sub>RMS</sub>) is nearly independent of the value of the clock. The clock feedthrough specifications are not part of the wideband noise.

### Speed Limitations

The LT1164-7 optimizes AC performance vs power consumption. To avoid op amp slew rate limiting at maximum clock frequencies, the signal amplitude should be kept below a specified level as shown in Table 9.

**Table 9. Maximum V<sub>IN</sub> vs V<sub>S</sub> and Clock**

POWER SUPPLY	MAXIMUM f <sub>CLK</sub>	MAXIMUM V <sub>IN</sub>
$\pm$ 7.5V	1MHz	2.0V <sub>RMS</sub> (f <sub>IN</sub> > 20kHz) 0.7V <sub>RMS</sub> (f <sub>IN</sub> > 250kHz)
$\pm$ 5V	1MHz	1.4V <sub>RMS</sub> (f <sub>IN</sub> > 20kHz) 0.5V <sub>RMS</sub> (f <sub>IN</sub> > 100kHz)
Single 5V	1MHz	0.5V <sub>RMS</sub> (f <sub>IN</sub> > 100kHz)

**Table 10. Transient Response of LTC Lowpass Filters**

LOWPASS FILTER	DELAY TIME* (SEC)	RISE TIME** (SEC)	SETTLING TIME*** (SEC)	OVER-SHOOT (%)
LTC1064-3 Bessel	0.50/f <sub>C</sub>	0.34/f <sub>C</sub>	0.80/f <sub>C</sub>	0.5
LTC1164-5 Bessel	0.43/f <sub>C</sub>	0.34/f <sub>C</sub>	0.85/f <sub>C</sub>	0
LTC1164-6 Bessel	0.43/f <sub>C</sub>	0.34/f <sub>C</sub>	1.15/f <sub>C</sub>	1
LTC1264-7 Linear Phase	1.15/f <sub>C</sub>	0.36/f <sub>C</sub>	2.05/f <sub>C</sub>	5
LTC1164-7 Linear Phase	1.20/f <sub>C</sub>	0.39/f <sub>C</sub>	2.20/f <sub>C</sub>	5
LTC1064-7 Linear Phase	1.20/f <sub>C</sub>	0.39/f <sub>C</sub>	2.20/f <sub>C</sub>	5
LTC1164-5 Butterworth	0.80/f <sub>C</sub>	0.48/f <sub>C</sub>	2.40/f <sub>C</sub>	11
LTC1164-6 Elliptic	0.85/f <sub>C</sub>	0.54/f <sub>C</sub>	4.30/f <sub>C</sub>	18
LTC1064-4 Elliptic	0.90/f <sub>C</sub>	0.54/f <sub>C</sub>	4.50/f <sub>C</sub>	20
LTC1064-1 Elliptic	0.85/f <sub>C</sub>	0.54/f <sub>C</sub>	6.50/f <sub>C</sub>	20

\* To 50%  $\pm$ 5%, \*\* 10% to 90%  $\pm$ 5%, \*\*\* To 1%  $\pm$ 0.5%

## APPLICATIONS INFORMATION

### Transient Response

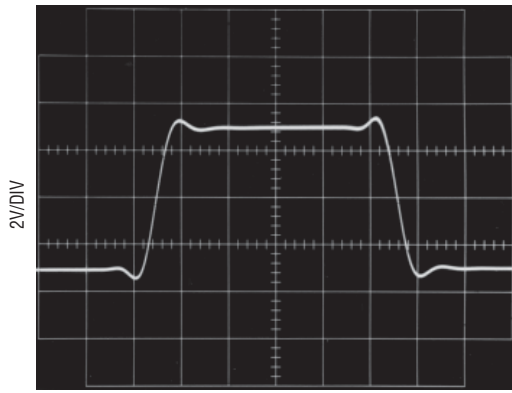

INPUT = 1kHz ±3V  
 $f_{CLK} = 500kHz$   
 $f_c = 10kHz$   
 $V_S = \pm 7.5V$

Figure 5

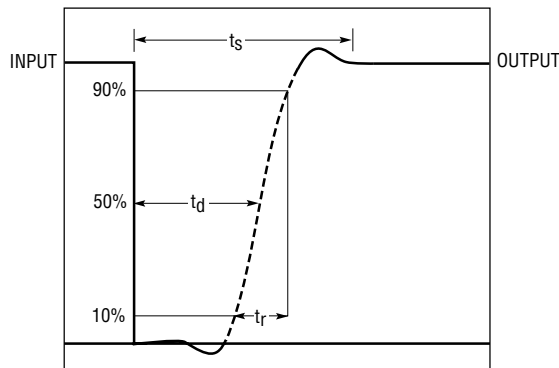

$$\text{RISE TIME } (t_r) = \frac{0.39}{f_{CUTOFF}} \pm 5\%$$

$$\text{SETTLING TIME } (t_s) = \frac{2.2}{f_{CUTOFF}} \pm 5\%$$

(TO 1% OF OUTPUT)

$$\text{TIME DELAY } (t_d) = \text{GROUP DELAY} = \frac{1.2}{f_{CUTOFF}}$$

(TO 50% OF OUTPUT)

1164-7 F06

Figure 6

### Aliasing

Aliasing is an inherent phenomenon of sampled data systems and it occurs when input frequencies close to the sampling frequency are applied. For the LTC1164-7 case at 100:1, an input signal whose frequency is in the range of  $f_{CLK} \pm 3\%$ , will be aliased back into the filter's passband.

If, for instance, an LTC1164-7 operating with a 100kHz clock and 1kHz cutoff frequency receives a 98kHz 10mV input signal, a 2kHz, 143 $\mu V_{RMS}$  alias signal will appear at its output. When the LTC1164-7 operates with a clock-to-cutoff frequency of 50:1, aliasing occurs at twice the clock frequency. Table 11 shows details.

Table 11. Aliasing ( $f_{CLK} = 100kHz$ )

INPUT FREQUENCY ( $V_{IN} = 1V_{RMS}$ , $f_{IN} = f_{CLK} \pm f_{OUT}$ ) (kHz)	OUTPUT LEVEL (Relative to Input, $0dB = 1V_{RMS}$ ) (dB)	OUTPUT FREQUENCY (Aliased Frequency $f_{OUT} = ABS [f_{CLK} \pm f_{IN}]$ ) (kHz)
<b>50:1, <math>f_{CUTOFF} = 2kHz</math></b>		
190 (or 210)	-76.1	10.0
195 (or 205)	-51.9	5.0
196 (or 204)	-36.3	4.0
197 (or 203)	-18.4	3.0
198 (or 202)	-3.0	2.0
199.5 (or 200.5)	-0.2	0.5
<b>100:1, <math>f_{CUTOFF} = 1kHz</math></b>		
97 (or 103)	-74.2	3.0
97.5 (or 102.5)	-53.2	2.5
98 (or 102)	-36.9	2.0
98.5 (or 101.5)	-19.6	1.5
99 (or 101)	-5.2	1.0
99.5 (or 100.5)	-0.7	0.5

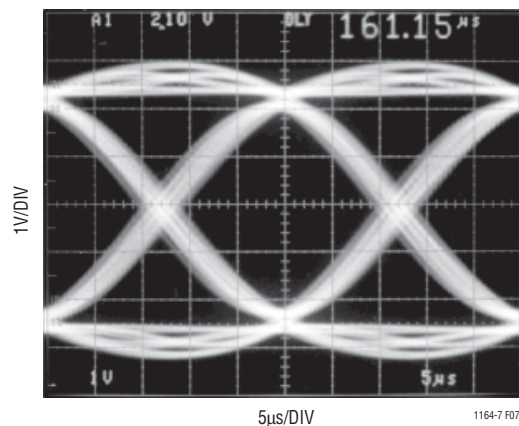

$V_S = \pm 7.5V$   
 $f_{CLK} = 1MHz$   
 $f_c = 20kHz$   
 $(f_{CLK}/f_c) = 50:1$

Figure 7. Eye Diagram

# PACKAGE DESCRIPTION

**J Package**  
**14-Lead CERDIP (Narrow .300 Inch, Hermetic)**  
 (Reference LTC DWG # 05-08-1110)

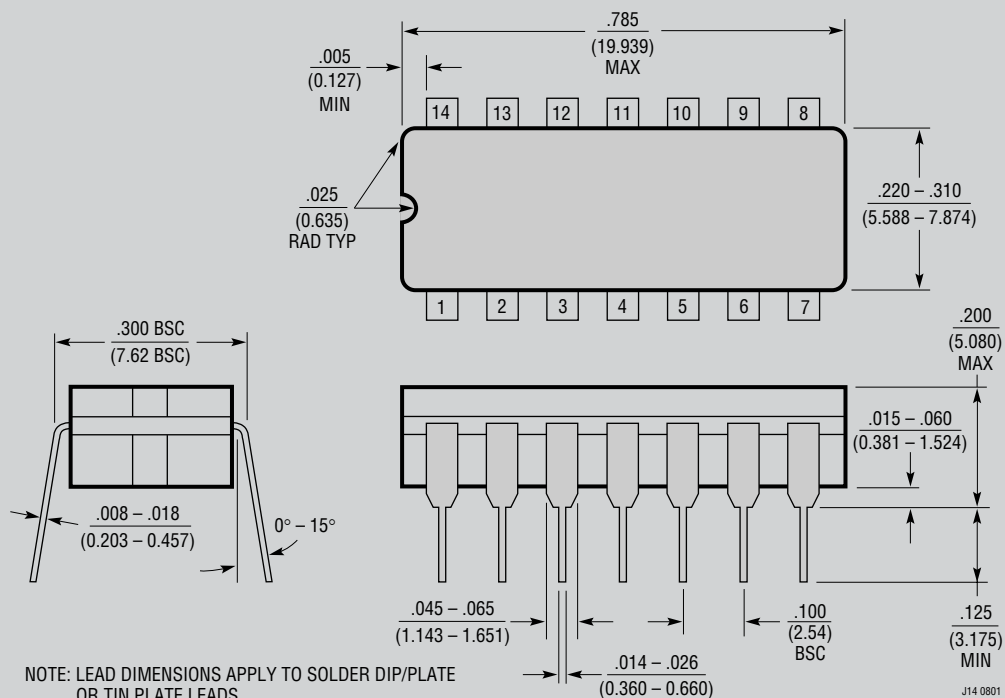

**OBsolete PACKAGE**

# PACKAGE DESCRIPTION

**N Package**  
**14-Lead PDIP (Narrow .300 Inch)**  
 (Reference LTC DWG # 05-08-1510)

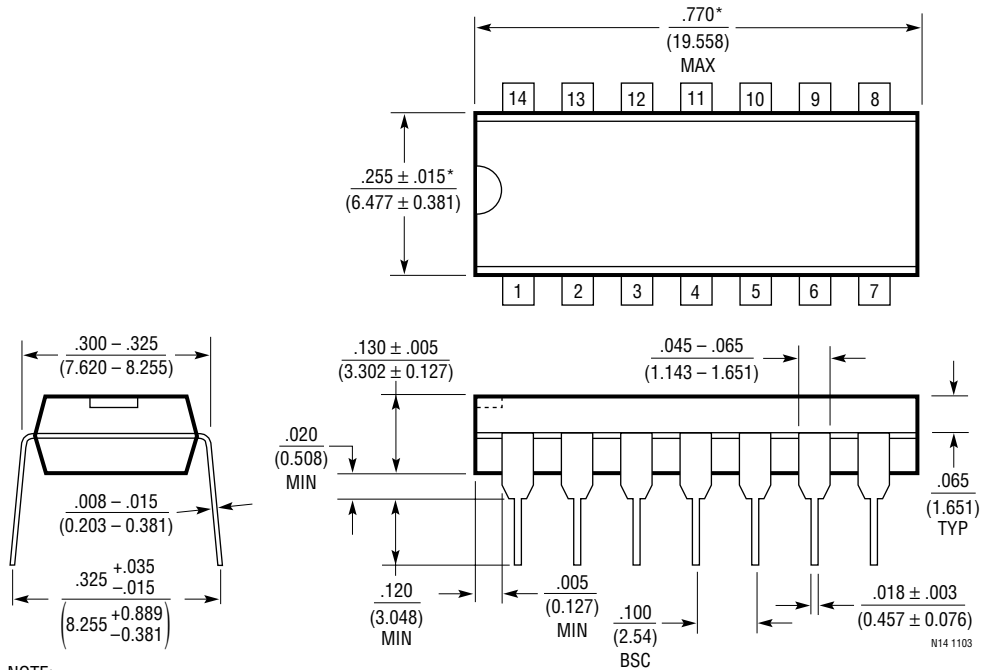

NOTE:  
 1. DIMENSIONS ARE  $\frac{\text{INCHES}}{\text{MILLIMETERS}}$   
 \*THESE DIMENSIONS DO NOT INCLUDE MOLD FLASH OR PROTRUSIONS.  
 MOLD FLASH OR PROTRUSIONS SHALL NOT EXCEED .010 INCH (0.254mm)

N14 1103

# PACKAGE DESCRIPTION

## SW Package 16-Lead Plastic Small Outline (Wide .300 Inch) (Reference LTC DWG # 05-08-1620)

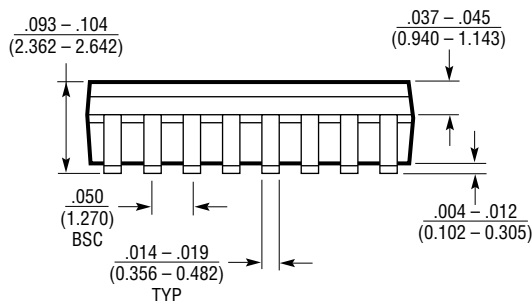
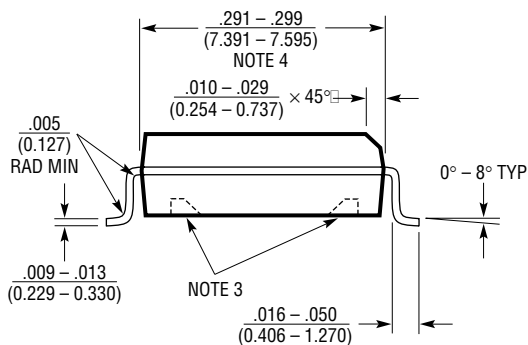
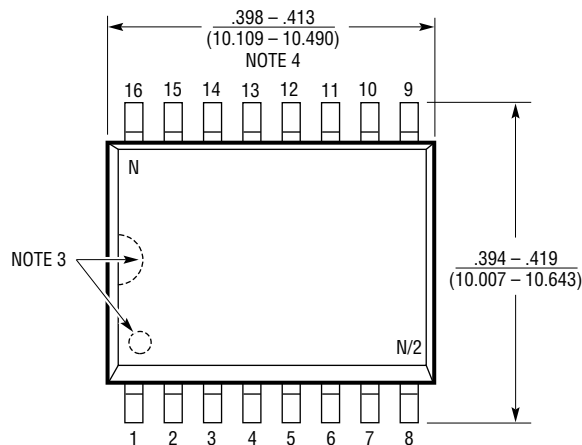
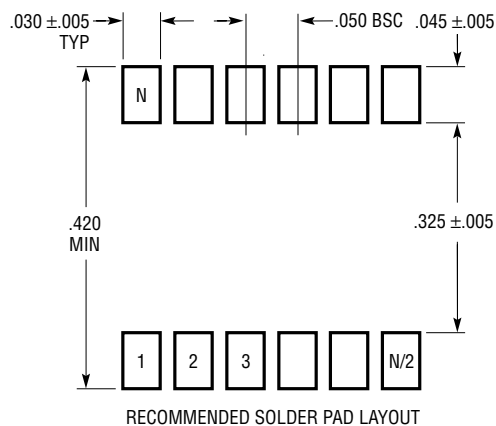

- NOTE:
1. DIMENSIONS IN  $\frac{\text{INCHES}}{\text{MILLIMETERS}}$
  2. DRAWING NOT TO SCALE
  3. PIN 1 IDENT, NOTCH ON TOP AND CAVITIES ON THE BOTTOM OF PACKAGES ARE THE MANUFACTURING OPTIONS. THE PART MAY BE SUPPLIED WITH OR WITHOUT ANY OF THE OPTIONS
  4. THESE DIMENSIONS DO NOT INCLUDE MOLD FLASH OR PROTRUSIONS. MOLD FLASH OR PROTRUSIONS SHALL NOT EXCEED .006" (0.15mm)

S16 (WIDE) 0502

## TYPICAL APPLICATIONS

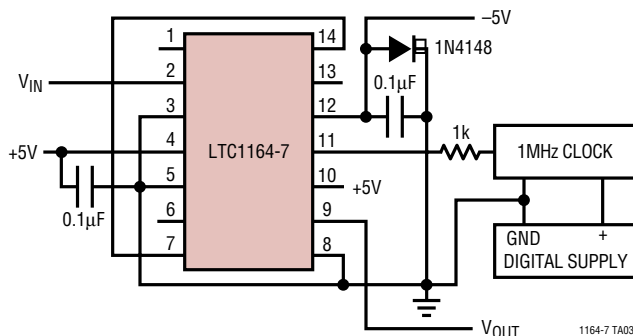

20kHz Linear Phase Lowpass Filter

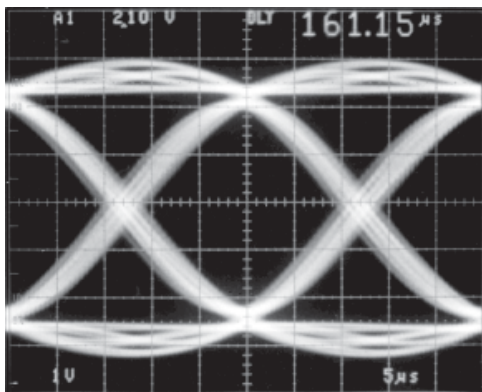

Eye Diagram

## RELATED PARTS

PART NUMBER	DESCRIPTION	COMMENTS
LTC1064	Universal Filter Building Block	Allows for Bandpass (Up to 50kHz) Using Ext Resistors
LTC1064-1/2/3/4/7	8th Order Low Pass Filters, $F_0$ Max = 100kHz	Cauer, Butterworth, Bessel or Improved Bessel
LTC1164	Universal Filter Building Block	Allows for Bandpass (Up to 20kHz) Using Ext Resistors
LTC1164-5/6	8th Order Low Pass Filters, $F_0$ Max = 20kHz	Butterworth, Bessel or Elliptic
LTC1264	Universal Filter Building Block	Allows for Bandpass (Up to 100kHz) Using Ext Resistors
LTC1264-7	8th Order Low Pass Filter, $F_0$ Max = 200kHz	Flat Group Delay, High Speed Lowpass Filter
LT6600-2.5	Low Noise Differential Amp and 10MHz Lowpass	55µV <sub>RMS</sub> Noise 100kHz to 10MHz 3V Supply
LT6600-10	Low Noise Differential Amp and 20MHz Lowpass	86µV <sub>RMS</sub> Noise 100kHz to 20MHz 3V Supply