

CSRS065V0P RoHs Device

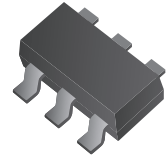

Features

- ESD Protect for 4 high-speed I/O channels.
- IEC61000-4-2 Level 4 ESD protection.
- IEC61000-4-4 (FET)20A for I/O,80A for Power.
- Working voltage: 5V
- Low capacitance:1.3pF(Typ.).
- High component density.

Mechanical data

- Case: SOT-23-6 standard package, molded plastic.
- Terminals: Solder plated, solderable per MIL-STD-750,method 2026.
- Mounting position: Any
- Weight: 0.015 gram (approx.).

Circuit Diagram

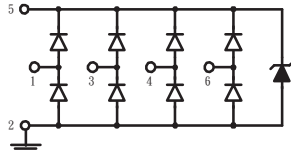

Pin Configuration

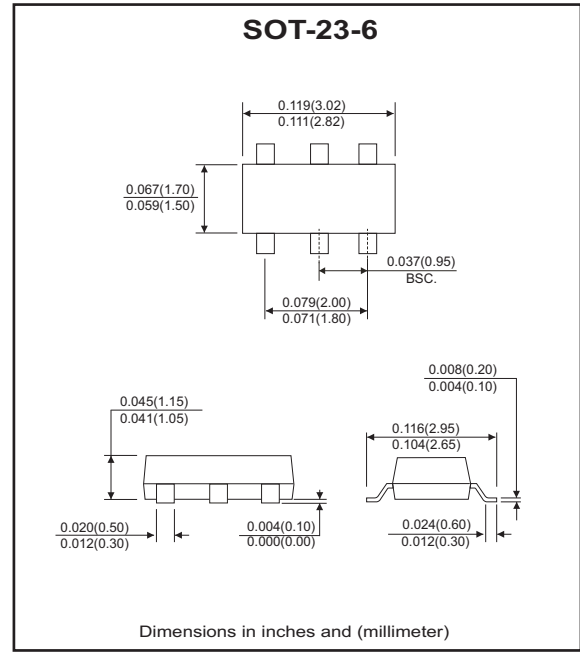
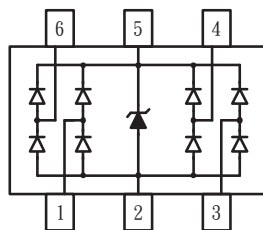

Maximum Ratings (at TA=25°C unless otherwise noted)

Parameter	Symbol	Value	Unit
Peak pulse current (tp = 8/20 us)	I _{PP}	6.5	A
ESD per IEC 61000-4-2(Air) ESD per IEC 61000-4-2(Contact)	ESD	18 14	kV
ESD per IEC 61000-4-2(Air)(VDD-GND) ESD per IEC 61000-4-2(Contact)(VDD-GND)	ESD_VDD	30	kV
Lead soldering temperature	T _{SOL}	260 (10 sec)	°C
Operating temperature	T _J	-55 to +85	°C
Storage temperature	T _{STG}	-55 to +125	°C
DC voltage at any I/O pin	V _{IO}	(GND -0.5) to (VDD +0.5)	V

Electrical Characteristics (at TA=25°C unless otherwise noted)

Parameter	Conditions	Symbol	Min	Typ	Max	Unit
Reverse stand-Off voltage	Pin 5 to Pin 2	V_{RWM}			5	V
Reverse leakage current	$V_{RWM} = 5\text{ V}$, Pin 5 to Pin 2	I_R			5	uA
	$V_{PIN5} = 5\text{ V}$, $V_{PIN2} = 0\text{ V}$, $V_{IO} = 0\sim 5\text{ V}$				1	
Diode breakdown voltage	$I_R = 1\text{ mA}$, Pin 5 to Pin 2	V_{BD}	6		9	V
Forward voltage	$I_F = 15\text{ mA}$, Pin 2 to Pin 5	V_F		0.8	1	V
Clamping voltage	$I_{PP} = 5\text{ A}$, $t_p = 8/20\mu\text{s}$, Any Channel Pin to Ground	V_C		8.1	9	V
	IEC 61000-4-2 +6kV, Contact mode Any Channel Pin to Ground			12.5		
	IEC 61000-4-2 +6kV, Contact mode VDD Pin to Ground			9		
Junction capacitance	$V_{pin5} = 5\text{ V}$, $V_{pin2} = 0\text{ V}$, $V_{IO} = 2.5\text{ V}$, $f = 1\text{ MHz}$, Any Channel Pin to Ground	C_j		1.3	1.6	pF
	$V_{pin5} = 5\text{ V}$, $V_{pin2} = 0\text{ V}$, $V_{IO} = 2.5\text{ V}$, $f = 1\text{ MHz}$, Between Channel Pins			0.12	0.14	
	$V_{pin5} = 5\text{ V}$, $V_{pin2} = 0\text{ V}$, $V_{IN} = 2.5\text{ V}$, $f = 1\text{ MHz}$, Channel_x pin to ground - channel_y pin to ground			0.05	0.07	

RATING AND CHARACTERISTIC CURVES (CSRS065V0P)

Fig. 1 - Power derating curve

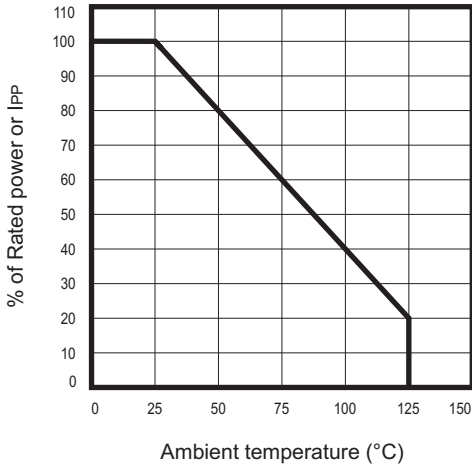

Fig. 2 - Clamping voltage vs. Peak pulse current

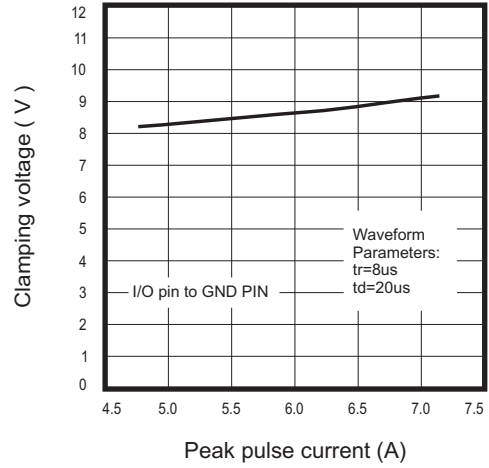

Fig.3 - Forward voltage v.s. forward current

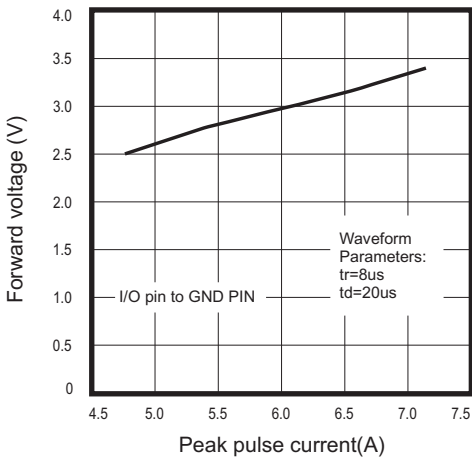

Fig.4 - Typical variation of C_{IN} v.s. V_{IN}

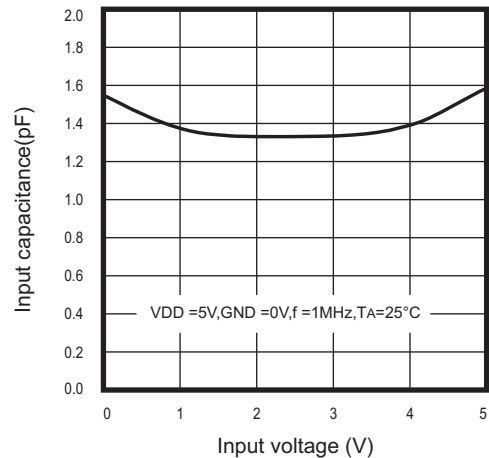

Fig. 5 - Typical variation of C_{IN} v.s. temperature

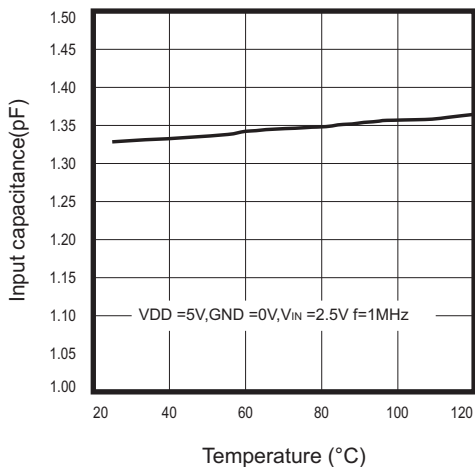

Fig. 6 - Transmission line pulsing (TLP) measurement

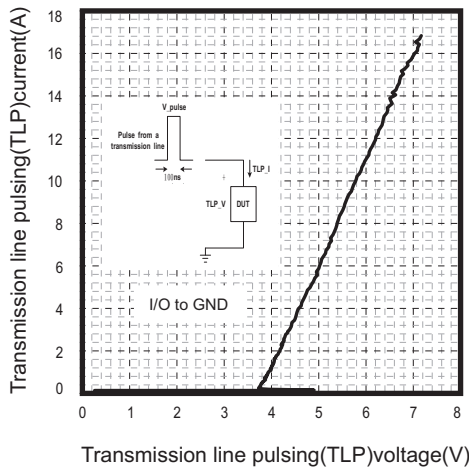
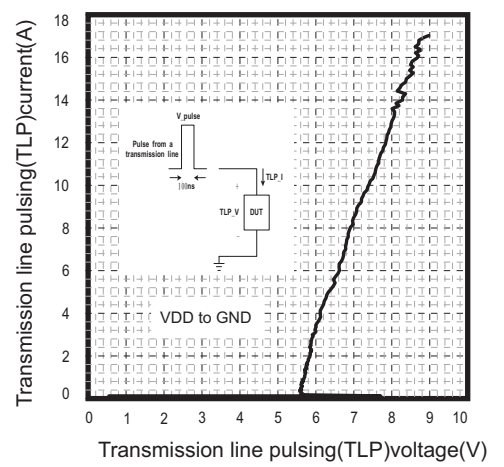
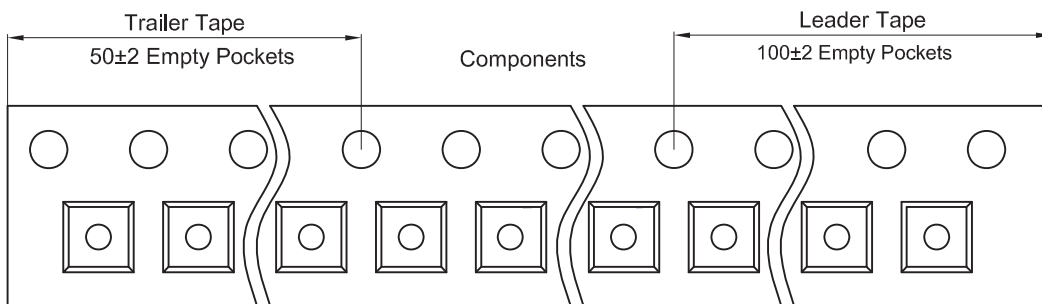
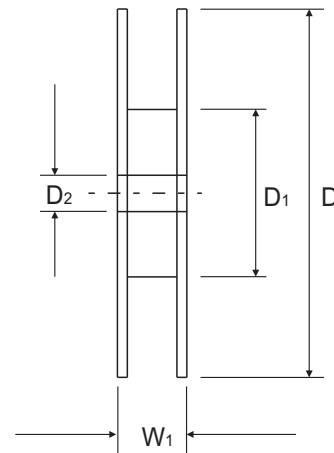
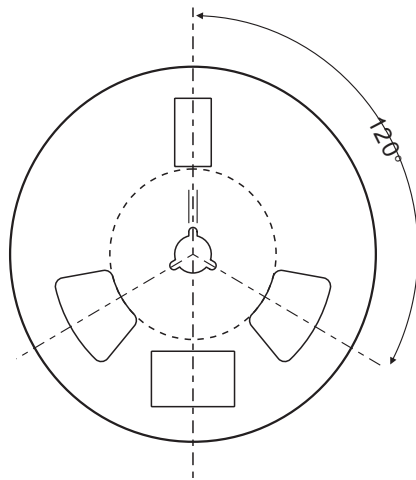
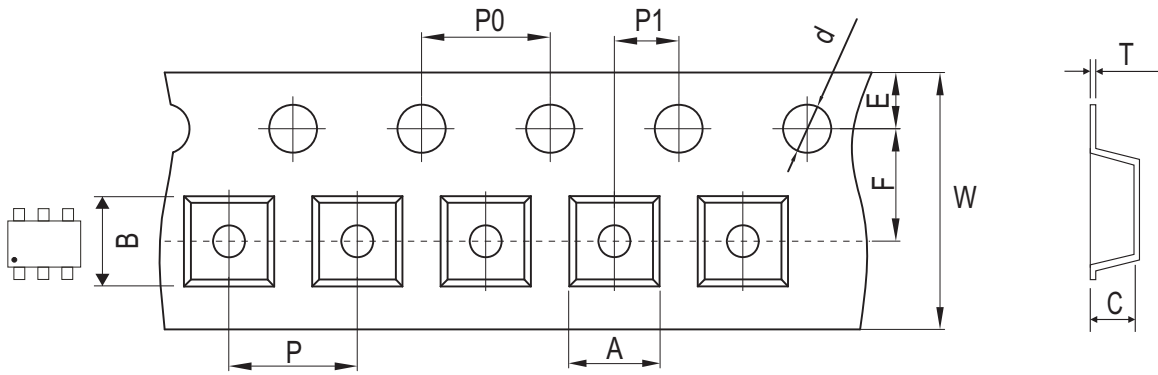

Fig.7 -Transmission line pulsing (TLP) measurement



Reel Taping Specification



SOT-23-6	SYMBOL	A	B	C	d	D	D1	D2
	(mm)	3.17 ± 0.10	3.23 ± 0.10	1.37 ± 0.10	1.50 ± 0.05	180.0 + 0.00 / - 0.30	60.00 ± 0.50	13.00 ± 0.20
	(inch)	0.125 ± 0.004	0.127 ± 0.004	0.054 ± 0.004	0.059 ± 0.002	7.087 + 0.00 / - 0.012	2.362 ± 0.020	0.512 ± 0.008

SOT-23-6	SYMBOL	E	F	P	P0	P1	W	W1
	(mm)	1.75 ± 0.10	3.50 ± 0.05	4.00 ± 0.10	4.00 ± 0.10	2.00 ± 0.05	8.00 + 0.30 / - 0.10	12.30 ± 0.20
	(inch)	0.069 ± 0.004	0.138 ± 0.002	0.157 ± 0.004	0.157 ± 0.004	0.079 ± 0.002	0.315 + 0.012 / - 0.004	0.484 ± 0.008

Marking Code

Part Number	Marking Code
CSRS065V0P	C05

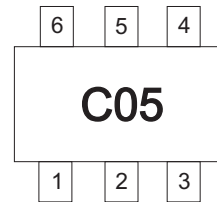

Suggested PAD Layout

SIZE	SOT-23-6	
	(mm)	(inch)
A	1.10	0.043
B	0.60	0.024
C	0.95	0.037
D	2.50	0.098
E	3.60	0.142

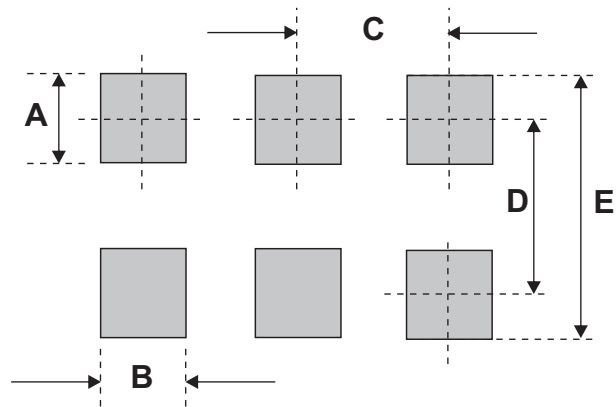

Standard Packaging

Case Type	REEL PACK	
	REEL (pcs)	Reel Size (inch)
SOT-23-6	3,000	7