

PART No. 1485C4P

for more information visit
www.hammfg.com

Data subject to change without notice

Isometric drawing Not to Scale

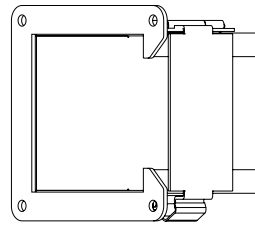

TOP VIEW

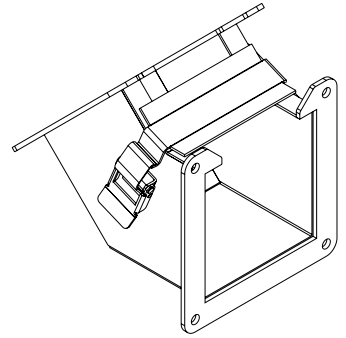

ISOMETRIV VIEW

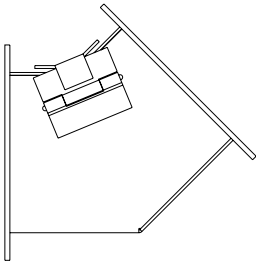

BACK SIDE

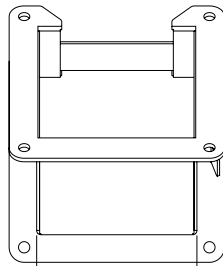

SIDE VIEW

4.00

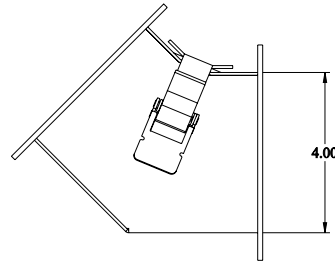

FRONT VIEW

4.00

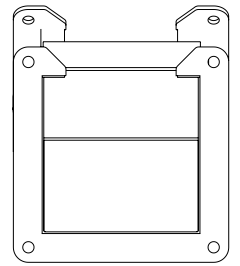

SIDE VIEW

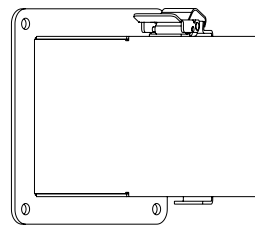

BOTTOM VIEW