

v00.0110

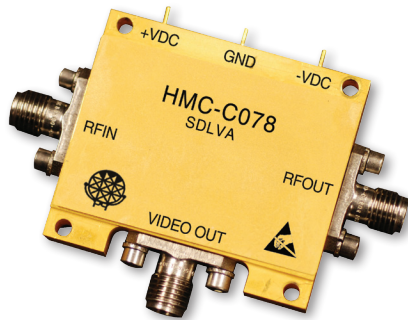

SUCCESSIVE DETECTION LOG VIDEO AMPLIFIER (SDLVA) MODULE w/ LIMITED RF OUTPUT, 2 - 20 GHz



Typical Applications

The HMC-C078 is ideal for:

- EW, ELINT & IFM Receivers
- DF Radar Systems
- ECM Systems
- Broadband Test & Measurement
- Power Measurement & Control Circuits
- Military & Space Applications

Functional Diagram

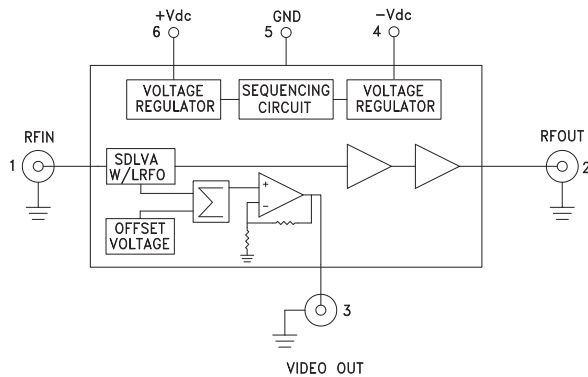

Features

- Limited RF Output Power
- High Logging Range: 50 dB
- Output Frequency Flatness: ± 1 dB
- Internal Voltage Regulation
- Fast Rise/Fall Times: 5/8 ns
- Hermetically Sealed Module
- 55 °C to +85 °C Operating Temperature

General Description

The HMC-C078 is a Successive Detection Log Video Amplifier (SDLVA) which operates from 2 to 20 GHz. The HMC-C078 provides a logging range of 50 dB.

This product comes standard with two female SMA field replaceable connectors but can also be used with blind mate SMP connectors or as a drop-in module. The package size measures 1.5 x 1.32 x 0.23" (38.10 x 33.53 x 5.84 mm) making it ideal for environmentally robust applications where space is limited. In addition to the video output signal, the HMC-C078 has a limited RF output port.

The HMC-C078 has integrated voltage regulators on both the positive and negative supply.

Electrical Specifications, $T_A = +25$ °C +Vdc = +12V, -Vdc = -7V

Parameter	Conditions	Min	Typ.	Max	Units
Input Frequency Range			2 - 20		GHz
Frequency Flatness	Pin= -25 dBm		± 1		dB
Log Linearity	Pin= -40 dBm to +0 dBm		± 1		dBm
Log Linearity over Temperature	-55 to +85° C, Pin= -25 dBm		± 1		dB
Minimum Logging Range	to ± 3 dB error		-45		dBm
Maximum Logging Range	to ± 3 dB error		5		dBm
Input Return Loss			8		dB
Output Return Loss			15		dB
Small Signal Gain		40	44		dB
Saturated Output Power (10 GHz)		5	7	10	dBm
Log Video Minimum Output Voltage		0.1	0.25	0.5	V
Log Video Maximum Output Voltage		2.3	2.5	2.7	V

Information furnished by Analog Devices is believed to be accurate and reliable. However, no responsibility is assumed by Analog Devices for its use, nor for any infringements of patents or other rights of third parties that may result from its use. Specifications subject to change without notice. No license is granted by implication or otherwise under any patent or patent rights of Analog Devices. Trademarks and registered trademarks are the property of their respective owners.

For price, delivery, and to place orders: Analog Devices, Inc., One Technology Way, P.O. Box 9106, Norwood, MA 02062-9106
Phone: 781-329-4700 • Order online at www.analog.com
Application Support: Phone: 1-800-ANALOG-D

HMC-C078* PRODUCT PAGE QUICK LINKS

Last Content Update: 02/23/2017

[COMPARABLE PARTS](#)

View a parametric search of comparable parts.

[DOCUMENTATION](#)

Data Sheet

- [HMC-C078 Data Sheet](#)

[DESIGN RESOURCES](#)

- [HMC-C078 Material Declaration](#)
- [PCN-PDN Information](#)
- [Quality And Reliability](#)
- [Symbols and Footprints](#)

[DISCUSSIONS](#)

View all HMC-C078 EngineerZone Discussions.

[SAMPLE AND BUY](#)

Visit the product page to see pricing options.

[TECHNICAL SUPPORT](#)

Submit a technical question or find your regional support number.

[DOCUMENT FEEDBACK](#)

Submit feedback for this data sheet.



**SUCCESSIVE DETECTION LOG VIDEO AMPLIFIER (SDLVA)
MODULE w/ LIMITED RF OUTPUT, 2 - 20 GHz**

Electrical Specifications, (continued)

Parameter	Conditions	Min	Typ.	Max	Units
Tangential Signal Sensitivity (TSS)	2 - 20 GHz, 20 MHz VBW		-54		dBm
Log Video Output Rise Time	Pin = -20 dBm, 10% to 90%		5		ns
Log Video Output Fall Time	Pin = -20 dBm, 90% to 10%		8		ns
Log Video Recovery Time	-40 dBm to 0 dBm		25		ns
Log Video Output Slope	Pin = 35 dBm	37	42	47	mV/dB
Log Video Output Slope Variation over Temperature	@ 10 GHz		10		$\mu\text{V/dB}^\circ\text{C}$
Log Video Propagation Delay			20		ns
+Vdc Voltage Range		9	12	15	V
-Vdc Voltage Range		-6	-7	-15	V
Supply Current (+Idc)			370	400	mA
Supply Current (-Idc)			20		mA

Error Flatness vs. Input Power Over Frequency

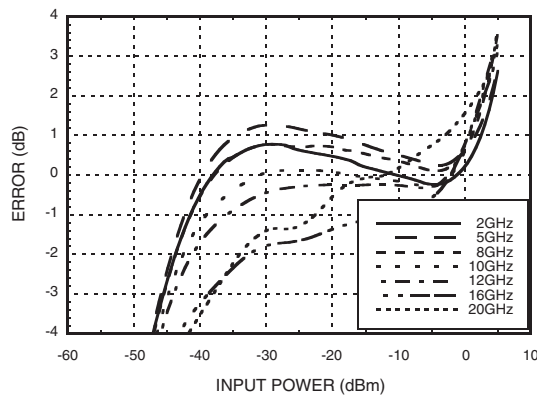

X-Band Error Flatness vs. Input Power Over Frequency

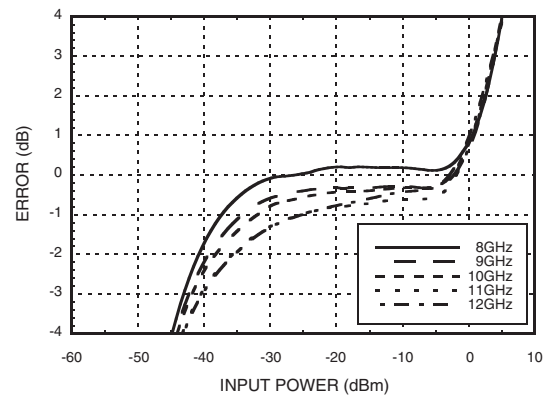

VIDEO OUT & Error vs. Input Power, Fin = 2 GHz

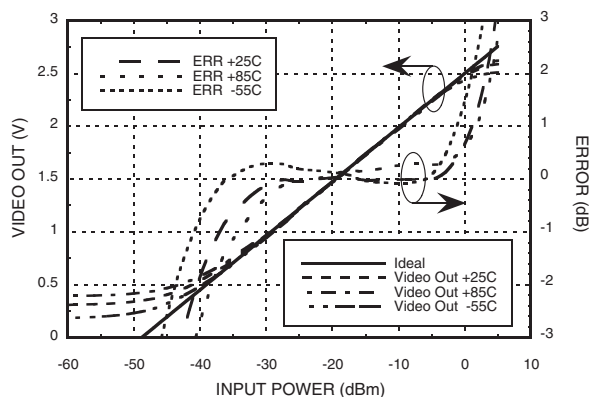

VIDEO OUT & Error vs. Input Power, Fin = 5 GHz

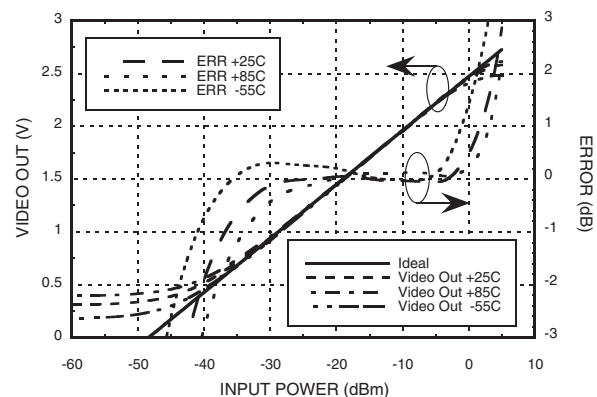

Information furnished by Analog Devices is believed to be accurate and reliable. However, no responsibility is assumed by Analog Devices for its use, nor for any infringements of patents or other rights of third parties that may result from its use. Specifications subject to change without notice. No license is granted by implication or otherwise under any patent or patent rights of Analog Devices. Trademarks and registered trademarks are the property of their respective owners.

For price, delivery, and to place orders: Analog Devices, Inc., One Technology Way, P.O. Box 9106, Norwood, MA 02062-9106 Phone: 781-329-4700 • Order online at www.analog.com Application Support: Phone: 1-800-ANALOG-D



**SUCCESSIVE DETECTION LOG VIDEO AMPLIFIER (SDLVA)
MODULE w/ LIMITED RF OUTPUT, 2 - 20 GHz**

VIDEO OUT & Error vs. Input Power, $F_{in} = 8$ GHz

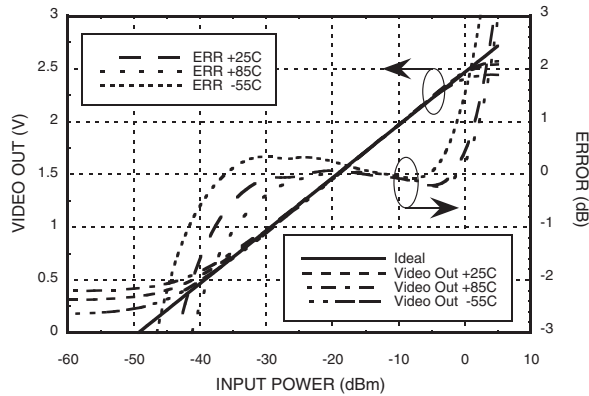

VIDEO OUT & Error vs. Input Power, $F_{in} = 10$ GHz

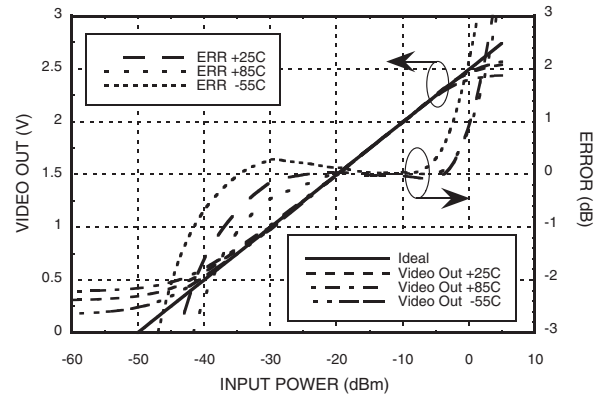

VIDEO OUT vs. Error vs. Input Power, $F_{in} = 12$ GHz

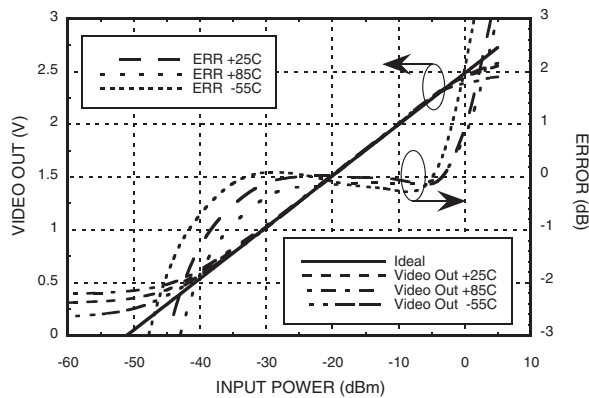

VIDEO OUT & Error vs. Input Power, $F_{in} = 16$ GHz

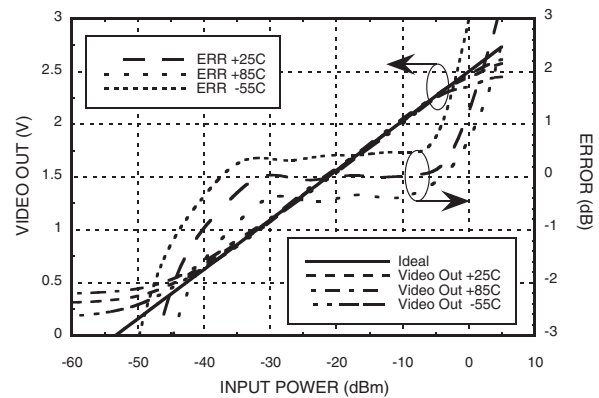

VIDEO OUT & Error vs. Input Power, $F_{in} = 20$ GHz

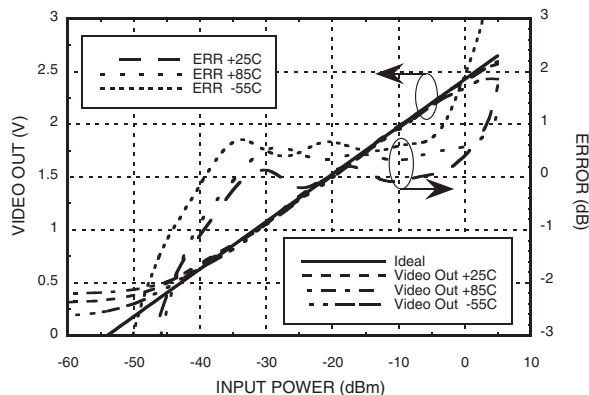

VIDEO OUT vs. Frequency Over Input Power & Temperature

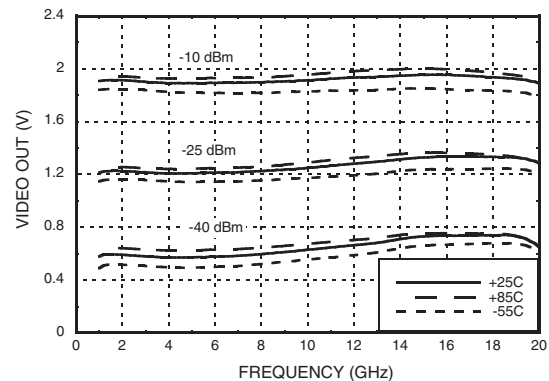

Information furnished by Analog Devices is believed to be accurate and reliable. However, no responsibility is assumed by Analog Devices for its use, nor for any infringements of patents or other rights of third parties that may result from its use. Specifications subject to change without notice. No license is granted by implication or otherwise under any patent or patent rights of Analog Devices. Trademarks and registered trademarks are the property of their respective owners.

For price, delivery, and to place orders: Analog Devices, Inc., One Technology Way, P.O. Box 9106, Norwood, MA 02062-9106 Phone: 781-329-4700 • Order online at www.analog.com Application Support: Phone: 1-800-ANALOG-D



**SUCCESSIVE DETECTION LOG VIDEO AMPLIFIER (SDLVA)
MODULE w/ LIMITED RF OUTPUT, 2 - 20 GHz**

**Output Power vs. Frequency
Over Input Power & Temperature**

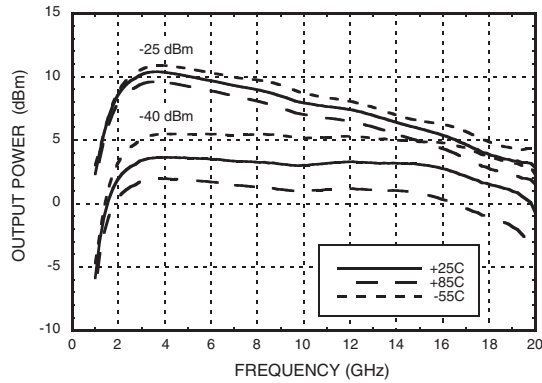

Output Power vs. Input Power

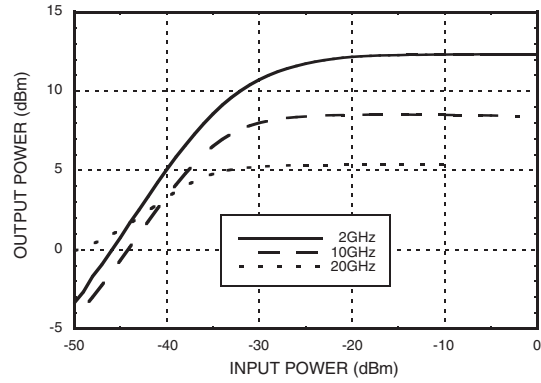

Return Loss vs. Frequency

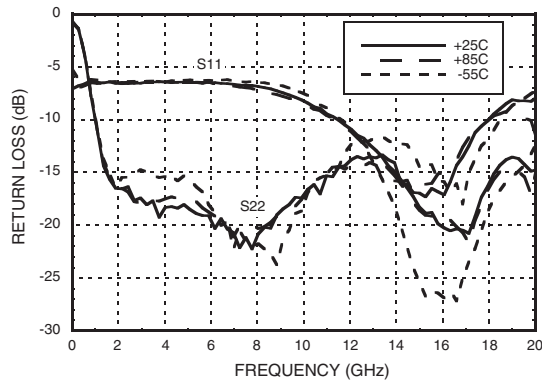

Rise Time @ 10 GHz @ -20 dBm

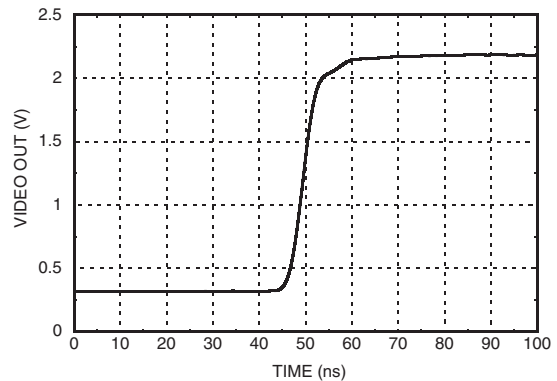

Fall Time @ 10 GHz @ -20 dBm

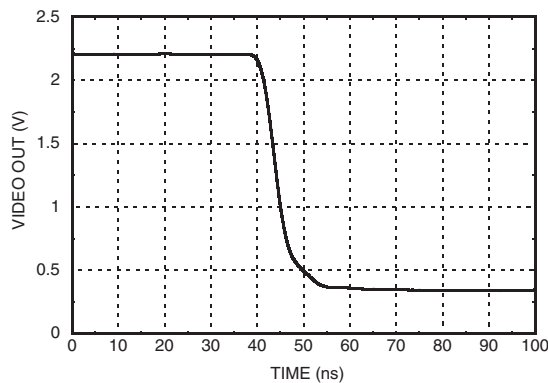

Absolute Maximum Ratings

RF Input Power	+10 dBm
Junction Temperature	125 °C
Continuous P _{diss} (T=85°C)	6.3 W
+V _{dc}	+15V
-V _{dc}	-15V
Storage Temperature	-65 to +150 °C
Operating Temperature	-55 to +85 °C
ESD Sensitivity (HBM)	Class 0
HMC-C078 is a Class 0 ESD sensitive part. RF input and RF output pass 50V ESD HBM exposure.	



**ELECTROSTATIC SENSITIVE DEVICE
OBSERVE HANDLING PRECAUTIONS**

Information furnished by Analog Devices is believed to be accurate and reliable. However, no responsibility is assumed by Analog Devices for its use, nor for any infringements of patents or other rights of third parties that may result from its use. Specifications subject to change without notice. No license is granted by implication or otherwise under any patent or patent rights of Analog Devices. Trademarks and registered trademarks are the property of their respective owners.

For price, delivery, and to place orders: Analog Devices, Inc., One Technology Way, P.O. Box 9106, Norwood, MA 02062-9106 Phone: 781-329-4700 • Order online at www.analog.com Application Support: Phone: 1-800-ANALOG-D



**SUCCESSIVE DETECTION LOG VIDEO AMPLIFIER (SDLVA)
MODULE w/ LIMITED RF OUTPUT, 2 - 20 GHz**

Outline Drawing

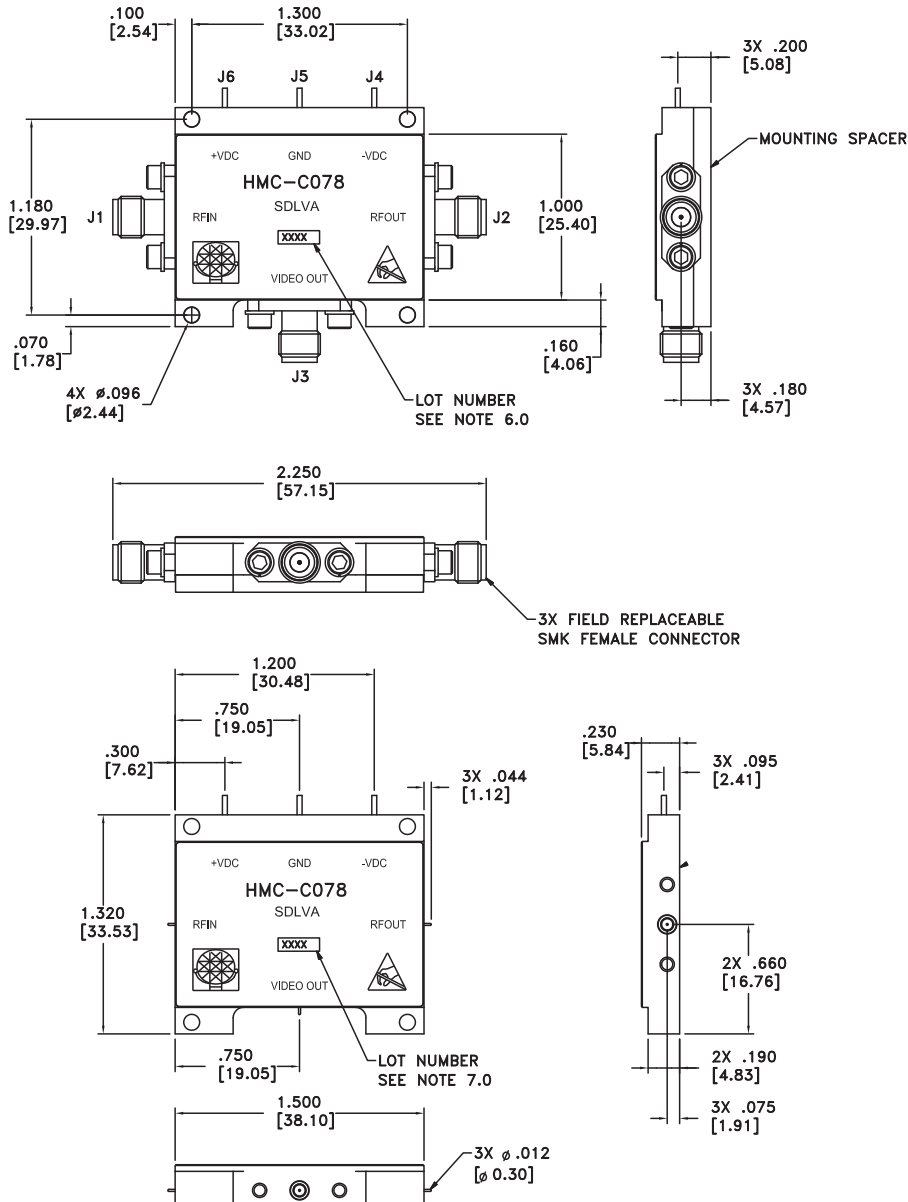

VIEW SHOWN WITH CONNECTORS REMOVED

Package Information

Package Type	C-21
Package Weight [1]	39.5 gms
Spacer Weight	8.5 gms

[1] Includes the connectors

[2] ±1 gms Tolerance

NOTES:

- 1.0 PACKAGE, LEADS COVER MATERIAL: KOVAR
- 2.0 FINISH: GOLD PLATE OVER NICKEL PLATE.
- 3.0 MOUNTING SPACER: NICKEL PLATED ALUMINUM.
- 4.0 ALL DIMENSIONS ARE IN INCHES [MILLIMETERS].
- 5.0 TOLERANCES:
- 5.1 .XX = ±.02 [0.5 mm]
- 5.1 .XXX = ±.010 [0.25 mm]
- 6.0 MARK LOT NUMBER ON .080 X .250 LABEL APPROXIMATELY WHERE SHOWN, WITH .030 MINIMUM TEXT HEIGHT.
- 7.0 USE MOUNTING SPACER PART NUMBER 125177.



SUCCESSIVE DETECTION LOG VIDEO AMPLIFIER (SDLVA) MODULE w/ LIMITED RF OUTPUT, 2 - 20 GHz

Pin Descriptions

Pin Number	Function	Description	Interface Schematic
1	RFIN	RF Input pin.	
2	RFOUT	This pin is AC coupled and matched to 50 Ohms	
3	VIDEO OUT	Video Out is a voltage that is proportional to the log of the Input Power. (50 Ohm optimal load)	
4, 6	-Vdc, +Vdc	Bias Supply.	
5	GND	This pin must be connected to a high quality RF/DC ground.	