

TABLE OF CONTENTS	
SHEET NO.	SHEET DESCRIPTION
1	NOTES AND BOM
2	CONFIGURATIONS
3-4	KEY CONFIGURATIONS
5	RECEPTACLE CONNECTOR ASSEMBLY
6	BACKSHELL NOTES
7	BACKSHELL
8	BACKSHELL CONFIGURATIONS
9	2X10 CONNECTOR INTERFACE DEFINITION

NOTES: VALID UNLESS OTHERWISE SPECIFIED

1. GENERAL:

a. APPLICATION SPECIFICATION SEE: AS-33472-100  
 -CONTAINS: PRODUCT INTRODUCTION, PRODUCT SUMMARY, CONNECTOR ASSEMBLY, PACKAGING INFORMATION, CONNECTOR MATING, SERVICE INSTRUCTIONS, ELECTRICAL CONTINUITY CHECKING, CRIMPING, AND TROUBLESHOOTING.  
 -DESIGNED TO MATE WITH DEVICE OR CONNECTOR AS SPECIFIED IN THE MATING INTERFACE/CONNECTOR DRAWINGS CHART.  
 \*DENOTES DRAWINGS THAT CAN BE ACCESSED AT <http://ewcap.uscarteams.org/>.  
 -ASSEMBLY SHIPPED WITH PLR IN PRE-LOCK POSITION (SEE PLR PRE-LOCK VIEW SHEET 5).

b. PRODUCT SPECIFICATION SEE:  
 -STANDARD CONFIGURATION (STD): PS-33472-000  
 -TRANSMISSION CONFIGURATION (TRNS):  
 CONTAINS SILICONE: TS-160038-0001  
 SILICONE FREE: TBD  
 -UL V0 CONFIGURATION (UL V0): TBD  
 CONTAINS: PRODUCT INTRODUCTION, PRODUCT SUMMARY, RATINGS (CURRENT, TEMPERATURE, SEALING, AND FLAMMABILITY), TERMINALS, WIRE DIAMETER RANGE, PRODUCT VALIDATION, AND PRODUCT DEVIATIONS.

c. PACKAGING SPECIFICATION PER MOLEX DRAWING; SEE PACKAGING CHART

d. PARTS MUST BE IN COMPLIANCE TO MOLEX CHEMICAL SUBSTANCES FOR PRODUCTS AND PACKAGING SPECIFICATION: OEH5-699000-301

e. DATA MUST BE SUBMITTED UNDER THE MOLEX PART NUMBER TO IMDS (COMPANY ID=13255)

2. DESIGN - MATERIALS:

a. FOR BILL OF MATERIALS SEE:  
 -STANDARD CONFIGURATION SD-33472-0002  
 -TRANSMISSION CONFIGURATION  
 CONTAINS SILICONE: SD-160038-0002  
 SILICONE FREE: SD-160092-0002  
 -UL V0 CONFIGURATION SD-160074-0002

b. TRANSMISSION CONNECTOR COMPONENTS MUST MEET THE MATERIAL REQUIREMENTS SPECIFIED IN TS-160038-0001 & TBD

3. DESIGN - GEOMETRY:

a. THE 3-D CAD DATA IS BASIC (WITHOUT TOLERANCE) AND MASTER FOR THIS PART WITH THE EXCEPTION OF UNDERLINED DIMENSIONS, DIMENSIONAL INFORMATION NOT SHOWN ON THIS DRAWING IS DEFINED BY THE DATA FILE AT ITS LATEST REVISION.

b. GEOMETRIC DIMENSIONS AND TOLERANCES PER ASME Y14.5M-2009

c. EDGES AND UNDIMENSIONED DETAILS PER ISO13715

d. CORNERS SHOWN AS SHARP TO BE R 0.2 MAX.

e. LETTERING SHALL BE 0.15 MAX RAISED IN 0.25 MAX RECESS PAD. THIS INCLUDES RECYCLING CODE, CAVITY ID, VENDOR IDENTIFICATION, AND CUSTOMER MATERIAL NUMBER.

f. VISUAL DEFECTS SHALL MEET COSMETIC STANDARD PS-45499-002 (Class B).

g. LASER MARKING:  
 1. PART NUMBER  
 2. DAY OF THE YEAR  
 3. SHIFT  
 4. YEAR

FOR ADDITIONAL INFORMATION SEE SECTION 5 UNDER PROCEDURES IN ES-34735-008.

h. 2X2 CLIP-SLOT DESIGN IS BASED ON USCAR/EWCAP 7mm CLIP SLOT EWCAP - 005 - 7  
 2X3 THRU 2X10 CLIP-SLOT DESIGN IS BASED ON USCAR/EWCAP 11mm CLIP SLOT EWCAP - 005 - 11

PACKAGING	
DESCRIPTION	DRAWING NO.
2X2	PK-31300-635
2X3	PK-31300-903
2X4	PK-31300-903
2X6	PK-31300-903
2X8	PK-31300-903
2X10	PK-31300-903

MATING INTERFACE/CONNECTOR DRAWINGS		
DESCRIPTION	INTERFACE DEFINITION	MOLEX INLINE
STANDARD 2X2	*150-S-004-2-Z02	SD-33482-0001
UL V0 2X2	*150-S-004-2-Z02	SD-33482-0001
STANDARD 2X3	*150-S-006-2-Z02	SD-33482-0001
TRANSMISSION 2X3	*150-S-006-2-Z02	N/A
STANDARD 2X4	*150-S-008-2-Z02	SD-33482-0001
UL V0 2X4	*150-S-008-2-Z02	SD-33482-0001
STANDARD 2X6	*150-S-012-2-Z01	SD-33482-0001
STANDARD 2X8	*150-S-016-2-Z01	SD-33482-0001
STANDARD 2X10	SD-33472-0001	SD-33482-0001
UL V0 2X10	SD-33472-0001	SD-33482-0001

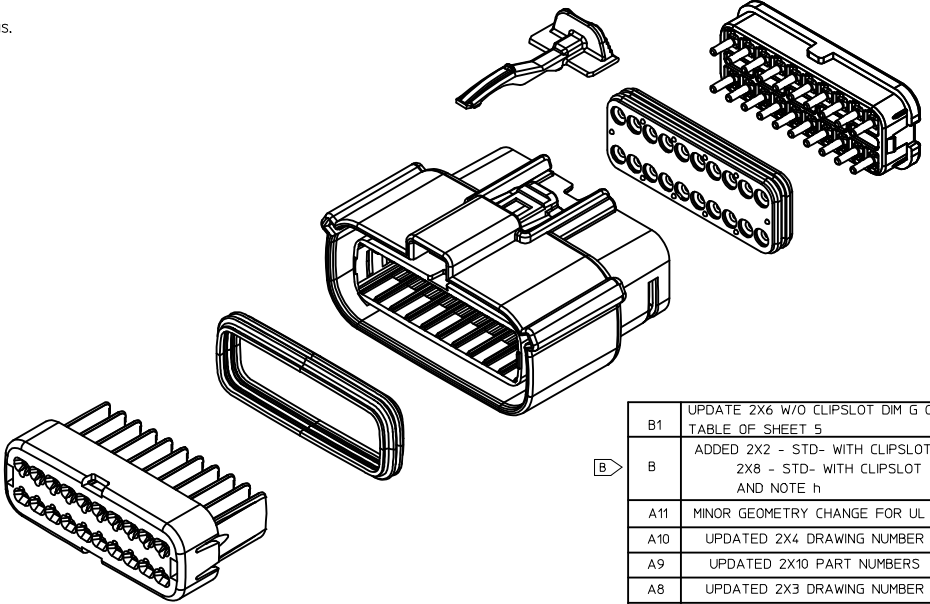
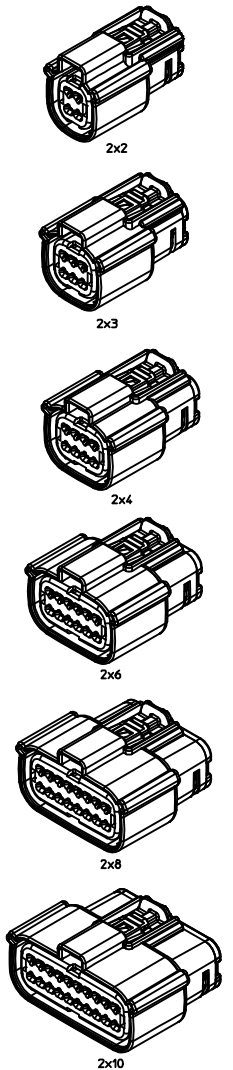

B1	UPDATE 2X6 W/O CLIPSLOT DIM G ON TABLE OF SHEET 5
B	ADDED 2X2 - STD- WITH CLIPSLOT, 2X8 - STD- WITH CLIPSLOT AND NOTE h
A11	MINOR GEOMETRY CHANGE FOR UL V0
A10	UPDATED 2X4 DRAWING NUMBER
A9	UPDATED 2X10 PART NUMBERS
A8	UPDATED 2X3 DRAWING NUMBER
A7	UPDATED 2X10 INTERFACE
A6	ADDED TRANSMISSION REFERENCES
A5	ADD 2X10 INTERFACE SHEETS
A4	ADD UL V0 CONFIGURATIONS
A3	ADDED 2X3 STD AND TRANSMISSION
A2	UPDATED 2X8 BLD DRAWINGS
A1	FIXED TYPO IN NOTE 1a, UPDATED 2X6 MOLEX INLINE BLADE DRAWING
A	INITIAL RELEASE
REV	REV DESCRIPTION

INSPECTION NUMBER LOG  
 LAST NUMBER: 11  
 ADDED: 11  
 REMOVED:

ENTER DESCRIPTION EC NO: UAUZ017-0214 DRWING: 104 CHKD: APPR: KDKOSKI REV: B1	DIMENSION STYLE <b>MM ONLY</b>	SCALE <b>1.5:1</b>	DESIGN UNITS METRIC	THIRD ANGLE PROJECTION	
	QUALITY SYMBOLS ∇=0 ∇=0 ∇=0	GENERAL TOLERANCES (UNLESS SPECIFIED) 4 PLACES ± --- ± --- 3 PLACES ± --- ± --- 2 PLACES ± 0.10 ± --- 1 PLACE ± 0.2 ± --- 0 PLACE ± --- ± ---	DRAWN BY DATE APROFFITT 2014/05/14 CHECKED BY DATE	TITLE <b>MX150 RCPT DUAL ROW SEALED ASSEMBLY MAT SEAL</b>	
	DRAFT WHERE APPLICABLE MUST REMAIN WITHIN DIMENSIONS	APPROVED BY DATE VKOSHY 2014/06/27	DOCUMENT NO. <b>SD-33472-0001</b>		
	MATERIAL NO. SEE NOTE 2a.	SIZE 1	SHEET NO. 1 OF 9		

THIS DRAWING CONTAINS INFORMATION THAT IS PROPRIETARY TO MOLEX INCORPORATED AND SHOULD NOT BE USED WITHOUT WRITTEN PERMISSION

**SHEET DESCRIPTION**  
CONFIGURATIONS

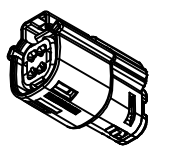

2X2 - STD.  
2X2 - TRNS. - SILICONE FREE †

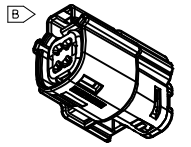

2X2 - STD. - WITH CLIPSLOT \*

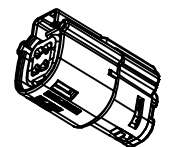

† 2X2 - UL V0

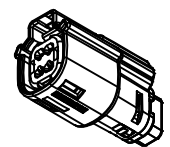

2X2 - STD. - LENGTHENED

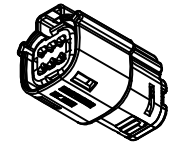

2X3 - STD.  
2X3 - TRNS. - CONTAINS SILICONE †

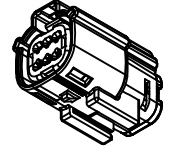

2X3 - STD. - WITH CLIPSLOT \*

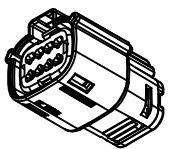

2X4 - STD.

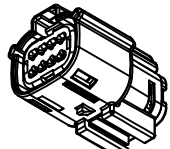

2X4 - STD. - WITH CLIPSLOT \*

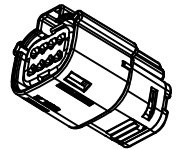

† 2X4 - UL V0

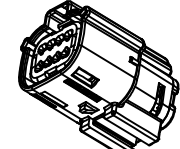

† 2X4 - UL V0-WITH CLIPSLOT\*

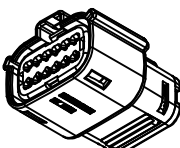

2X6 - STD.

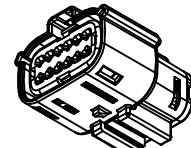

2X6 - STD. - WITH CLIPSLOT \*

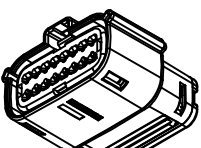

2X8 - STD.

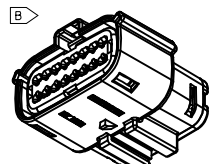

2X8 - STD. - WITH CLIPSLOT \*

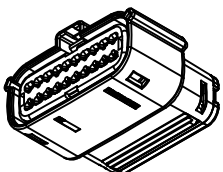

2X10 - STD.

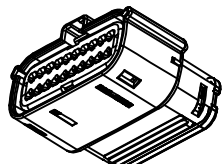

† 2X10 - UL V0

\* WITH CLIPSLOT CONFIGURATION DOES NOT MEET THE USCAR PACKAGING FRAME REQUIREMENTS  
† MINOR GEOMETRY DIFFERENCE THAN STANDARD CONFIGURATION. SEE NOTES 1a & 2a-b FOR MORE INFORMATION

<b>ENTER DESCRIPTION</b> EC NO: UAU2017-0214 DRAWING: 104 CHKD: APPR: KDKOSK1 2016/09/09 2016/09/14 B1	QUALITY SYMBOLS ∇=0 ∇=1 ∇=2	GENERAL TOLERANCES (UNLESS SPECIFIED) 4 PLACES ± --- ± --- 3 PLACES ± --- ± --- 2 PLACES ± 0.10 ± --- 1 PLACE ± 0.2 ± --- 0 PLACE ± --- ± --- ANGULAR ± 1 ° DRAFT WHERE APPLICABLE MUST REMAIN WITHIN DIMENSIONS	DIMENSION STYLE <b>MM ONLY</b> DRAWN BY DATE APPROFFITT 2014/05/14 CHECKED BY DATE APPROVED BY DATE VKOSHY 2014/06/27 MATERIAL NO. <b>SEE NOTE 2a.</b>	SCALE <b>1.5:1</b> DESIGN UNITS <b>METRIC</b> THIRD ANGLE PROJECTION	TITLE <b>MX150 RCPT                  DUAL ROW SEALED ASSEMBLY                  MAT SEAL</b> <b>molex</b> DOCUMENT NO. <b>SD-33472-0001</b>	SHEET NO. 2 OF 9
	THIS DRAWING CONTAINS INFORMATION THAT IS PROPRIETARY TO MOLEX INCORPORATED AND SHOULD NOT BE USED WITHOUT WRITTEN PERMISSION					
	SEE NOTE 2a.					
	SEE NOTE 2a.					

**SHEET DESCRIPTION**

KEY CONFIGURATIONS

**2X2**

**2X3**

**2X4**

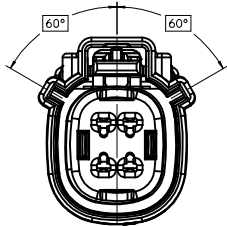

KEY A

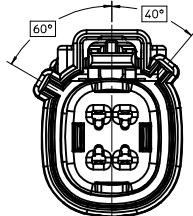

KEY B

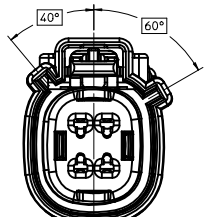

KEY C

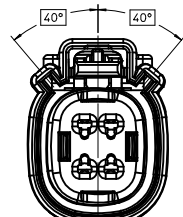

KEY D

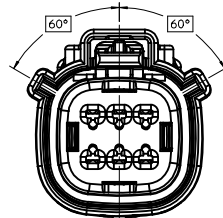

KEY A

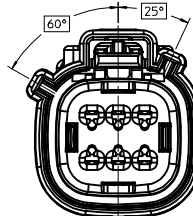

KEY B

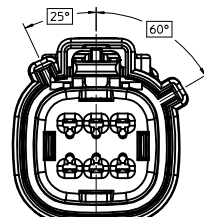

KEY C

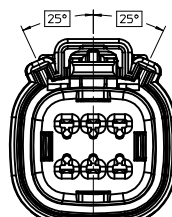

KEY D

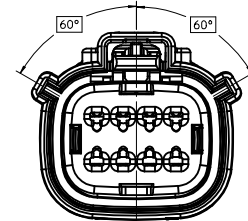

KEY A

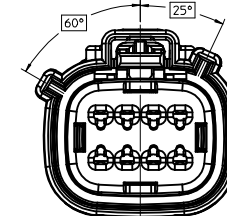

KEY B

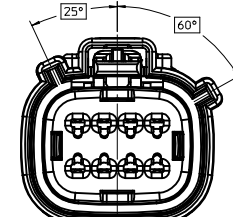

KEY C

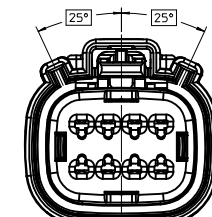

KEY D

<b>ENTER DESCRIPTION</b> EC NO: UAU2017-0214 DRAWING: 104 CHKD: APPR: KCEKOSKI 2016/09/09 2016/09/14 DESCRIPTION	QUALITY SYMBOLS	GENERAL TOLERANCES (UNLESS SPECIFIED)	DIMENSION STYLE	SCALE	DESIGN UNITS	THIRD ANGLE PROJECTION
	∇=0 ∇=0 ∇=0	mm    INCH 4 PLACES ± --- ± --- 3 PLACES ± --- ± --- 2 PLACES ± 0.10 ± --- 1 PLACE ± 0.2 ± --- 0 PLACE ± --- ± --- ANGULAR ± 1 °	DRAWN BY DATE APPROFITT 2014/05/14 CHECKED BY DATE APPROVED BY DATE VKOSHY 2014/06/27	MM ONLY 3:1	METRIC	MX150 RCPT DUAL ROW SEALED ASSEMBLY MAT SEAL <b>molex</b>
DRAFT WHERE APPLICABLE MUST REMAIN WITHIN DIMENSIONS	SEE NOTE 2a.	MATERIAL NO. SD-33472-0001	THIS DRAWING CONTAINS INFORMATION THAT IS PROPRIETARY TO MOLEX INCORPORATED AND SHOULD NOT BE USED WITHOUT WRITTEN PERMISSION			

**SHEET DESCRIPTION**

KEY CONFIGURATIONS CONT.

**2X6**

**2X8**

**2X10**

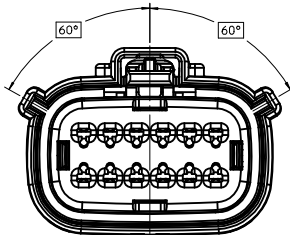

KEY A

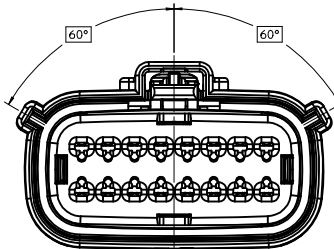

KEY A

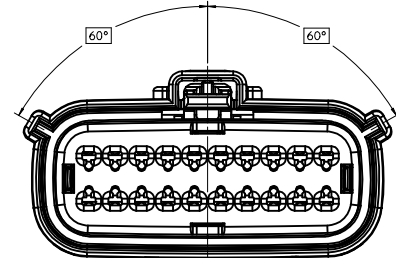

KEY A

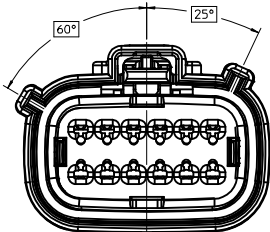

KEY B

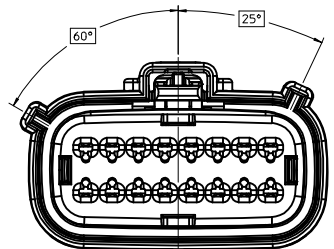

KEY B

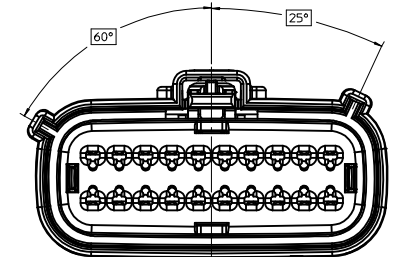

KEY B

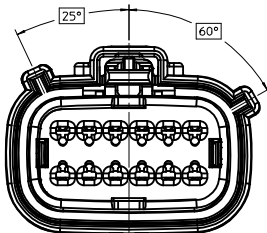

KEY C

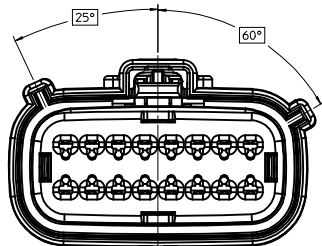

KEY C

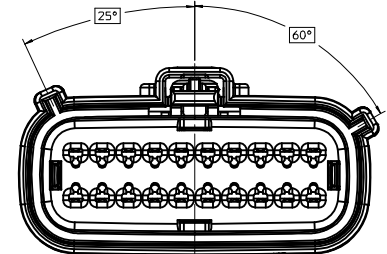

KEY C

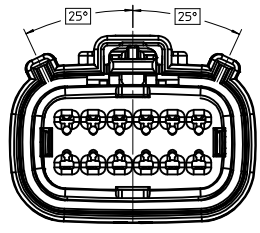

KEY D

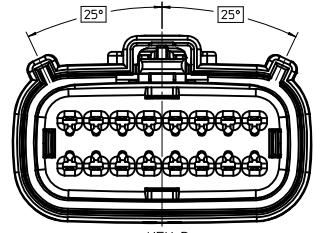

KEY D

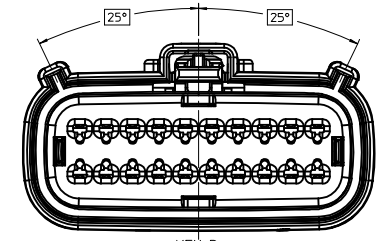

KEY D

<b>ENTER DESCRIPTION</b> EC NO: UAU2017-0214 DRAWING: 104 CHKD: APPR:KDEKOSKI 2016/09/14 2016/09/14	QUALITY SYMBOLS	GENERAL TOLERANCES (UNLESS SPECIFIED)		DIMENSION STYLE	SCALE	DESIGN UNITS	THIRD ANGLE PROJECTION
	▽=0	mm	INCH	MM ONLY	3:1	METRIC	
	▽=0	4 PLACES ± --- ± ---		DRAWN BY DATE			
	▽=0	3 PLACES ± --- ± ---		APPROFIT 2014/05/14			
		2 PLACES ± 0.10 ± ---		CHECKED BY DATE			
		1 PLACE ± 0.2 ± ---		APPROVED BY DATE			
		0 PLACE ± --- ± ---		VKOSHY 2014/06/27			
		ANGULAR ± 1 °		MATERIAL NO.			
		DRAFT WHERE APPLICABLE MUST REMAIN WITHIN DIMENSIONS		SEE NOTE 2a.			
				DOCUMENT NO. SD-33472-0001			
				THIS DRAWING CONTAINS INFORMATION THAT IS PROPRIETARY TO MOLEX INCORPORATED AND SHOULD NOT BE USED WITHOUT WRITTEN PERMISSION			

MX150 RCPT  
DUAL ROW SEALED ASSEMBLY  
MAT SEAL

**molex**

SHEET NO. 4 OF 9

**SHEET DESCRIPTION**  
RECEPTACLE CONNECTOR ASSEMBLY

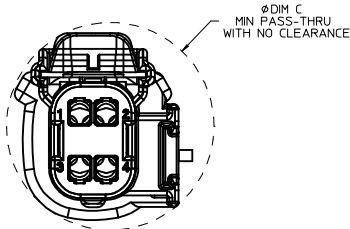
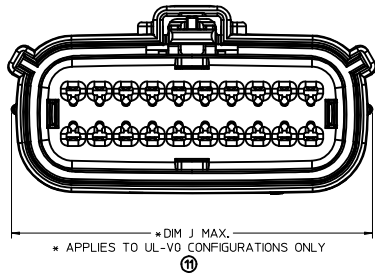

DESCRIPTION	DIMENSIONS							
	A	B	C	D	E	F	G	J
2X2 W/O CLIPSLOT	18.58	1.75	25.45	24.81	37.65	N/A	2.75±0.50	
2X2 W/ LIPSLOT	18.58	1.75	27.65	24.81	37.65	N/A	2.75±0.50	
2X2 LENGTHENED	18.58	1.75	25.45	24.81	42.25	N/A	2.75±0.50	20.04
2X3 W/ CLIPSLOT	22.25	3.50	30.50	N/A	37.65	27.96	4.0±0.4	
2X3 W/O CLIPSLOT	22.25	3.50	26.24	24.90	37.65	N/A	4.0±0.4	
2X4 W/ CLIPSLOT	25.75	1.75	31.50	N/A	37.65	28.00	2.75±0.50	27.04
2X4 W/O CLIPSLOT	25.75	1.75	29.19	24.81	37.65	N/A	2.75±0.50	27.04
2X6 W/ CLIPSLOT	32.75	1.75	35.58	N/A	37.65	27.76	2.75±0.50	
2X6 W/O CLIPSLOT	32.75	1.75	35.58	24.90	37.65	N/A	2.75±0.4	
2X8 W/O CLIPSLOT	39.80	1.75	42.25	24.90	37.65	N/A	4.0±0.4	
2X8 W/ CLIPSLOT	39.80	1.75	42.25	24.90	37.65	27.8	4.0±0.4	
2X10 W/O CLIPSLOT	46.75	1.75	49.05	24.90	37.65	N/A	2.75±0.50	48.04

◁ B ▷ APPLIES TO 2X2 - STD. - WITH CLIPSLOT ONLY

LASER MARKING ON THIS SURFACE  
SEE NOTE 3g.

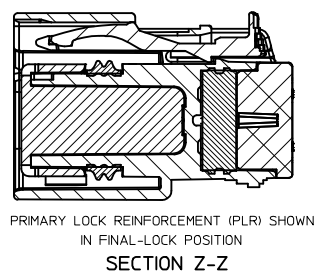
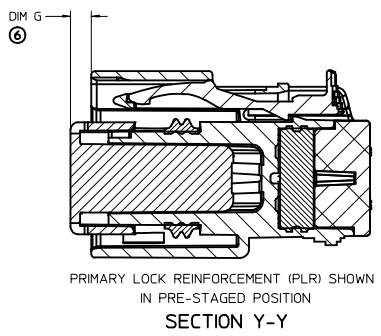
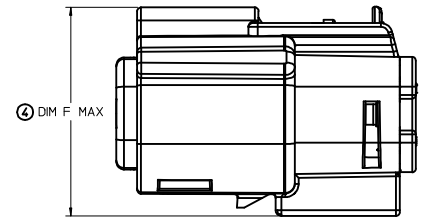
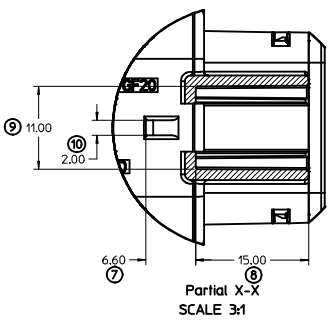
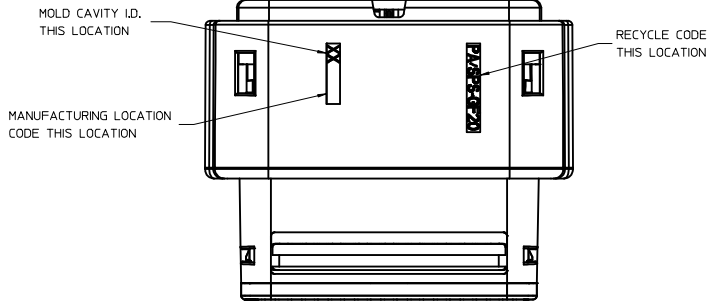
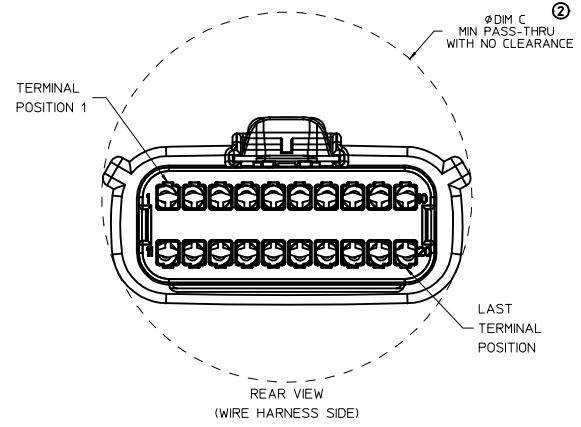
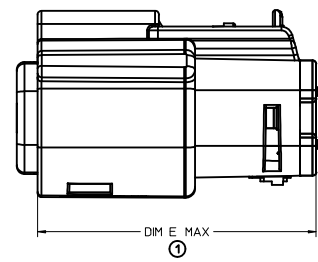
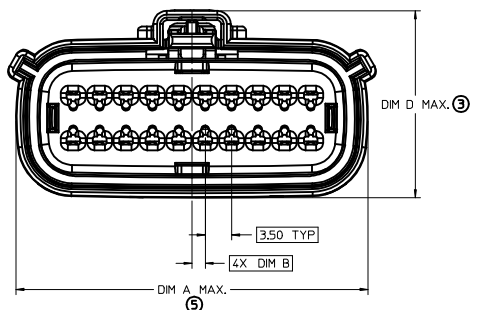
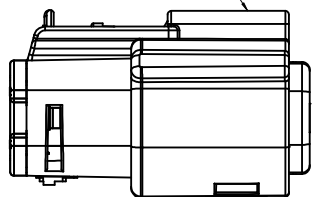

<b>ENTER DESCRIPTION</b> EC NO: UAU2017-0214 DRAWING NO: 2016/09/09 CHKD: DRWINGL104 APPR: KEKOSKI 2016/09/14	<b>QUALITY SYMBOLS</b> ∇=0 ∇=1 ∇=2 ∇=3	<b>GENERAL TOLERANCES (UNLESS SPECIFIED)</b>		DIMENSION STYLE <b>MM ONLY</b>	SCALE <b>3:1</b>	DESIGN UNITS <b>METRIC</b>	THIRD ANGLE PROJECTION
		4 PLACES ± --- ± --- 3 PLACES ± --- ± --- 2 PLACES ± 0.10 ± --- 1 PLACE ± 0.2 ± --- 0 PLACE ± --- ± ---	m/m INCH	DRAWN BY APROFF/ITT DATE 2014/05/14	TITLE <b>MX150 RCPT DUAL ROW SEALED ASSEMBLY MAT SEAL</b>		
		DRAFT WHERE APPLICABLE MUST REMAIN WITHIN DIMENSIONS		APPROVED BY VKOSHY DATE 2014/06/27	MATERIAL NO. <b>SEE NOTE 2a.</b>	DOCUMENT NO. <b>SD-33472-0001</b>	SHEET NO. 5 OF 9
		THIS DRAWING CONTAINS INFORMATION THAT IS PROPRIETARY TO MOLEX INCORPORATED AND SHOULD NOT BE USED WITHOUT WRITTEN PERMISSION					

**SHEET DESCRIPTION**  
BACKSHELL NOTES

BACKSHELL NOTES: VALID UNLESS OTHERWISE SPECIFIED

1. GENERAL:  
 a. APPLICATION SPECIFICATION SEE: AS-34951-001  
 -DESIGNED TO MATE WITH RECEPTACLE SEALED ASSEMBLY SPECIFIED IN MOLEX DRAWING SD-33472-0001.  
 -SYSTEM TO BE USED WITH WIRE WITHIN DIAMETER RANGE OF 1.2mm TO 2.69mm.  
 -COMPONENTS ARE OPTIONAL AND MUST BE PURCHASED SEPERATELY.  
 -BACKSHELL DESIGN IS OWNED BY SCHLEMMER.  
 -FOR ADDITIONAL INFORMATION SEE THE BACKSHELL COMPONENT DRAWING SD-34951-0001.

BACKSHELL CUSTOMER MODEL NUMBER LEGEND

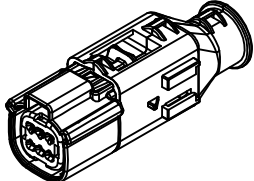
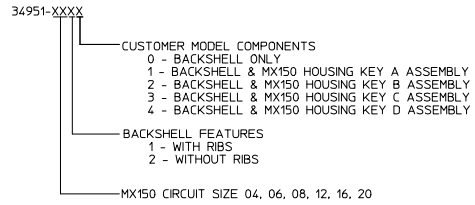

2X3

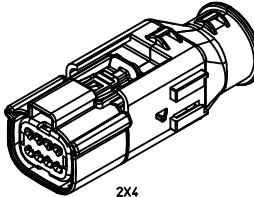

2X4

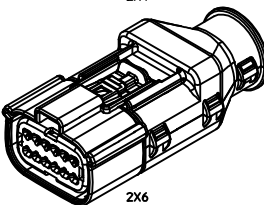

2X6

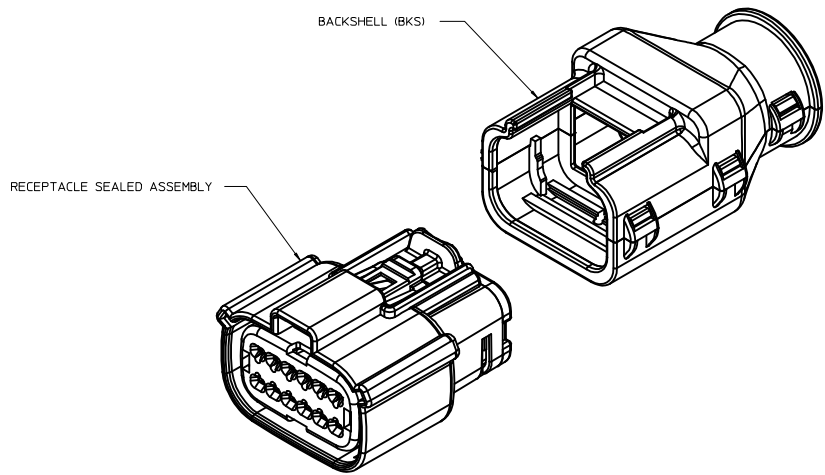

ENTER DESCRIPTION ELEC NO: 0402017-0214 DRAWING: 104 CHKD: APPR: KDK/KOSKI B1	2016/09/09 2016/09/14	QUALITY SYMBOLS	GENERAL TOLERANCES (UNLESS SPECIFIED)		DIMENSION STYLE <b>MM ONLY</b>		SCALE 4:1	DESIGN UNITS METRIC	THIRD ANGLE PROJECTION
	▽=0	4 PLACES ± --- ± ---	mm	INCH	DRAWN BY	DATE	TITLE		
	▽=0	3 PLACES ± --- ± ---			APPROFIT	2014/05/14	MX150 RCPT		
	▽=0	2 PLACES ± 0.10 ± ---			CHECKED BY	DATE	DUAL ROW SEALED ASSEMBLY		
▽=0	1 PLACE ± 0.2 ± ---			APPROVED BY	DATE	MAT SEAL			
▽=0	0 PLACE ± --- ± ---			VKOSHY	2014/06/27	<b>molex</b>			
DRAFT WHERE APPLICABLE MUST REMAIN WITHIN DIMENSIONS		ANGULAR ± 1 °		SEE NOTE 2a.		DOCUMENT NO.		SHEET NO.	
						SD-33472-0001		6 OF 9	
THIS DRAWING CONTAINS INFORMATION THAT IS PROPRIETARY TO MOLEX INCORPORATED AND SHOULD NOT BE USED WITHOUT WRITTEN PERMISSION									

**SHEET DESCRIPTION**

BACKSHELL

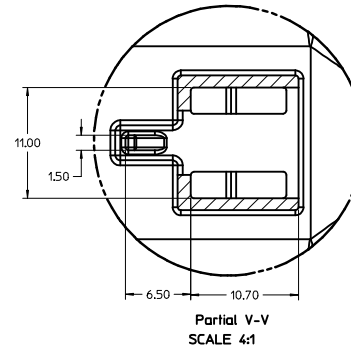
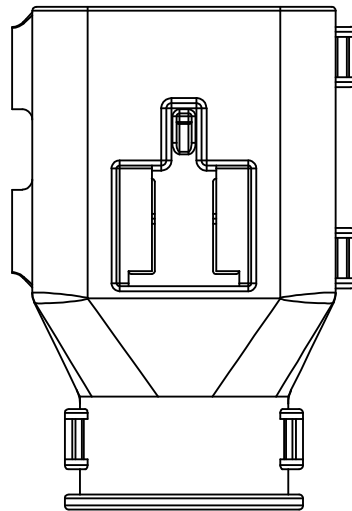
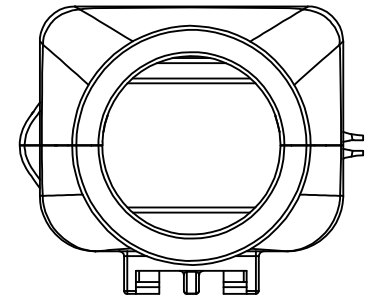
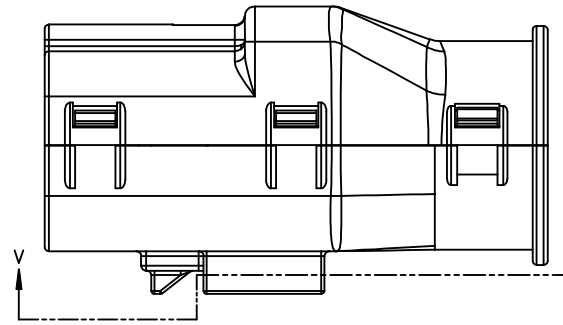
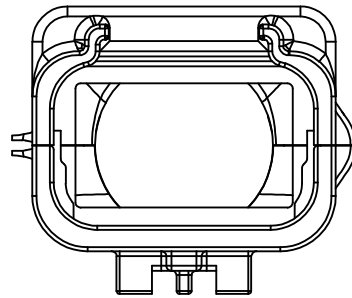
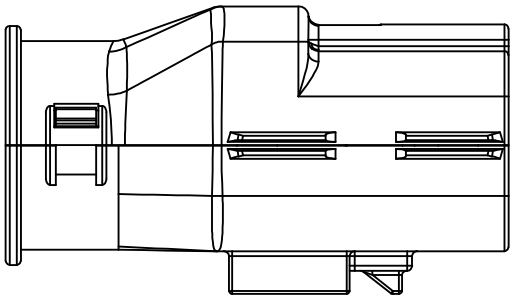

<b>ENTER DESCRIPTION</b> EC NO: UA02017-0214 DRAWING: 104 CHKD: APPR: KDK/OSK1 2016/09/14	QUALITY SYMBOLS ▽=0 ▽=1 ▽=2 ▽=3	GENERAL TOLERANCES (UNLESS SPECIFIED) mm INCH 4 PLACES ± --- ± --- 3 PLACES ± --- ± --- 2 PLACES ± 0.10 ± --- 1 PLACE ± 0.2 ± --- 0 PLACE ± --- ± --- ANGULAR ± 1° DRAFT WHERE APPLICABLE MUST REMAIN WITHIN DIMENSIONS	DIMENSION STYLE <b>MM ONLY</b> DRAWN BY DATE APPROFFITT 2014/05/14 CHECKED BY DATE APPROVED BY DATE VKOSHY 2014/06/27 MATERIAL NO. <b>SEE NOTE 2a.</b>	SCALE <b>4:1</b> DESIGN UNITS <b>METRIC</b> THIRD ANGLE PROJECTION	TITLE <b>MX150 RCPT                  DUAL ROW SEALED ASSEMBLY                  MAT SEAL</b> <b>molex</b> DOCUMENT NO. <b>SD-33472-0001</b>	SHEET NO. <b>7 OF 9</b>
	REV <b>B1</b>	DESCRIPTION	THIS DRAWING CONTAINS INFORMATION THAT IS PROPRIETARY TO MOLEX INCORPORATED AND SHOULD NOT BE USED WITHOUT WRITTEN PERMISSION	SIZE <b>A1</b>	SHEET NO.	SHEET NO.
	REV	DESCRIPTION	THIS DRAWING CONTAINS INFORMATION THAT IS PROPRIETARY TO MOLEX INCORPORATED AND SHOULD NOT BE USED WITHOUT WRITTEN PERMISSION	SIZE	SHEET NO.	SHEET NO.
	REV	DESCRIPTION	THIS DRAWING CONTAINS INFORMATION THAT IS PROPRIETARY TO MOLEX INCORPORATED AND SHOULD NOT BE USED WITHOUT WRITTEN PERMISSION	SIZE	SHEET NO.	SHEET NO.

**SHEET DESCRIPTION**  
BACKSHELL CONFIGURATIONS

CHARTED DIMENSIONS	
DESCRIPTION	DIMENSIONS
	H
2X2 W/O CLIPSLOT	TBD
B 2X2 W/ CLIPSLOT	TBD
2X2 LENGTHENED	TBD
2X3 W/ CLIPSLOT	TBD
2X3 W/O CLIPSLOT	28,50
2X4 W/ CLIPSLOT	TBD
2X4 W/O CLIPSLOT	30,75
2X6 W/ CLIPSLOT	TBD
2X6 W/O CLIPSLOT	35,83
B 2X8 W/O CLIPSLOT	TBD
2X8 W/ CLIPSLOT	TBD
2X10 W/O CLIPSLOT	TBD

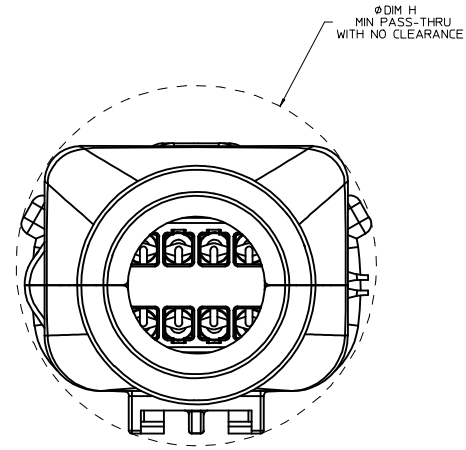
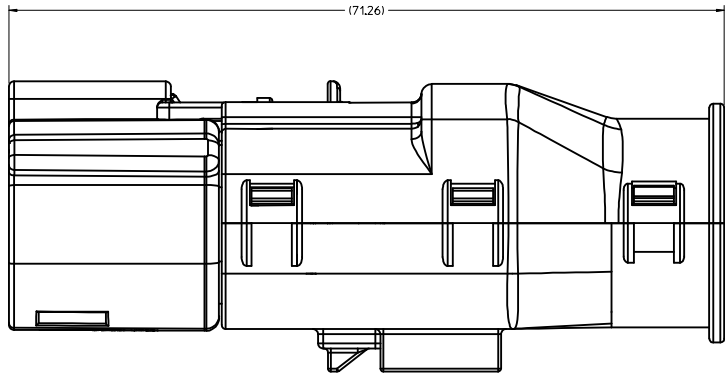

RECEPTACLE SEALED ASSEMBLY WITH RECEPTACLE BACKSHELL

<b>ENTER DESCRIPTION</b> EC NO: UAU2017-0214 DRAWING: 104 CHKD: APPR:KDE/KSK 2016/09/14 2016/09/14	QUALITY SYMBOLS	GENERAL TOLERANCES (UNLESS SPECIFIED)	DIMENSION STYLE	SCALE	DESIGN UNITS	THIRD ANGLE PROJECTION
	▽=0	mm INCH	MM ONLY	4:1	METRIC	
	▽=0	4 PLACES ± --- ± ---	DRAWN BY DATE	TITLE		
	▽=0	3 PLACES ± --- ± ---	APPROFIT 2014/05/14	MX150 RCPT DUAL ROW SEALED ASSEMBLY MAT SEAL		
▽=0	2 PLACES ± 0.10 ± ---	CHECKED BY DATE	DOCUMENT NO.			
▽=0	1 PLACE ± 0.2 ± ---	APPROVED BY DATE	SD-33472-0001			
▽=0	0 PLACE ± --- ± ---	VKOSHY 2014/06/27	SHEET NO.			
	ANGULAR ± 1 °	MATERIAL NO.	8 OF 9			
	DRAFT WHERE APPLICABLE MUST REMAIN WITHIN DIMENSIONS	SEE NOTE 2a.	THIS DRAWING CONTAINS INFORMATION THAT IS PROPRIETARY TO MOLEX INCORPORATED AND SHOULD NOT BE USED WITHOUT WRITTEN PERMISSION			



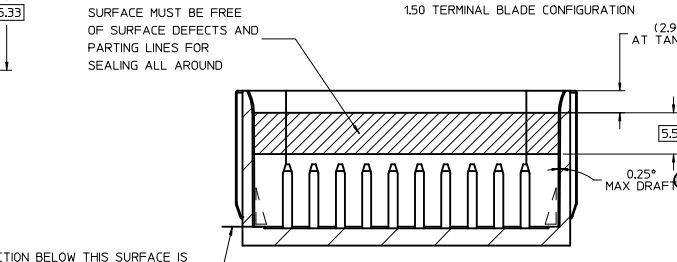
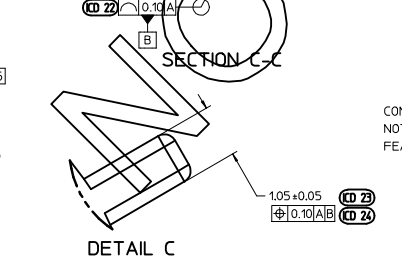
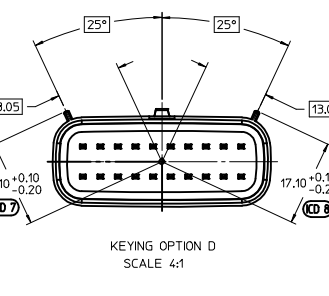
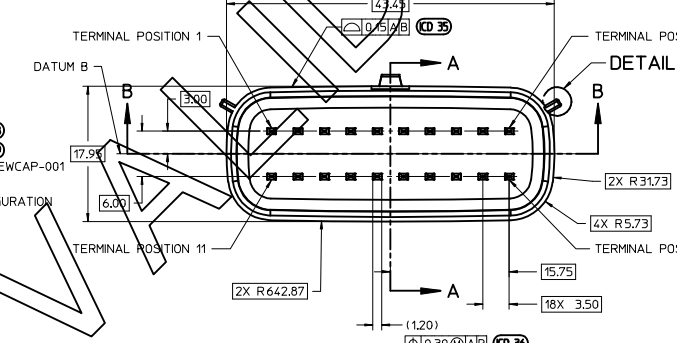
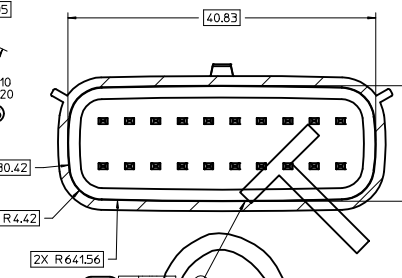
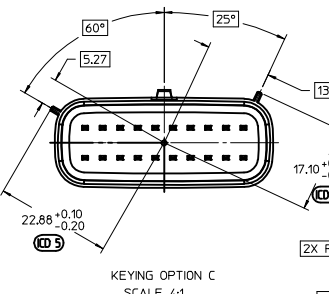
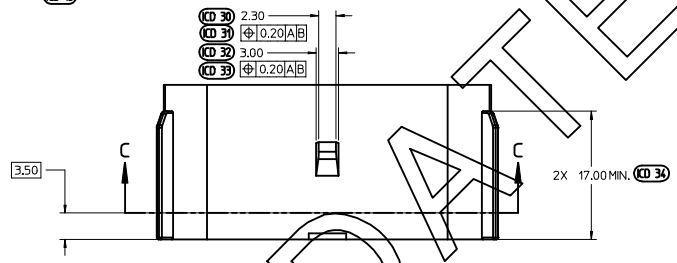
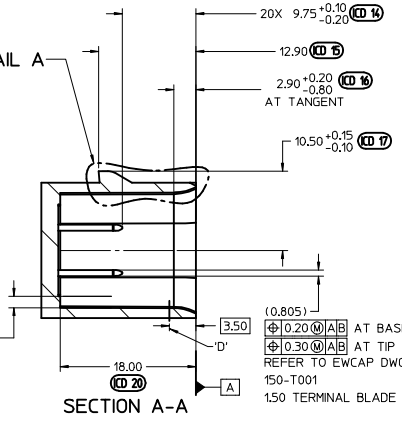
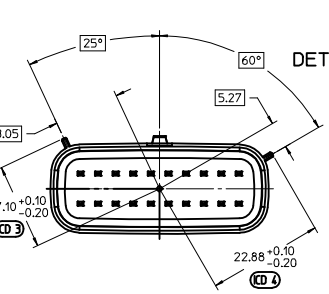
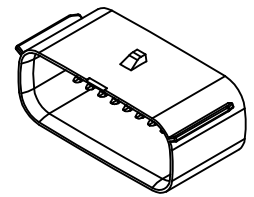
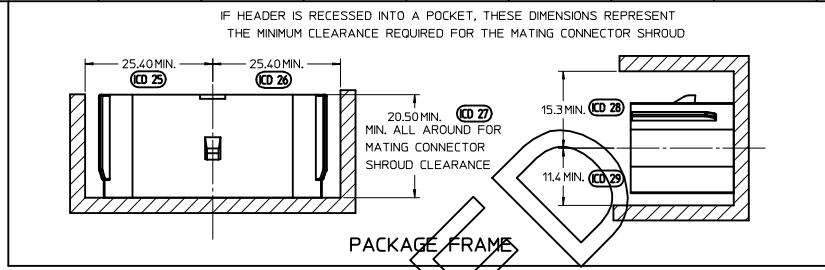
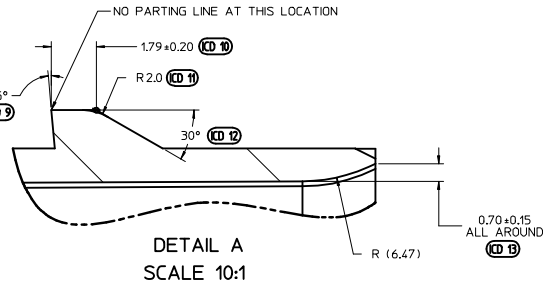
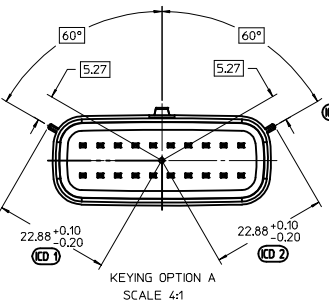

CONSTRUCTION BELOW THIS SURFACE IS NOT CONTROLLED BY EWCAP. NO PLASTIC FEATURES MAY EXTEND ABOVE THIS SURFACE.

SURFACE MUST BE FREE OF SURFACE DEFECTS AND PARTING LINES FOR SEALING ALL AROUND

150-S-020-2-D02	D	STONE GRAY
150-S-020-2-C02	C	DK GRAY
150-S-020-2-B02	B	LT GRAY
150-S-020-2-A02	A	BLACK
P/N	OPTION	MATING CONNECTOR COLOR

DETAIL C  
SCALE 20:1  
APPLIES 2X  
SEE KEYING OPTION VIEWS FOR POSITIONS

ENTER DESCRIPTION EC NO: UA02017-0214 DRAWING NO: 2016/09/09 CHKD: APPR:KOSKI B1	DIMENSION STYLE QUALITY SYMBOLS GENERAL TOLERANCES (UNLESS SPECIFIED) DIMENSION STYLE SCALE DESIGN UNITS THIRD ANGLE PROJECTION	DRAWN BY DATE APPROFF ITT 2014/05/14 CHECKED BY DATE APPROVED BY DATE VKOSHY 2014/06/27 MATERIAL NO. SEE NOTE 2a. THIS DRAWING CONTAINS INFORMATION THAT IS PROPRIETARY TO MOLEX INCORPORATED AND SHOULD NOT BE USED WITHOUT WRITTEN PERMISSION	TITLE MX150 RCPT DUAL ROW SEALED ASSEMBLY MAT SEAL molex DOCUMENT NO. SD-33472-0001 SHEET NO. 9 OF 9	
	DIMENSION STYLE MM ONLY SCALE 3:1 DESIGN UNITS METRIC	DRAWN BY DATE APPROFF ITT 2014/05/14 CHECKED BY DATE APPROVED BY DATE VKOSHY 2014/06/27 MATERIAL NO. SEE NOTE 2a. THIS DRAWING CONTAINS INFORMATION THAT IS PROPRIETARY TO MOLEX INCORPORATED AND SHOULD NOT BE USED WITHOUT WRITTEN PERMISSION	TITLE MX150 RCPT DUAL ROW SEALED ASSEMBLY MAT SEAL molex DOCUMENT NO. SD-33472-0001 SHEET NO. 9 OF 9	DIMENSION STYLE MM ONLY SCALE 3:1 DESIGN UNITS METRIC
	DIMENSION STYLE MM ONLY SCALE 3:1 DESIGN UNITS METRIC	DRAWN BY DATE APPROFF ITT 2014/05/14 CHECKED BY DATE APPROVED BY DATE VKOSHY 2014/06/27 MATERIAL NO. SEE NOTE 2a. THIS DRAWING CONTAINS INFORMATION THAT IS PROPRIETARY TO MOLEX INCORPORATED AND SHOULD NOT BE USED WITHOUT WRITTEN PERMISSION	TITLE MX150 RCPT DUAL ROW SEALED ASSEMBLY MAT SEAL molex DOCUMENT NO. SD-33472-0001 SHEET NO. 9 OF 9	DIMENSION STYLE MM ONLY SCALE 3:1 DESIGN UNITS METRIC
	DIMENSION STYLE MM ONLY SCALE 3:1 DESIGN UNITS METRIC	DRAWN BY DATE APPROFF ITT 2014/05/14 CHECKED BY DATE APPROVED BY DATE VKOSHY 2014/06/27 MATERIAL NO. SEE NOTE 2a. THIS DRAWING CONTAINS INFORMATION THAT IS PROPRIETARY TO MOLEX INCORPORATED AND SHOULD NOT BE USED WITHOUT WRITTEN PERMISSION	TITLE MX150 RCPT DUAL ROW SEALED ASSEMBLY MAT SEAL molex DOCUMENT NO. SD-33472-0001 SHEET NO. 9 OF 9	DIMENSION STYLE MM ONLY SCALE 3:1 DESIGN UNITS METRIC



MX150 RECEPTACLE 2X2 SEALED ASSEMBLY MAT SEAL  
BOM AND PIN OUT SHEET

ASSEMBLY DESCRIPTION	ASSEMBLY PART NUMBER	COMPONENT						BLOCKED TERMINALS										STATUS	COMMENTS	OPTIONAL ATTACHMENTS SOLD SEPERATELY					
		THE PRESENCE OF AN ABBREVIATION INDICATES THE PRESENCE OF THAT COMPONENT.						CAVITY WITH A NUMBER INDICATES BLOCKED TERMINAL POSITION CAVITY WITHOUT A NUMBER INDICATES OPEN TERMINAL POSITION												BACKSHELL WITH RIBS	BACKSHELL WITHOUT RIBS				
		HOUSING KEY/COLOR	GROMMET CAP	PLR	CPA	MAT SEAL	RING SEAL	1	2	3	4														
KEY A, BLACK, W/O CPA	33472-4041	A-BLK	GCP	PLR		M	R	1	2											SALEABLE					
KEY C, DARK GRAY, W/O CPA	33472-4042	C-DG	GCO	PLR		M	R														SALEABLE				
KEY D, STONE GRAY, W/O CPA	33472-4043	D-SG	GCO	PLR		M	R														SALEABLE				
KEY C, DARK GRAY, W/CPA	33472-4044	C-DG	GCO	PLR	CPA	M	R														SALEABLE				
KEY D, STONE GRAY, W/CPA	33472-4045	D-SG	GCO	PLR	CPA	M	R														SALEABLE				
KEY C, DARK GRAY, W/O CPA	33472-4046	C-DG	GCP	PLR		M	R	1	2	3	4										SALEABLE				
KEY D, STONE GRAY, W/O CPA	33472-4047	D-SG	GCP	PLR		M	R	1	2	3	4										SALEABLE				
KEY A, BLACK, W/O CPA	33472-4048	A-BLK	GCP	PLR		M	R		2		4										SALEABLE				
KEY A, BLACK, W/CPA	33472-4049	A-BLK	GCP	PLR	CPA	M	R		2												SALEABLE				
KEY A, BLACK, W/CPA	33472-4050	A-BLK	GCP	PLR	CPA	M	R			3											SALEABLE				
KEY A, BLACK, W/CPA	33472-4051	A-BLK	GCP	PLR	CPA	M	R				4										SALEABLE				
KEY A, BLACK, W/O CPA	33472-4052	A-BLK	GCP	PLR		M	R		2		4										SALEABLE				
KEY A, YELLOW, W/CPA	33472-4053	A-YW	GCO	PLR	CPA	M	R														SALEABLE				
KEY A, BLACK, W/O CPA	33472-4054	A-BLK	GCP	PLR		M	R	1		3											SALEABLE				
KEY B, LIGHT GRAY, W/CPA	33472-4055	B-LG	GCP	PLR	CPA	M	R	1													SALEABLE				
KEY A, BLACK, W/O CPA	33472-4056	A-BLK	GCP	PLR		M	R	1													SALEABLE				
KEY A, BLACK, WITH CLIPSLOT, W/O CPA	33472-0501	A-BLK-CLIP	GCO	PLR		M	R														DESIGN RELEASE				
KEY B, LIGHT GRAY, WITH CLIPSLOT, W/O CPA	33472-0502	B-LG-CLIP	GCO	PLR		M	R														DESIGN RELEASE				
KEY C, DARK GRAY, WITH CLIPSLOT, W/O CPA	33472-0503	C-DG-CLIP	GCO	PLR		M	R														DESIGN RELEASE				
KEY D, STONE GRAY, WITH CLIPSLOT, W/O CPA	33472-0504	D-SG-CLIP	GCO	PLR		M	R														DESIGN RELEASE				
KEY A, YELLOW, WITH CLIPSLOT, W/O CPA	33472-0505	A-YW-CLIP	GCO	PLR		M	R														DESIGN RELEASE				
KEY A, BLACK, WITH CLIPSLOT, W/CPA	33472-0506	A-BLK-CLIP	GCO	PLR	CPA	M	R														DESIGN RELEASE				
KEY B, LIGHT GRAY, WITH CLIPSLOT, W/CPA	33472-0507	B-LG-CLIP	GCO	PLR	CPA	M	R														DESIGN RELEASE				
KEY C, DARK GRAY, WITH CLIPSLOT, W/CPA	33472-0508	C-DG-CLIP	GCO	PLR	CPA	M	R														DESIGN RELEASE				
KEY D, STONE GRAY, WITH CLIPSLOT, W/CPA	33472-0509	D-SG-CLIP	GCO	PLR	CPA	M	R														DESIGN RELEASE				
KEY A, YELLOW, WITH CLIPSLOT, W/CPA	33472-0510	A-YW-CLIP	GCO	PLR	CPA	M	R														DESIGN RELEASE				

MX150 RECEPTACLE 2X3 SEALED ASSEMBLY MAT SEAL  
BOM AND PIN OUT SHEET

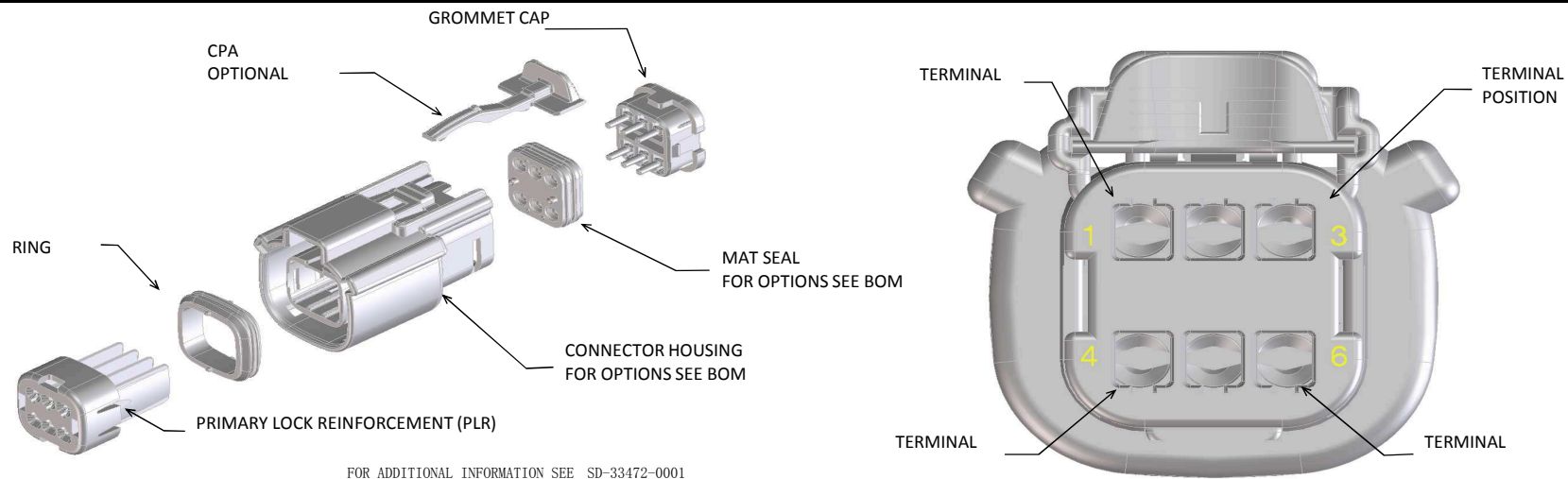

ABBREVIATION	DESCRIPTION	COLOR	MATERIAL
A-BLK	HOUSING, KEYING OPTION A	BLACK	SPS/NYLON GF20
B-LG	HOUSING, KEYING OPTION B	LIGHT GRAY	SPS/NYLON GF20
C-BR	HOUSING, KEYING OPTION C	BROWN	SPS/NYLON GF20
D-GR	HOUSING, KEYING OPTION D	GREEN	SPS/NYLON GF20
C-DG	HOUSING, KEYING OPTION C	DARK GRAY	SPS/NYLON GF20
D-SG	HOUSING, KEYING OPTION D	STONE GRAY	SPS/NYLON GF20
A-YW	HOUSING, KEYING OPTION A	YELLOW	SPS/NYLON GF20
A-BLK-CLIP	HOUSING, KEYING OPTION A WITH CLIPSLOT	BLACK	SPS/NYLON GF20
B-LG-CLIP	HOUSING, KEYING OPTION B WITH CLIPSLOT	LIGHT GRAY	SPS/NYLON GF20
C-BR-CLIP	HOUSING, KEYING OPTION C WITH CLIPSLOT	BROWN	SPS/NYLON GF20
D-GR-CLIP	HOUSING, KEYING OPTION D WITH CLIPSLOT	GREEN	SPS/NYLON GF20
C-DG-CLIP	HOUSING, KEYING OPTION C WITH CLIPSLOT	DARK GRAY	SPS/NYLON GF20
D-SG-CLIP	HOUSING, KEYING OPTION D WITH CLIPSLOT	STONE GRAY	SPS/NYLON GF20
A-SG-CLIP	HOUSING, KEYING OPTION A WITH CLIPSLOT	YELLOW	SPS/NYLON GF20
GC	GROMMET CAP	BLACK	SPS/NYLON GF20
PLR	PLR	NATURAL	SPS/NYLON GF20
CPA	CPA	RED	PBT GF30
M	MAT SEAL	LIGHT BLUE	INHERENTLY LUBRICATED SILICONE
R	RING SEAL	RUST RED	INHERENTLY LUBRICATED SILICONE

FOR ADDITIONAL INFORMATION SEE SD-33472-0001

ASSEMBLY DESCRIPTION	ASSEMBLY PART NUMBER	COMPONENT						BLOCKED TERMINALS						STATUS	COMMENTS	OPTIONAL ATTACHMENTS SOLD SEPARATELY			
		THE PRESENCE OF AN ABBREVIATION INDICATES THE PRESENCE OF THAT COMPONENT.						CAVITY WITH A NUMBER INDICATES BLOCKED TERMINAL POSITION CAVITY WITHOUT A NUMBER INDICATES OPEN TERMINAL POSITION								BACKSHELL WITH RIBS	BACKSHELL WITHOUT RIBS		
		HOUSING KEY/COLOR	GROMMET CAP	PLR	CPA	MAT SEAL	RING SEAL	1	2	3	4	5	6						
KEY A, BLACK, W/O CPA	33472-0601	A-BLK	GC	PLR		M	R									SALEABLE		34951-0610	34951-0620
KEY B, LIGHT GRAY, W/O CPA	33472-0602	B-LG	GC	PLR		M	R									SALEABLE		34951-0610	34951-0620
KEY C, BROWN, W/O CPA	33472-0603	C-BR	GC	PLR		M	R									NOT RECOMMENDED	SEE P/N 33472-0669	34951-0610	34951-0620
KEY D, GREEN, W/O CPA	33472-0604	D-GR	GC	PLR		M	R									NOT RECOMMENDED	SEE P/N 33472-0668	34951-0610	34951-0620
VOID KEY	33472-0605																		
KEY A, BLACK, W/CPA	33472-0606	A-BLK	GC	PLR	CPA	M	R									SALEABLE		34951-0610	34951-0620
KEY B, LIGHT GRAY, W/CPA	33472-0607	B-LG	GC	PLR	CPA	M	R									SALEABLE		34951-0610	34951-0620
KEY C, BROWN, W/CPA	33472-0608	C-BR	GC	PLR	CPA	M	R									NOT RECOMMENDED	SEE P/N 33472-0670	34951-0610	34951-0620
KEY D, GREEN, W/CPA	33472-0609	D-GR	GC	PLR	CPA	M	R									NOT RECOMMENDED	SEE P/N 33472-0671	34951-0610	34951-0620
VOID KEY	33472-0610																		
KEY A, BLACK, W/O CPA	33472-0611	A-BLK	GC	PLR		M	R			3						SALEABLE	SAME AS P/N 33472-0658	34951-0610	34951-0620
KEY B, LIGHT GRAY, W/O CPA	33472-0612	B-LG	GC	PLR		M	R			3						SALEABLE		34951-0610	34951-0620
KEY C, BROWN, W/O CPA	33472-0613	C-BR	GC	PLR		M	R			3						NOT RECOMMENDED		34951-0610	34951-0620
KEY D, GREEN, W/O CPA	33472-0614	D-GR	GC	PLR		M	R			3						NOT RECOMMENDED		34951-0610	34951-0620
VOID KEY	33472-0615																		
KEY A, BLACK, W/CPA	33472-0616	A-BLK	GC	PLR	CPA	M	R			3						SALEABLE		34951-0610	34951-0620
KEY B, LIGHT GRAY, W/CPA	33472-0617	B-LG	GC	PLR	CPA	M	R			3						SALEABLE		34951-0610	34951-0620
KEY C, BROWN, W/CPA	33472-0618	C-BR	GC	PLR	CPA	M	R			3						NOT RECOMMENDED		34951-0610	34951-0620
KEY D, GREEN, W/CPA	33472-0619	D-GR	GC	PLR	CPA	M	R			3						NOT RECOMMENDED		34951-0610	34951-0620
VOID KEY	33472-0620																		
KEY A, BLACK, W/O CPA	33472-0621	A-BLK	GC	PLR		M	R			3	4					SALEABLE		34951-0610	34951-0620
KEY B, LIGHT GRAY, W/O CPA	33472-0622	B-LG	GC	PLR		M	R			3	4					SALEABLE		34951-0610	34951-0620
KEY C, BROWN, W/O CPA	33472-0623	C-BR	GC	PLR		M	R			3	4					NOT RECOMMENDED		34951-0610	34951-0620
KEY D, GREEN, W/O CPA	33472-0624	D-GR	GC	PLR		M	R			3	4					NOT RECOMMENDED		34951-0610	34951-0620
VOID KEY	33472-0625																		
KEY A, BLACK, W/CPA	33472-0626	A-BLK	GC	PLR	CPA	M	R			3	4					SALEABLE		34951-0610	34951-0620
KEY B, LIGHT GRAY, W/CPA	33472-0627	B-LG	GC	PLR	CPA	M	R			3	4					SALEABLE		34951-0610	34951-0620
KEY C, BROWN, W/CPA	33472-0628	C-BR	GC	PLR	CPA	M	R			3	4					NOT RECOMMENDED		34951-0610	34951-0620
KEY D, GREEN, W/CPA	33472-0629	D-GR	GC	PLR	CPA	M	R			3	4					NOT RECOMMENDED		34951-0610	34951-0620
VOID KEY	33472-0630																		
KEY A, BLACK, W/O CPA, W/O MAT SEAL	33472-0631	A-BLK	GC	PLR			R									NOT VALIDATED		34951-0610	34951-0620
KEY B, LIGHT GRAY, W/O CPA, W/O MAT SEAL	33472-0632	B-LG	GC	PLR			R									NOT VALIDATED		34951-0610	34951-0620
KEY C, BROWN, W/O CPA, W/O MAT SEAL	33472-0633	C-BR	GC	PLR			R									NOT RECOMMENDED	NOT VALIDATED	34951-0610	34951-0620
KEY D, GREEN, W/O CPA, W/O MAT SEAL	33472-0634	D-GR	GC	PLR			R									NOT RECOMMENDED	NOT VALIDATED	34951-0610	34951-0620
VOID KEY	33472-0635																		
KEY A, BLACK, W/O CPA	33472-0636	A-BLK	GC	PLR		M	R	1	2	3	4	5	6			SALEABLE		34951-0610	34951-0620
KEY B, LIGHT GRAY, W/O CPA	33472-0637	B-LG	GC	PLR		M	R	1	2	3	4	5	6			SALEABLE		34951-0610	34951-0620
KEY C, BROWN, W/O CPA	33472-0638	C-BR	GC	PLR		M	R	1	2	3	4	5	6			NOT RECOMMENDED		34951-0610	34951-0620
KEY D, GREEN, W/O CPA	33472-0639	D-GR	GC	PLR		M	R	1	2	3	4	5	6			NOT RECOMMENDED		34951-0610	34951-0620
VOID KEY	33472-0640																		
KEY A, BLACK, W/O CPA	33472-0641	A-BLK	GC	PLR		M	R		2	3	4	5				SALEABLE		34951-0610	34951-0620
KEY A, BLACK, W/O CPA	33472-0642	A-BLK	GC	PLR		M	R			3	4					SALEABLE		34951-0610	34951-0620
KEY A, BLACK, W/CPA	33472-0643	A-BLK	GC	PLR	CPA	M	R	1		3	4					SALEABLE		34951-0610	34951-0620
KEY B, LIGHT GRAY, W/CPA	33472-0644	B-LG	GC	PLR	CPA	M	R	1		3	4					SALEABLE		34951-0610	34951-0620
KEY C, BROWN, W/CPA	33472-0645	C-BR	GC	PLR	CPA	M	R	1		3	4					NOT RECOMMENDED		34951-0610	34951-0620
KEY D, GREEN, W/CPA	33472-0646	D-GR	GC	PLR	CPA	M	R	1		3	4					NOT RECOMMENDED		34951-0610	34951-0620
VOID KEY	33472-0647																		
KEY A, BLACK, W/O CPA	33472-0648	A-BLK	GC	PLR		M	R	1		3	4		6			SALEABLE		34951-0610	34951-0620
KEY B, LIGHT GRAY, W/O CPA	33472-0649	B-LG	GC	PLR		M	R	1		3	4		6			SALEABLE		34951-0610	34951-0620
KEY C, BROWN, W/O CPA	33472-0650	C-BR	GC	PLR		M	R	1		3	4		6			NOT RECOMMENDED		34951-0610	34951-0620
KEY D, GREEN, W/O CPA	33472-0651	D-GR	GC	PLR		M	R	1		3	4		6			NOT RECOMMENDED		34951-0610	34951-0620
VOID KEY	33472-0652																		
KEY A, BLACK, W/CPA	33472-0653	A-BLK	GC	PLR	CPA	M	R	1		3	4		6			SALEABLE		34951-0610	34951-0620
KEY B, LIGHT GRAY, W/CPA	33472-0654	B-LG	GC	PLR	CPA	M	R	1		3	4		6			SALEABLE		34951-0610	34951-0620
KEY C, BROWN, W/CPA	33472-0655	C-BR	GC	PLR	CPA	M	R	1		3	4		6			NOT RECOMMENDED		34951-0610	34951-0620
KEY D, GREEN, W/CPA	33472-0656	D-GR	GC	PLR	CPA	M	R	1		3	4		6			NOT RECOMMENDED		34951-0610	34951-0620
VOID KEY	33472-0657																		
KEY A, BLACK, W/O CPA	33472-0658	A-BLK	GC	PLR		M	R			3						SALEABLE		34951-0610	34951-0620

MX150 RECEPTACLE 2X3 SEALED ASSEMBLY MAT SEAL  
BOM AND PIN OUT SHEET

ASSEMBLY DESCRIPTION	ASSEMBLY PART NUMBER	COMPONENT						BLOCKED TERMINALS						STATUS	COMMENTS	OPTIONAL ATTACHMENTS SOLD SEPERATELY		
		THE PRESENCE OF AN ABBREVIATION INDICATES THE PRESENCE OF THAT COMPONENT.						CAVITY WITH A NUMBER INDICATES BLOCKED TERMINAL POSITION CAVITY WITHOUT A NUMBER INDICATES OPEN TERMINAL POSITION								BACKSHELL WITH RIBS	BACKSHELL WITHOUT RIBS	
		HOUSING KEY/COLOR	GROMMET CAP	PLR	CPA	MAT SEAL	RING SEAL	1	2	3	4	5	6					
KEY A, BLACK, W/O CPA	33472-0659	A-BLK	GC	PLR		M	R			3			5	6	SALEABLE		34951-0610	34951-0620
KEY A, BLACK, W/CPA	33472-0660	A-BLK	GC	PLR	CPA	M	R	1		3	4		5	6	SALEABLE		34951-0610	34951-0620
KEY A, BLACK, W/O CPA	33472-0661	A-BLK	GC	PLR		M	R		2				5		SALEABLE		34951-0610	34951-0620
KEY A, BLACK, W/O CPA	33472-0662	A-BLK	GC	PLR		M	R		2				5		SALEABLE		34951-0610	34951-0620
KEY A, BLACK, W/O CPA	33472-0663	A-BLK	GC	PLR		M	R						5	6	SALEABLE		34951-0610	34951-0620
KEY A, BLACK, W/O CPA	33472-0664	A-BLK	GC	PLR		M	R					4	5	6	SALEABLE		34951-0610	34951-0620
KEY A, BLACK, W/O CPA	33472-0665	A-BLK	GC	PLR		M	R	1							SALEABLE		34951-0610	34951-0620
KEY A, BLACK, W/O CPA	33472-0666	A-BLK	GC	PLR		M	R		2				5	6	SALEABLE		34951-0610	34951-0620
KEY A, BLACK, W/O CPA	33472-0667	A-BLK	GC	PLR		M	R	1		3			5	6	SALEABLE		34951-0610	34951-0620
KEY C, DARK GRAY, W/O CPA	33472-0668	C-DG	GC	PLR		M	R								SALEABLE		34951-0610	34951-0620
KEY D, STONE GRAY, W/O CPA	33472-0669	D-SG	GC	PLR		M	R								SALEABLE		34951-0610	34951-0620
KEY C, DARK GRAY, W/CPA	33472-0670	C-DG	GC	PLR	CPA	M	R								SALEABLE		34951-0610	34951-0620
KEY D, STONE GRAY, W/CPA	33472-0671	D-SG	GC	PLR	CPA	M	R								SALEABLE		34951-0610	34951-0620
KEY B, LIGHT GRAY, W/O CPA	33472-0672	B-LG	GC	PLR		M	R						5		SALEABLE		34951-0610	34951-0620
KEY A, BLACK, W/O CPA	33472-0673	A-BLK	GC	PLR		M	R							6	SALEABLE		34951-0610	34951-0620
KEY A, BLACK, W/CPA	33472-0674	A-BLK	GC	PLR	CPA	M	R						5	6	SALEABLE		34951-0610	34951-0620
KEY A, BLACK, W/CPA	33472-0675	A-BLK	GC	PLR	CPA	M	R							6	SALEABLE		34951-0610	34951-0620
KEY B, LIGHT GRAY, W/CPA	33472-0676	B-LG	GC	PLR	CPA	M	R	1					5		SALEABLE		34951-0610	34951-0620
KEY B, LIGHT GRAY, W/O CPA	33472-0677	B-LG	GC	PLR		M	R	1					5		SALEABLE		34951-0610	34951-0620
KEY B, LIGHT GRAY, W/O CPA	33472-0678	B-LG	GC	PLR		M	R						5	6	SALEABLE		34951-0610	34951-0620
KEY A, BLACK, W/CPA	33472-0679	A-BLK	GC	PLR	CPA	M	R	1	2	3					SALEABLE		34951-0610	34951-0620
KEY A, BLACK, W/O CPA	33472-0680	A-BLK	GC	PLR		M	R	1	2	3					SALEABLE		34951-0610	34951-0620
KEY A, BLACK, W/CPA	33472-0681	A-BLK	GC	PLR	CPA	M	R		2						SALEABLE		34951-0610	34951-0620
KEY A, YELLOW, W/CPA	33472-0682	A-YW	GC	PLR	CPA	M	R								SALEABLE		34951-0610	34951-0620
KEY A, BLACK, W/O CPA	33472-0683	A-BLK	GC	PLR		M	R			3	4		5	6	SALEABLE		34951-0610	34951-0620
KEY A, BLACK, W/CPA	33472-0684	A-BLK	GC	PLR	CPA	M	R			3					SALEABLE		34951-0610	34951-0620
KEY B, LIGHT GRAY, W/CPA	33472-0685	B-LG	GC	PLR	CPA	M	R	1	2	3	4		5	6	SALEABLE		34951-0610	34951-0620
KEY B, LIGHT GRAY, W/CPA	33472-0686	B-LG	GC	PLR	CPA	M	R		2	3					SALEABLE		34951-0610	34951-0620
KEY A, BLACK, W/O CPA	33472-0687	A-BLK	GC	PLR		M	R	1		3	4				SALEABLE		34951-0610	34951-0620
KEY A, BLACK, W/CPA	33472-0688	A-BLK	GC	PLR	CPA	M	R			4			5	6	SALEABLE		34951-0610	34951-0620
KEY A, BLACK, W/CPA	33472-0689	A-BLK	GC	PLR	CPA	M	R			4					SALEABLE		34951-0610	34951-0620
KEY B, LIGHT GRAY, W/CPA	33472-0690	B-LG	GC	PLR	CPA	M	R			4					SALEABLE		34951-0610	34951-0620
KEY A, BLACK, W/CPA	33472-0691	A-BLK	GC	PLR	CPA	M	R	1		3			5		SALEABLE		34951-0610	34951-0620
KEY A, BLACK, W/CPA	33472-0692	A-BLK	GC	PLR	CPA	M	R		2		4			6	SALEABLE		34951-0610	34951-0620
KEY A, BLACK, WITH CLIPSLOT, W/O CPA	33472-0701	A-BLK-CLIP	GC	PLR		M	R								SALEABLE			
KEY B, LIGHT GRAY, WITH CLIPSLOT, W/O CPA	33472-0702	B-LG-CLIP	GC	PLR		M	R								SALEABLE			
KEY C, BROWN, WITH CLIPSLOT, W/O CPA	33472-0703	C-BR-CLIP	GC	PLR		M	R								NOT RECOMMENDED—SEE P/N 33472-0714			
KEY D, GREEN, WITH CLIPSLOT, W/O CPA	33472-0704	D-GR-CLIP	GC	PLR		M	R								NOT RECOMMENDED—SEE P/N 33472-0715			
KEY A, BLACK, WITH CLIPSLOT, W/CPA	33472-0705	A-BLK-CLIP	GC	PLR	CPA	M	R								SALEABLE			
KEY B, LIGHT GRAY, WITH CLIPSLOT, W/CPA	33472-0706	B-LG-CLIP	GC	PLR	CPA	M	R								SALEABLE			
KEY C, BROWN, WITH CLIPSLOT, W/CPA	33472-0707	C-BR-CLIP	GC	PLR	CPA	M	R								NOT RECOMMENDED—SEE P/N 33472-0716			
KEY D, GREEN, WITH CLIPSLOT, W/CPA	33472-0708	D-GR-CLIP	GC	PLR	CPA	M	R								NOT RECOMMENDED—SEE P/N 33472-0717			
KEY A, BLACK, WITH CLIPSLOT, W/O CPA	33472-0709	A-BLK-CLIP	GC	PLR		M	R			3					SALEABLE			
KEY A, BLACK, WITH CLIPSLOT, W/O CPA	33472-0710	A-BLK-CLIP	GC	PLR		M	R		2	3	4		5		SALEABLE			
KEY A, BLACK, WITH CLIPSLOT, W/O CPA	33472-0711	A-BLK-CLIP	GC	PLR		M	R						5	6	SALEABLE			
KEY A, BLACK, WITH CLIPSLOT, W/O CPA	33472-0712	A-BLK-CLIP	GC	PLR		M	R			3	4				SALEABLE			
KEY B, LIGHT GRAY, WITH CLIPSLOT, W/O CPA	33472-0713	B-LG-CLIP	GC	PLR		M	R	1					5		SALEABLE			
KEY C, DARK GRAY, WITH CLIPSLOT, W/O CPA	33472-0714	C-DG-CLIP	GC	PLR		M	R								SALEABLE			
KEY D, STONE GRAY, WITH CLIPSLOT, W/O CPA	33472-0715	D-SG-CLIP	GC	PLR		M	R								SALEABLE			
KEY C, DARK GRAY, WITH CLIPSLOT, W/CPA	33472-0716	C-DG-CLIP	GC	PLR	CPA	M	R								SALEABLE			
KEY D, STONE GRAY, WITH CLIPSLOT, W/CPA	33472-0717	D-SG-CLIP	GC	PLR	CPA	M	R								SALEABLE			
KEY A, BLACK, WITH CLIPSLOT, W/O CPA	33472-0718	A-BLK-CLIP	GC	PLR		M	R			3				6	SALEABLE			
KEY B, LIGHT GRAY, WITH CLIPSLOT, W/CPA	33472-0719	B-LG-CLIP	GC	PLR	CPA	M	R	1					5		SALEABLE			
KEY B, LIGHT GRAY, WITH CLIPSLOT, W/O CPA	33472-0720	B-LG-CLIP	GC	PLR		M	R						5		SALEABLE			
KEY C, DARK GRAY, WITH CLIPSLOT, W/O CPA	33472-0721	C-DG-CLIP	GC	PLR		M	R			3					SALEABLE			
KEY A, BLACK, WITH CLIPSLOT, W/O CPA	33472-0722	A-BLK-CLIP	GC	PLR		M	R			4			5	6	SALEABLE			
KEY A, BLACK, WITH CLIPSLOT, W/O CPA	33472-0723	A-BLK-CLIP	GC	PLR		M	R		2	3			5	6	SALEABLE			
KEY A, BLACK, WITH CLIPSLOT, W/O CPA	33472-0724	A-BLK-CLIP	GC	PLR		M	R		2				6		SALEABLE			
KEY A, BLACK, WITH CLIPSLOT, W/O CPA	33472-0725	A-BLK-CLIP	GC	PLR		M	R			3			5	6	SALEABLE			
KEY A, BLACK, WITH CLIPSLOT, W/O CPA	33472-0726	A-BLK-CLIP	GC	PLR		M	R						6		SALEABLE			
KEY A, BLACK, WITH CLIPSLOT, W/O CPA	33472-0727	A-BLK-CLIP	GC	PLR		M	R						6		SALEABLE			
KEY A, BLACK, WITH CLIPSLOT, W/O CPA	33472-0728	A-BLK-CLIP	GC	PLR		M	R	1	2	3	4		5	6	SALEABLE			
KEY A, BLACK, WITH CLIPSLOT, W/O CPA	33472-0729	A-BLK-CLIP	GC	PLR		M	R	1	2	3	4		5	6	SALEABLE			
KEY A, BLACK, WITH CLIPSLOT, W/O CPA	33472-0730	A-BLK-CLIP	GC	PLR		M	R				4				SALEABLE			
KEY A, BLACK, WITH CLIPSLOT, W/O CPA	33472-0731	A-BLK-CLIP	GC	PLR		M	R				4			6	SALEABLE			
KEY B, LIGHT GRAY, WITH CLIPSLOT, W/O CPA	33472-0732	B-LG-CLIP	GC	PLR		M	R				4			6	SALEABLE			
KEY A, BLACK, W/CPA	33472-0733	A-BLK	GC	PLR	CPA	M	R		2				5		SALEABLE		34951-0610	34951-0620
KEY A, BLACK, WITH CLIPSLOT, W/O CPA	33472-0734	A-BLK-CLIP	GC	PLR		M	R						5		SALEABLE			
KEY A, BLACK, W/O CPA	33472-0735	A-BLK	GC	PLR		M	R						5		SALEABLE			
KEY B, LIGHT GRAY, W/O CPA	33472-0736	B-LG	GC	PLR		M	R				4		5	6	SALEABLE			
KEY A, BLACK, W/CPA	33472-0737	A-BLK	GC	PLR	CPA	M	R	1							SALEABLE			
KEY B, LIGHT GRAY, W/CPA	33472-0738	B-LG	GC	PLR	CPA	M	R	1							SALEABLE			
KEY A, BLACK, WITH CLIPSLOT, W/CPA	33472-0739	A-BLK-CLIP	GC	PLR	CPA	M	R	1		2			5	6	SALEABLE			
KEY A, BLACK, WITH CLIPSLOT, W/CPA	33472-0740	A-BLK-CLIP	GC	PLR	CPA	M	R		2	3	4		5		SALEABLE			
KEY A, BLACK, W/O CPA	33472-0741	A-BLK	GC	PLR		M	R				3			6	SALEABLE			
KEY A, BLACK, W/O CPA	33472-0742	A-BLK	GC	PLR		M	R	1					5	6	SALEABLE			
KEY B, LIGHT GRAY, W/O CPA	33472-0743	B-LG	GC	PLR		M	R	1					5	6	SALEABLE			
KEY A, BLACK, WITH CLIPSLOT, W/CPA	33472-0744	A-BLK-CLIP	GC	PLR	CPA	M	R				3				SALEABLE			
KEY A, BLACK, WITH CLIPSLOT, W/O CPA	33472-0745	A-BLK-CLIP	GC	PLR		M	R	1			4				SALEABLE			

MX150 RECEPTACLE 2X4 SEALED ASSEMBLY MAT SEAL  
BOM AND PIN OUT SHEET

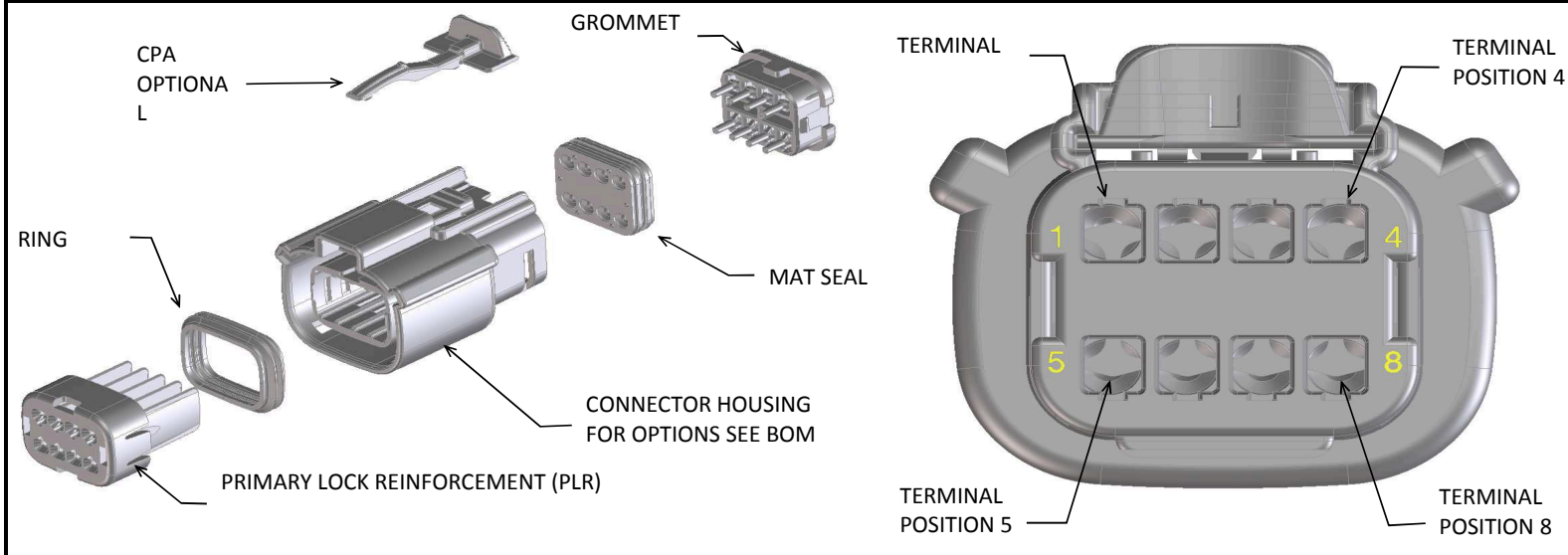

ABBREVIATION	DESCRIPTION	COLOR	MATERIAL
A-BLK	HOUSING, KEYING OPTION A	BLACK	SPS/NYLON GF20
B-LG	HOUSING, KEYING OPTION B	LIGHT GRAY	SPS/NYLON GF20
C-BR	HOUSING, KEYING OPTION C	BROWN	SPS/NYLON GF20
D-GR	HOUSING, KEYING OPTION D	GREEN	SPS/NYLON GF20
C-DG	HOUSING, KEYING OPTION C	DARK GRAY	SPS/NYLON GF20
D-SG	HOUSING, KEYING OPTION D	STONE GRAY	SPS/NYLON GF20
D-BLK	HOUSING, KEYING OPTION D	BLACK	SPS/NYLON GF20
A-YW	HOUSING, KEYING OPTION A	YELLOW	SPS/NYLON GF20
A-BLK-CLIP	HOUSING, KEYING OPTION A WITH CLIPSLOT	BLACK	SPS/NYLON GF20
B-LG-CLIP	HOUSING, KEYING OPTION B WITH CLIPSLOT	LIGHT GRAY	SPS/NYLON GF20
C-BR-CLIP	HOUSING, KEYING OPTION C WITH CLIPSLOT	BROWN	SPS/NYLON GF20
D-GR-CLIP	HOUSING, KEYING OPTION D WITH CLIPSLOT	GREEN	SPS/NYLON GF20
C-DG-CLIP	HOUSING, KEYING OPTION C WITH CLIPSLOT	DARK GRAY	SPS/NYLON GF20
D-SG-CLIP	HOUSING, KEYING OPTION D WITH CLIPSLOT	STONE GRAY	SPS/NYLON GF20
D-BLK-CLIP	HOUSING, KEYING OPTION D WITH CLIPSLOT	BLACK	SPS/NYLON GF20
GCO	GROMMET CAP (OPEN)	BLACK	SPS/NYLON GF20
GCP	GROMMET CAP (PLUGGED)	BLACK	SPS/NYLON GF20
PLR	PLR	NATURAL	SPS/NYLON GF20
CPA	CPA	RED	PBT GF30
M	MAT SEAL	LIGHT BLUE	INHERENTLY LUBRICATED SILICONE
RG	RING SEAL	GREEN	INHERENTLY LUBRICATED SILICONE
RR	RING SEAL	RUST RED	INHERENTLY LUBRICATED SILICONE

FOR ADDITIONAL INFORMATION SEE SD-33472-0001

ASSEMBLY DESCRIPTION	ASSEMBLY PART NUMBER	COMPONENT						BLOCKED TERMINALS								STATUS	COMMENTS	OPTIONAL ATTACHMENTS SOLD SEPARATELY		
		THE PRESENCE OF AN ABBREVIATION INDICATES THE PRESENCE OF THAT COMPONENT.							CAVITY WITH A NUMBER INDICATES BLOCKED TERMINAL POSITION CAVITY WITHOUT A NUMBER INDICATES OPEN TERMINAL POSITION									BACKSHELL WITH RIBS	BACKSHELL WITHOUT RIBS	
		HOUSING KEY/COLOR	GROMMET CAP	PLR	CPA	MAT SEAL	RING SEAL	1	2	3	4	5	6	7	8					
KEY A, BLACK, W/O CPA	33472-0801	A-BLK	GCO	PLR		M	RG										PLANNED OBSOLESCENCE		34951-0810	34951-0820
KEY B, LIGHT GRAY, W/O CPA	33472-0802	B-LG	GCO	PLR		M	RG										PLANNED OBSOLESCENCE		34951-0810	34951-0820
KEY C, BROWN, W/O CPA	33472-0803	C-BR	GCO	PLR		M	RG										PLANNED OBSOLESCENCE	SEE P/N 33472-0879	34951-0810	34951-0820
KEY D, GREEN, W/O CPA	33472-0804	D-GR	GCO	PLR		M	RG										PLANNED OBSOLESCENCE	SEE P/N 33472-0880	34951-0810	34951-0820
KEY D, BLACK, W/O CPA	33472-0805	D-BLK	GCO	PLR		M	RG										PLANNED OBSOLESCENCE		34951-0810	34951-0820
KEY A, BLACK, W/CPA	33472-0806	A-BLK	GCO	PLR	CPA	M	RG										PLANNED OBSOLESCENCE		34951-0810	34951-0820
KEY B, LIGHT GRAY, W/CPA	33472-0807	B-LG	GCO	PLR	CPA	M	RG										PLANNED OBSOLESCENCE		34951-0810	34951-0820
KEY C, BROWN, W/CPA	33472-0808	C-BR	GCO	PLR	CPA	M	RG										PLANNED OBSOLESCENCE	SEE P/N 33472-0881	34951-0810	34951-0820
KEY D, GREEN, W/CPA	33472-0809	D-GR	GCO	PLR	CPA	M	RG										PLANNED OBSOLESCENCE	SEE P/N 33472-0882	34951-0810	34951-0820
VOID KEY	33472-0810																			
KEY A, BLACK, W/O CPA	33472-0811	A-BLK	GCP	PLR		M	RG				4						PLANNED OBSOLESCENCE		34951-0810	34951-0820
KEY B, LIGHT GRAY, W/O CPA	33472-0812	B-LG	GCP	PLR		M	RG				4						PLANNED OBSOLESCENCE		34951-0810	34951-0820
KEY C, BROWN, W/O CPA	33472-0813	C-BR	GCP	PLR		M	RG				4						PLANNED OBSOLESCENCE		34951-0810	34951-0820
KEY D, GREEN, W/O CPA	33472-0814	D-GR	GCP	PLR		M	RG				4						PLANNED OBSOLESCENCE		34951-0810	34951-0820
VOID KEY	33472-0815																			
KEY A, BLACK, W/CPA	33472-0816	A-BLK	GCP	PLR	CPA	M	RG				4						PLANNED OBSOLESCENCE		34951-0810	34951-0820
KEY B, LIGHT GRAY, W/CPA	33472-0817	B-LG	GCP	PLR	CPA	M	RG				4						PLANNED OBSOLESCENCE		34951-0810	34951-0820
KEY C, BROWN, W/CPA	33472-0818	C-BR	GCP	PLR	CPA	M	RG				4						PLANNED OBSOLESCENCE		34951-0810	34951-0820
KEY D, GREEN, W/CPA	33472-0819	D-GR	GCP	PLR	CPA	M	RG				4						PLANNED OBSOLESCENCE	SEE P/N 33472-1009	34951-0810	34951-0820
VOID KEY	33472-0820																			
KEY A, BLACK, W/O CPA	33472-0821	A-BLK	GCP	PLR		M	RG				4	5					PLANNED OBSOLESCENCE		34951-0810	34951-0820
KEY B, LIGHT GRAY, W/O CPA	33472-0822	B-LG	GCP	PLR		M	RG				4	5					PLANNED OBSOLESCENCE		34951-0810	34951-0820
KEY C, BROWN, W/O CPA	33472-0823	C-BR	GCP	PLR		M	RG				4	5					PLANNED OBSOLESCENCE		34951-0810	34951-0820
KEY D, GREEN, W/O CPA	33472-0824	D-GR	GCP	PLR		M	RG				4	5					PLANNED OBSOLESCENCE		34951-0810	34951-0820
VOID KEY	33472-0825																			
KEY A, BLACK, W/CPA	33472-0826	A-BLK	GCP	PLR	CPA	M	RG				4	5					PLANNED OBSOLESCENCE		34951-0810	34951-0820
KEY B, LIGHT GRAY, W/CPA	33472-0827	B-LG	GCP	PLR	CPA	M	RG				4	5					PLANNED OBSOLESCENCE		34951-0810	34951-0820
KEY C, BROWN, W/CPA	33472-0828	C-BR	GCP	PLR	CPA	M	RG				4	5					PLANNED OBSOLESCENCE		34951-0810	34951-0820
KEY D, GREEN, W/CPA	33472-0829	D-GR	GCP	PLR	CPA	M	RG				4	5					PLANNED OBSOLESCENCE	SEE P/N 33472-1010	34951-0810	34951-0820
VOID KEY	33472-0830																			
KEY A, BLACK, W/O CPA	33472-0831	A-BLK	GCP	PLR		M	RG	1			4	5					PLANNED OBSOLESCENCE		34951-0810	34951-0820
KEY B, LIGHT GRAY, W/O CPA	33472-0832	B-LG	GCP	PLR		M	RG	1			4	5					PLANNED OBSOLESCENCE		34951-0810	34951-0820
KEY C, BROWN, W/O CPA	33472-0833	C-BR	GCP	PLR		M	RG	1			4	5					PLANNED OBSOLESCENCE		34951-0810	34951-0820
KEY D, GREEN, W/O CPA	33472-0834	D-GR	GCP	PLR		M	RG	1			4	5					PLANNED OBSOLESCENCE		34951-0810	34951-0820
VOID KEY	33472-0835																			
KEY A, BLACK, W/CPA	33472-0836	A-BLK	GCP	PLR	CPA	M	RG	1			4	5					PLANNED OBSOLESCENCE		34951-0810	34951-0820
KEY B, LIGHT GRAY, W/CPA	33472-0837	B-LG	GCP	PLR	CPA	M	RG	1			4	5					PLANNED OBSOLESCENCE		34951-0810	34951-0820
KEY C, BROWN, W/CPA	33472-0838	C-BR	GCP	PLR	CPA	M	RG	1			4	5					PLANNED OBSOLESCENCE		34951-0810	34951-0820
KEY D, GREEN, W/CPA	33472-0839	D-GR	GCP	PLR	CPA	M	RG	1			4	5					PLANNED OBSOLESCENCE		34951-0810	34951-0820
VOID KEY	33472-0840																			
KEY A, BLACK, W/O CPA	33472-0841	A-BLK	GCP	PLR		M	RG	1			4	5			8		PLANNED OBSOLESCENCE		34951-0810	34951-0820
KEY B, LIGHT GRAY, W/O CPA	33472-0842	B-LG	GCP	PLR		M	RG	1			4	5			8		PLANNED OBSOLESCENCE		34951-0810	34951-0820
KEY C, BROWN, W/O CPA	33472-0843	C-BR	GCP	PLR		M	RG	1			4	5			8		PLANNED OBSOLESCENCE		34951-0810	34951-0820
KEY D, GREEN, W/O CPA	33472-0844	D-GR	GCP	PLR		M	RG	1			4	5			8		PLANNED OBSOLESCENCE		34951-0810	34951-0820

MX150 RECEPTACLE 2X4 SEALED ASSEMBLY MAT SEAL  
BOM AND PIN OUT SHEET

ASSEMBLY DESCRIPTION	ASSEMBLY PART NUMBER	COMPONENT						BLOCKED TERMINALS								STATUS	COMMENTS	OPTIONAL ATTACHMENTS SOLD SEPERATELY		
		THE PRESENCE OF AN ABBREVIATION INDICATES THE PRESENCE OF THAT COMPONENT.						CAVITY WITH A NUMBER INDICATES BLOCKED TERMINAL POSITION CAVITY WITHOUT A NUMBER INDICATES OPEN TERMINAL POSITION										BACKSHELL WITH RIBS	BACKSHELL WITHOUT RIBS	
		HOUSING KEY/COLOR	GROMMET CAP	PLR	CPA	MAT SEAL	RING SEAL	1	2	3	4	5	6	7	8					
VOID KEY	33472-0845																			
KEY A, BLACK, W/CPA	33472-0846	A-BLK	GCP	PLR	CPA	M	RG	1			4	5			8	PLANNED OBSOLESCENCE		34951-0810	34951-0820	
KEY B, LIGHT GRAY, W/CPA	33472-0847	B-LG	GCP	PLR	CPA	M	RG	1			4	5			8	PLANNED OBSOLESCENCE		34951-0810	34951-0820	
KEY C, BROWN, W/CPA	33472-0848	C-BR	GCP	PLR	CPA	M	RG	1			4	5			8	PLANNED OBSOLESCENCE		34951-0810	34951-0820	
KEY D, GREEN, W/CPA	33472-0849	D-GR	GCP	PLR	CPA	M	RG	1			4	5			8	PLANNED OBSOLESCENCE		34951-0810	34951-0820	
VOID KEY	33472-0850																			
KEY A, BLACK, W/O CPA	33472-0851	A-BLK	GCP	PLR		M	RG	1	2	3	4	5	6	7	8	PLANNED OBSOLESCENCE		34951-0810	34951-0820	
KEY B, LIGHT GRAY, W/O CPA	33472-0852	B-LG	GCP	PLR		M	RG	1	2	3	4	5	6	7	8	PLANNED OBSOLESCENCE		34951-0810	34951-0820	
KEY C, BROWN, W/O CPA	33472-0853	C-BR	GCP	PLR		M	RG	1	2	3	4	5	6	7	8	PLANNED OBSOLESCENCE		34951-0810	34951-0820	
KEY D, GREEN, W/O CPA	33472-0854	D-GR	GCP	PLR		M	RG	1	2	3	4	5	6	7	8	PLANNED OBSOLESCENCE		34951-0810	34951-0820	
KEY D, BLACK, W/O CPA	33472-0855	D-BLK	GCP	PLR		M	RG	1	2	3	4	5	6	7	8	PLANNED OBSOLESCENCE		34951-0810	34951-0820	
KEY A, BLACK, W/CPA	33472-0856	A-BLK	GCP	PLR	CPA	M	RG		2				6	7		PLANNED OBSOLESCENCE		34951-0810	34951-0820	
KEY A, BLACK, W/CPA	33472-0857	A-BLK	GCP	PLR	CPA	M	RG	1	2			5	6	7		PLANNED OBSOLESCENCE		34951-0810	34951-0820	
KEY A, BLACK, W/CPA	33472-0858	A-BLK	GCP	PLR	CPA	M	RG	1	2	3		5	6	7		PLANNED OBSOLESCENCE		34951-0810	34951-0820	
KEY A, BLACK, W/O CPA	33472-0859	A-BLK	GCP	PLR		M	RG	1	2	3			6	7	8	PLANNED OBSOLESCENCE		34951-0810	34951-0820	
KEY D, BLACK, W/O CPA	33472-0860	D-BLK	GCP	PLR		M	RG				4					PLANNED OBSOLESCENCE		34951-0810	34951-0820	
KEY A, BLACK, W/O CPA	33472-0861	A-BLK	GCP	PLR		M	RG								8	PLANNED OBSOLESCENCE		34951-0810	34951-0820	
KEY A, BLACK, W/O CPA	33472-0862	A-BLK	GCP	PLR		M	RG	1								PLANNED OBSOLESCENCE		34951-0810	34951-0820	
KEY A, BLACK, W/O CPA	33472-0863	A-BLK	GCP	PLR		M	RG		2	3		5			8	PLANNED OBSOLESCENCE		34951-0810	34951-0820	
KEY A, BLACK, W/O CPA	33472-0864	A-BLK	GCP	PLR		M	RG	1		3		5				PLANNED OBSOLESCENCE		34951-0810	34951-0820	
KEY A, BLACK, W/O CPA	33472-0865	A-BLK	GCP	PLR		M	RG	1					6			PLANNED OBSOLESCENCE		34951-0810	34951-0820	
KEY A, BLACK, W/O CPA	33472-0866	A-BLK	GCP	PLR		M	RG		2	3		5	6		8	PLANNED OBSOLESCENCE		34951-0810	34951-0820	
KEY A, BLACK, W/O CPA	33472-0867	A-BLK	GCP	PLR		M	RG	1		3		5	6			PLANNED OBSOLESCENCE		34951-0810	34951-0820	
KEY A, BLACK, W/O CPA	33472-0868	A-BLK	GCP	PLR		M	RG					5	6		8	PLANNED OBSOLESCENCE		34951-0810	34951-0820	
KEY A, BLACK, W/O CPA	33472-0869	A-BLK	GCP	PLR		M	RG						6			PLANNED OBSOLESCENCE		34951-0810	34951-0820	
KEY A, BLACK, W/O CPA	33472-0870	A-BLK	GCP	PLR		M	RG	1		3		5	6	7	8	PLANNED OBSOLESCENCE		34951-0810	34951-0820	
KEY A, BLACK, W/O CPA	33472-0871	A-BLK	GCP	PLR		M	RG		2	3	4	5	6	7		PLANNED OBSOLESCENCE		34951-0810	34951-0820	
KEY A, BLACK, W/O CPA	33472-0872	A-BLK	GCP	PLR		M	RG							7	8	PLANNED OBSOLESCENCE		34951-0810	34951-0820	
KEY A, BLACK, W/O CPA	33472-0873	A-BLK	GCP	PLR		M	RG		2	3			6	7	8	PLANNED OBSOLESCENCE		34951-0810	34951-0820	
KEY A, BLACK, W/O CPA	33472-0874	A-BLK	GCP	PLR		M	RG		2	3						PLANNED OBSOLESCENCE		34951-0810	34951-0820	
KEY A, BLACK, W/O CPA	33472-0875	A-BLK	GCP	PLR		M	RG	1			4					PLANNED OBSOLESCENCE		34951-0810	34951-0820	
KEY A, BLACK, W/O CPA	33472-0876	A-BLK	GCP	PLR		M	RG		2	3		5	6	7	8	PLANNED OBSOLESCENCE		34951-0810	34951-0820	
KEY A, BLACK, W/CPA	33472-0877	A-BLK	GCP	PLR	CPA	M	RG								8	PLANNED OBSOLESCENCE		34951-0810	34951-0820	
KEY A, BLACK, W/O CPA	33472-0878	A-BLK	GCP	PLR		M	RG			3		5	6			PLANNED OBSOLESCENCE		34951-0810	34951-0820	
KEY C, DARK GRAY, W/O CPA	33472-0879	C-DG	GCO	PLR		M	RG									PLANNED OBSOLESCENCE		34951-0810	34951-0820	
KEY D, STONE GRAY, W/O CPA	33472-0880	D-SG	GCO	PLR		M	RG									PLANNED OBSOLESCENCE		34951-0810	34951-0820	
KEY C, DARK GRAY, W/CPA	33472-0881	C-DG	GCO	PLR	CPA	M	RG									PLANNED OBSOLESCENCE		34951-0810	34951-0820	
KEY D, STONE GRAY, W/CPA	33472-0882	D-SG	GCO	PLR	CPA	M	RG									PLANNED OBSOLESCENCE		34951-0810	34951-0820	
KEY A, BLACK, W/O CPA	33472-0883	A-BLK	GCP	PLR		M	RG		2	3	4	5		7	8	PLANNED OBSOLESCENCE		34951-0810	34951-0820	
KEY A, BLACK, W/O CPA	33472-0884	A-BLK	GCP	PLR		M	RG			3			6	7		PLANNED OBSOLESCENCE		34951-0810	34951-0820	
KEY A, BLACK, W/O CPA	33472-0885	A-BLK	GCP	PLR		M	RG		2	3	4	5	6		8	PLANNED OBSOLESCENCE		34951-0810	34951-0820	
KEY A, BLACK, W/O CPA	33472-0886	A-BLK	GCP	PLR		M	RG			3			6		8	PLANNED OBSOLESCENCE		34951-0810	34951-0820	
KEY B, LIGHT GRAY, W/CPA	33472-0887	B-LG	GCP	PLR	CPA	M	RG								8	PLANNED OBSOLESCENCE		34951-0810	34951-0820	
KEY B, LIGHT GRAY, W/O CPA	33472-0888	B-LG	GCP	PLR		M	RG	1					6			PLANNED OBSOLESCENCE		34951-0810	34951-0820	
KEY A, BLACK, W/O CPA	33472-0889	A-BLK	GCP	PLR		M	RG	1				5				PLANNED OBSOLESCENCE		34951-0810	34951-0820	
KEY A, YELLOW, W/CPA	33472-0890	A-YW	GCP	PLR	CPA	M	RG		2	3						PLANNED OBSOLESCENCE		34951-0810	34951-0820	
KEY A, YELLOW, W/CPA	33472-0891	A-YW	GCO	PLR	CPA	M	RG									PLANNED OBSOLESCENCE		34951-0810	34951-0820	
KEY A, YELLOW, W/O CPA	33472-0892	A-YW	GCO	PLR		M	RG									PLANNED OBSOLESCENCE		34951-0810	34951-0820	
KEY A, BLACK, W/CPA	33472-0893	A-BLK	GCP	PLR	CPA	M	RG						6			PLANNED OBSOLESCENCE		34951-0810	34951-0820	
KEY A, BLACK, W/CPA	33472-0894	A-BLK	GCP	PLR	CPA	M	RG	1	2	3			6	7	8	PLANNED OBSOLESCENCE		34951-0810	34951-0820	
KEY A, BLACK, W/O CPA	33472-0895	A-BLK	GCP	PLR		M	RG	1	2							PLANNED OBSOLESCENCE		34951-0810	34951-0820	
KEY A, BLACK, W/O CPA	33472-1001	A-BLK	GCP	PLR		M	RG	1	2	3	4					PLANNED OBSOLESCENCE		34951-0810	34951-0820	
KEY B, LIGHT GRAY, W/O CPA	33472-1002	B-LG	GCP	PLR		M	RG						6			PLANNED OBSOLESCENCE		34951-0810	34951-0820	
KEY A, BLACK, W/O CPA	33472-1003	A-BLK	GCP	PLR		M	RG	1			4					PLANNED OBSOLESCENCE		34951-0810	34951-0820	
KEY A, BLACK, W/O CPA	33472-1004	A-BLK	GCP	PLR		M	RG		2	3		5	6	7	8	PLANNED OBSOLESCENCE		34951-0810	34951-0820	
KEY A, BLACK, W/CPA	33472-1005	A-BLK	GCP	PLR	CPA	M	RG								8	PLANNED OBSOLESCENCE		34951-0810	34951-0820	
KEY A, BLACK, W/O CPA	33472-1006	A-BLK	GCP	PLR		M	RG	1	2	3	4	5	6			PLANNED OBSOLESCENCE		34951-0810	34951-0820	
KEY A, BLACK, W/CPA	33472-1007	A-BLK	GCP	PLR	CPA	M	RG						6	7		PLANNED OBSOLESCENCE		34951-0810	34951-0820	
KEY A, BLACK, W/CPA	33472-1008	A-BLK	GCP	PLR	CPA	M	RG							7		PLANNED OBSOLESCENCE		34951-0810	34951-0820	
KEY D, STONE GRAY, W/CPA	33472-1009	D-SG	GCP	PLR	CPA	M	RG				4					PLANNED OBSOLESCENCE		34951-0810	34951-0820	
KEY D, STONE GRAY, W/CPA	33472-1010	D-SG	GCP	PLR	CPA	M	RG				4	5				PLANNED OBSOLESCENCE		34951-0810	34951-0820	
KEY D, STONE GRAY, W/CPA	33472-1011	D-SG	GCP	PLR	CPA	M	RG				4	5	6			PLANNED OBSOLESCENCE		34951-0810	34951-0820	
KEY A, BLACK, W/O CPA	33472-1012	A-BLK	GCP	PLR		M	RG							7	8	PLANNED OBSOLESCENCE		34951-0810	34951-0820	
KEY A, BLACK, W/CPA	33472-1013	A-BLK	GCP	PLR	CPA	M	RG			3	4	5	6	7	8	PLANNED OBSOLESCENCE		34951-0810	34951-0820	
KEY A, BLACK, W/O CPA	33472-1014	A-BLK	GCP	PLR		M	RG			3	4	5	6	7	8	PLANNED OBSOLESCENCE		34951-0810	34951-0820	
KEY A, BLACK, W/CPA	33472-1015	A-BLK	GCP	PLR	CPA	M	RG				4			7	8	PLANNED OBSOLESCENCE		34951-0810	34951-0820	
KEY A, BLACK, W/O CPA	33472-1016	A-BLK	GCP	PLR		M	RG						6	7	8	PLANNED OBSOLESCENCE		34951-0810	34951-0820	
KEY A, BLACK, W/O CPA	33472-1017	A-BLK	GCP	PLR		M	RG	1							8	PLANNED OBSOLESCENCE		34951-0810	34951-0820	
KEY A, BLACK, W/CPA	33472-1018	A-BLK	GCP	PLR	CPA	M	RG			3	4		5	6	7	8	PLANNED OBSOLESCENCE		34951-0810	34951-0820
KEY A, BLACK, W/CPA	33472-1019	A-BLK	GCP	PLR	CPA	M	RG							7	8	PLANNED OBSOLESCENCE		34951-0810	34951-0820	
KEY A, BLACK, W/CPA	33472-1020	A-BLK	GCP	PLR	CPA	M	RG		2	3	4		6	7	8	PLANNED OBSOLESCENCE		34951-0810	34951-0820	
KEY A, BLACK, W/CPA	33472-1021	A-BLK	GCP	PLR	CPA	M	RG	1	2	3	4		5	6	7	8	PLANNED OBSOLESCENCE		34951-0810	34951-0820
KEY A, BLACK, W/CPA	33472-1022	A-BLK	GCP	PLR	CPA	M	RG	1					5			PLANNED OBSOLESCENCE		34951-0810	34951-0820	
KEY A, BLACK, W/O CPA	33472-1023	A-BLK	GCP	PLR		M	RG						5	6	7	8	PLANNED OBSOLESCENCE		34951-0810	34951-0820
KEY A, BLACK, W/O CPA	33472-1024	A-BLK	GCP	PLR		M	RG				3	4				PLANNED OBSOLESCENCE		34951-0810	34951-0820	

MX150 RECEPTACLE 2X4 SEALED ASSEMBLY MAT SEAL  
BOM AND PIN OUT SHEET

ASSEMBLY DESCRIPTION	ASSEMBLY PART NUMBER	COMPONENT						BLOCKED TERMINALS								STATUS	COMMENTS	OPTIONAL ATTACHMENTS SOLD SEPERATELY		
		THE PRESENCE OF AN ABBREVIATION INDICATES THE PRESENCE OF THAT COMPONENT.						CAVITY WITH A NUMBER INDICATES BLOCKED TERMINAL POSITION CAVITY WITHOUT A NUMBER INDICATES OPEN TERMINAL POSITION										BACKSHELL WITH RIBS	BACKSHELL WITHOUT RIBS	
		HOUSING KEY/COLOR	GROMMET CAP	PLR	CPA	MAT SEAL	RING SEAL	1	2	3	4	5	6	7	8					
KEY D, STONE GRAY, W/O CPA	33472-1025	D-SG	GCP	PLR		M	RG					4	5	6			PLANNED OBSOLESCENCE		34951-0810	34951-0820
KEY D, STONE GRAY, W/O CPA	33472-1026	D-SG	GCP	PLR		M	RG					4					PLANNED OBSOLESCENCE		34951-0810	34951-0820
KEY B, LIGHT GRAY, W/O CPA	33472-1027	B-LG	GCP	PLR		M	RG								7	8	PLANNED OBSOLESCENCE		34951-0810	34951-0820
KEY A, BLACK, W/O CPA	33472-1028	A-BLK	GCP	PLR		M	RG	1	2	3	4				7	8	PLANNED OBSOLESCENCE		34951-0810	34951-0820
KEY A, BLACK, W/O CPA	33472-1029	A-BLK	GCP	PLR		M	RG			3	4					8	PLANNED OBSOLESCENCE		34951-0810	34951-0820
KEY A, BLACK, W/O CPA	33472-1030	A-BLK	GCP	PLR		M	RG	1	2	3	4	5			7		PLANNED OBSOLESCENCE		34951-0810	34951-0820
KEY A, BLACK, W/O CPA	33472-1031	A-BLK	GCP	PLR		M	RG					5					PLANNED OBSOLESCENCE		34951-0810	34951-0820
KEY A, BLACK, W/O CPA	33472-1032	A-BLK	GCP	PLR		M	RG		2			5					PLANNED OBSOLESCENCE		34951-0810	34951-0820
KEY B, LIGHT GRAY, W/O CPA	33472-1033	B-LG	GCP	PLR		M	RG	1		3						8	PLANNED OBSOLESCENCE		34951-0810	34951-0820
KEY B, LIGHT GRAY, W/O CPA	33472-1034	B-LG	GCP	PLR		M	RG			3						8	PLANNED OBSOLESCENCE		34951-0810	34951-0820
KEY B, LIGHT GRAY, W/O CPA	33472-1035	B-LG	GCP	PLR		M	RG	1									PLANNED OBSOLESCENCE		34951-0810	34951-0820
KEY A, BLACK, W/O CPA	33472-1036	A-BLK	GCP	PLR		M	RG	1								8	PLANNED OBSOLESCENCE		34951-0810	34951-0820
KEY A, BLACK, W/O CPA	33472-1037	A-BLK	GCP	PLR		M	RG						6			8	PLANNED OBSOLESCENCE		34951-0810	34951-0820
KEY A, BLACK, W/O CPA	33472-1038	A-BLK	GCP	PLR		M	RG	1			4	5	6		7	8	PLANNED OBSOLESCENCE		34951-0810	34951-0820
KEY A, BLACK, W/O CPA	33472-1039	A-BLK	GCP	PLR		M	RG		2						7		PLANNED OBSOLESCENCE		34951-0810	34951-0820
KEY B, LIGHT GRAY, W/O CPA	33472-1040	B-LG	GCP	PLR		M	RG					5			7		PLANNED OBSOLESCENCE		34951-0810	34951-0820
KEY A, BLACK, W/O CPA	33472-1041	A-BLK	GCP	PLR		M	RG				4	5	6		7	8	PLANNED OBSOLESCENCE		34951-0810	34951-0820
KEY A, BLACK, W/O CPA	33472-1042	A-BLK	GCP	PLR		M	RG					5				8	PLANNED OBSOLESCENCE		34951-0810	34951-0820
KEY A, BLACK, W/O CPA	33472-1043	A-BLK	GCP	PLR		M	RG		2		4	5	6				PLANNED OBSOLESCENCE		34951-0810	34951-0820
KEY A, BLACK, W/O CPA	33472-1044	A-BLK	GCP	PLR		M	RG	1	2	3	4		6	7			PLANNED OBSOLESCENCE		34951-0810	34951-0820
KEY A, BLACK, W/O CPA	33472-1045	A-BLK	GCP	PLR		M	RG				4		6				PLANNED OBSOLESCENCE		34951-0810	34951-0820
KEY A, BLACK, W/CPA	33472-1046	A-BLK	GCP	PLR	CPA	M	RG	1							7		PLANNED OBSOLESCENCE		34951-0810	34951-0820
KEY B, LIGHT GRAY, W/O CPA	33472-1047	B-LG	GCP	PLR		M	RG					5					PLANNED OBSOLESCENCE		34951-0810	34951-0820
KEY A, BLACK, W/O CPA	33472-1048	A-BLK	GCP	PLR		M	RG	1	2				5	6		8	PLANNED OBSOLESCENCE		34951-0810	34951-0820
KEY A, BLACK, W/O CPA	33472-1049	A-BLK	GCP	PLR		M	RG	1	2							8	PLANNED OBSOLESCENCE		34951-0810	34951-0820
KEY A, BLACK, W/O CPA	33472-1050	A-BLK	GCP	PLR		M	RG				4	5	6				PLANNED OBSOLESCENCE		34951-0810	34951-0820
KEY A, BLACK, W/O CPA	33472-1051	A-BLK	GCP	PLR		M	RG	1	2	3			6				PLANNED OBSOLESCENCE		34951-0810	34951-0820
KEY A, BLACK, W/O CPA	33472-1052	A-BLK	GCP	PLR		M	RG				4	5		7	8		PLANNED OBSOLESCENCE		34951-0810	34951-0820
KEY A, BLACK, W/O CPA	33472-1053	A-BLK	GCP	PLR		M	RG			3	4				7	8	PLANNED OBSOLESCENCE		34951-0810	34951-0820
KEY A, BLACK, WITH CLIPSLOT, W/O CPA	33472-0901	A-BLK-CLIP	GCO	PLR		M	RG										PLANNED OBSOLESCENCE			
KEY B, LIGHT GRAY, WITH CLIPSLOT, W/O CPA	33472-0902	B-LG-CLIP	GCO	PLR		M	RG										PLANNED OBSOLESCENCE			
KEY C, BROWN, WITH CLIPSLOT, W/O CPA	33472-0903	C-BR-CLIP	GCO	PLR		M	RG										PLANNED OBSOLESCENCE	SEE P/N 33472-0922		
KEY D, GREEN, WITH CLIPSLOT, W/O CPA	33472-0904	D-GR-CLIP	GCO	PLR		M	RG										PLANNED OBSOLESCENCE	SEE P/N 33472-0923		
KEY D, BLACK, WITH CLIPSLOT, W/O CPA	33472-0905	D-BLK-CLIP	GCO	PLR		M	RG										PLANNED OBSOLESCENCE			
KEY A, BLACK, WITH CLIPSLOT, W/CPA	33472-0906	A-BLK-CLIP	GCO	PLR	CPA	M	RG										PLANNED OBSOLESCENCE			
KEY B, LIGHT GRAY, WITH CLIPSLOT, W/CPA	33472-0907	B-LG-CLIP	GCO	PLR	CPA	M	RG										PLANNED OBSOLESCENCE			
KEY C, BROWN, WITH CLIPSLOT, W/CPA	33472-0908	C-BR-CLIP	GCO	PLR	CPA	M	RG										PLANNED OBSOLESCENCE	SEE P/N 33472-0924		
KEY D, GREEN, WITH CLIPSLOT, W/CPA	33472-0909	D-GR-CLIP	GCO	PLR	CPA	M	RG										PLANNED OBSOLESCENCE	SEE P/N 33472-0925		
KEY A, BLACK, WITH CLIPSLOT, W/O CPA	33472-0910	A-BLK-CLIP	GCP	PLR		M	RG				4						PLANNED OBSOLESCENCE			
KEY A, BLACK, WITH CLIPSLOT, W/O CPA	33472-0920	A-BLK-CLIP	GCP	PLR		M	RG				4					8	PLANNED OBSOLESCENCE			
KEY A, BLACK, WITH CLIPSLOT, W/O CPA	33472-0921	A-BLK-CLIP	GCP	PLR		M	RG									8	PLANNED OBSOLESCENCE			
KEY C, DARK GRAY, WITH CLIPSLOT, W/O CPA	33472-0922	C-DG-CLIP	GCO	PLR		M	RG										PLANNED OBSOLESCENCE			
KEY D, STONE GRAY, WITH CLIPSLOT, W/O CPA	33472-0923	D-SG-CLIP	GCO	PLR		M	RG										PLANNED OBSOLESCENCE			
KEY C, DARK GRAY, WITH CLIPSLOT, W/CPA	33472-0924	C-DG-CLIP	GCO	PLR	CPA	M	RG										PLANNED OBSOLESCENCE			
KEY D, STONE GRAY, WITH CLIPSLOT, W/CPA	33472-0925	D-SG-CLIP	GCO	PLR	CPA	M	RG										PLANNED OBSOLESCENCE			
KEY B, LIGHT GRAY, WITH CLIPSLOT, W/O CPA	33472-0926	B-LG-CLIP	GCP	PLR		M	RG				4					8	PLANNED OBSOLESCENCE			
KEY A, BLACK, WITH CLIPSLOT, W/CPA	33472-0927	A-BLK-CLIP	GCP	PLR	CPA	M	RG				4					8	PLANNED OBSOLESCENCE			
KEY B, LIGHT GRAY, WITH CLIPSLOT, W/CPA	33472-0928	B-LG-CLIP	GCP	PLR	CPA	M	RG				4					8	PLANNED OBSOLESCENCE			
KEY A, BLACK, WITH CLIPSLOT, W/O CPA	33472-0929	A-BLK-CLIP	GCP	PLR		M	RG				4	5		7	8		PLANNED OBSOLESCENCE			
KEY A, BLACK, WITH CLIPSLOT, W/O CPA	33472-0930	A-BLK-CLIP	GCP	PLR		M	RG			2	3	4	5		7	8	PLANNED OBSOLESCENCE			
KEY A, BLACK, WITH CLIPSLOT, W/O CPA	33472-0931	A-BLK-CLIP	GCP	PLR		M	RG	1	2	3				6			PLANNED OBSOLESCENCE			
KEY A, BLACK, WITH CLIPSLOT, W/O CPA	33472-0932	A-BLK-CLIP	GCP	PLR		M	RG	1						6			PLANNED OBSOLESCENCE			
KEY A, BLACK, WITH CLIPSLOT, W/CPA	33472-0933	A-BLK-CLIP	GCP	PLR	CPA	M	RG									8	PLANNED OBSOLESCENCE			
KEY B, LIGHT GRAY, WITH CLIPSLOT, W/CPA	33472-0934	B-LG-CLIP	GCP	PLR	CPA	M	RG									8	PLANNED OBSOLESCENCE			
KEY A, BLACK, WITH CLIPSLOT, W/CPA	33472-0935	A-BLK-CLIP	GCP	PLR	CPA	M	RG		2	3	4			6	7	8	PLANNED OBSOLESCENCE			
KEY A, BLACK, WITH CLIPSLOT, W/O CPA	33472-0936	A-BLK-CLIP	GCP	PLR		M	RG							6	7	8	PLANNED OBSOLESCENCE			
KEY A, BLACK, WITH CLIPSLOT, W/O CPA	33472-0937	A-BLK-CLIP	GCP	PLR		M	RG					5				8	PLANNED OBSOLESCENCE			
KEY A, BLACK, WITH CLIPSLOT, W/O CPA	33472-0938	A-BLK-CLIP	GCP	PLR		M	RG					5					PLANNED OBSOLESCENCE			
KEY A, BLACK, WITH CLIPSLOT, W/O CPA	33472-0939	A-BLK-CLIP	GCP	PLR		M	RG				4	5	6	7	8		PLANNED OBSOLESCENCE			
KEY A, BLACK, WITH CLIPSLOT, W/O CPA	33472-0940	A-BLK-CLIP	GCP	PLR		M	RG	1	2			5	6				PLANNED OBSOLESCENCE			
KEY A, BLACK, WITH CLIPSLOT, W/O CPA	33472-0941	A-BLK-CLIP	GCP	PLR		M	RG	1	2	3	4	5	6				PLANNED OBSOLESCENCE			
KEY A, BLACK, W/O CPA	33472-4801	A-BLK	GCO	PLR		M	RR										SALEABLE		34951-0810	34951-0820
KEY B, LIGHT GRAY, W/O CPA	33472-4802	B-LG	GCO	PLR		M	RR										SALEABLE		34951-0810	34951-0820
KEY C, BROWN, W/O CPA	33472-4803	C-BR	GCO	PLR		M	RR										NOT RECOMMENDED	SEE P/N 33472-4879	34951-0810	34951-0820
KEY D, GREEN, W/O CPA	33472-4804	D-GR	GCO	PLR		M	RR										NOT RECOMMENDED	SEE P/N 33472-4880	34951-0810	34951-0820
KEY D, BLACK, W/O CPA	33472-4805	D-BLK	GCO	PLR		M	RR										SALEABLE		34951-0810	34951-0820
KEY A, BLACK, W/CPA	33472-4806	A-BLK	GCO	PLR	CPA	M	RR										SALEABLE		34951-0810	34951-0820
KEY B, LIGHT GRAY, W/CPA	33472-4807	B-LG	GCO	PLR	CPA	M	RR										SALEABLE		34951-0810	34951-0820
KEY C, BROWN, W/CPA	33472-4808	C-BR	GCO	PLR	CPA	M	RR										NOT RECOMMENDED	SEE P/N 33472-4881	34951-0810	34951-0820
KEY D, GREEN, W/CPA	33472-4809	D-GR	GCO	PLR	CPA	M	RR										NOT RECOMMENDED	SEE P/N 33472-4882	34951-0810	34951-0820
VOID KEY	33472-4810																			
KEY A, BLACK, W/O CPA	33472-4811	A-BLK	GCP	PLR		M	RR				4						SALEABLE		34951-0810	34951-0820
KEY B, LIGHT GRAY, W/O CPA	33472-4812	B-LG	GCP	PLR		M	RR				4						SALEABLE		34951-0810	34951-0820
KEY C, BROWN, W/O CPA	33472-4813	C-BR	GCP	PLR		M	RR				4						NOT RECOMMENDED		34951-0810	34951-0820
KEY D, GREEN, W/O CPA	33472-4814	D-GR	GCP	PLR		M	RR				4						NOT RECOMMENDED		34951-0810	34951-0820



MX150 RECEPTACLE 2X4 SEALED ASSEMBLY MAT SEAL  
BOM AND PIN OUT SHEET

ASSEMBLY DESCRIPTION	ASSEMBLY PART NUMBER	COMPONENT						BLOCKED TERMINALS								STATUS	COMMENTS	OPTIONAL ATTACHMENTS SOLD SEPERATELY		
		THE PRESENCE OF AN ABBREVIATION INDICATES THE PRESENCE OF THAT COMPONENT.						CAVITY WITH A NUMBER INDICATES BLOCKED TERMINAL POSITION CAVITY WITHOUT A NUMBER INDICATES OPEN TERMINAL POSITION										BACKSHELL WITH RIBS	BACKSHELL WITHOUT RIBS	
		HOUSING KEY/COLOR	GROMMET CAP	PLR	CPA	MAT SEAL	RING SEAL	1	2	3	4	5	6	7	8					
VOID KEY	33472-4815																			
KEY A, BLACK, W/CPA	33472-4816	A-BLK	GCP	PLR	CPA	M	RR				4						SALEABLE		34951-0810	34951-0820
KEY B, LIGHT GRAY, W/CPA	33472-4817	B-LG	GCP	PLR	CPA	M	RR				4						SALEABLE		34951-0810	34951-0820
KEY C, BROWN, W/CPA	33472-4818	C-BR	GCP	PLR	CPA	M	RR				4						NOT RECOMMENDED		34951-0810	34951-0820
KEY D, GREEN, W/CPA	33472-4819	D-GR	GCP	PLR	CPA	M	RR				4						NOT RECOMMENDED	SEE P/N 33472-5009	34951-0810	34951-0820
VOID KEY	33472-4820																			
KEY A, BLACK, W/O CPA	33472-4821	A-BLK	GCP	PLR		M	RR				4	5					SALEABLE		34951-0810	34951-0820
KEY B, LIGHT GRAY, W/O CPA	33472-4822	B-LG	GCP	PLR		M	RR				4	5					SALEABLE		34951-0810	34951-0820
KEY C, BROWN, W/O CPA	33472-4823	C-BR	GCP	PLR		M	RR				4	5					NOT RECOMMENDED		34951-0810	34951-0820
KEY D, GREEN, W/O CPA	33472-4824	D-GR	GCP	PLR		M	RR				4	5					NOT RECOMMENDED		34951-0810	34951-0820
VOID KEY	33472-4825																			
KEY A, BLACK, W/CPA	33472-4826	A-BLK	GCP	PLR	CPA	M	RR				4	5					SALEABLE		34951-0810	34951-0820
KEY B, LIGHT GRAY, W/CPA	33472-4827	B-LG	GCP	PLR	CPA	M	RR				4	5					SALEABLE		34951-0810	34951-0820
KEY C, BROWN, W/CPA	33472-4828	C-BR	GCP	PLR	CPA	M	RR				4	5					NOT RECOMMENDED		34951-0810	34951-0820
KEY D, GREEN, W/CPA	33472-4829	D-GR	GCP	PLR	CPA	M	RR				4	5					NOT RECOMMENDED	SEE P/N 33472-5010	34951-0810	34951-0820
VOID KEY	33472-4830																			
KEY A, BLACK, W/O CPA	33472-4831	A-BLK	GCP	PLR		M	RR	1			4	5					SALEABLE		34951-0810	34951-0820
KEY B, LIGHT GRAY, W/O CPA	33472-4832	B-LG	GCP	PLR		M	RR	1			4	5					SALEABLE		34951-0810	34951-0820
KEY C, BROWN, W/O CPA	33472-4833	C-BR	GCP	PLR		M	RR	1			4	5					NOT RECOMMENDED		34951-0810	34951-0820
KEY D, GREEN, W/O CPA	33472-4834	D-GR	GCP	PLR		M	RR	1			4	5					NOT RECOMMENDED		34951-0810	34951-0820
VOID KEY	33472-4835																			
KEY A, BLACK, W/CPA	33472-4836	A-BLK	GCP	PLR	CPA	M	RR	1			4	5					SALEABLE		34951-0810	34951-0820
KEY B, LIGHT GRAY, W/CPA	33472-4837	B-LG	GCP	PLR	CPA	M	RR	1			4	5					SALEABLE		34951-0810	34951-0820
KEY C, BROWN, W/CPA	33472-4838	C-BR	GCP	PLR	CPA	M	RR	1			4	5					NOT RECOMMENDED		34951-0810	34951-0820
KEY D, GREEN, W/CPA	33472-4839	D-GR	GCP	PLR	CPA	M	RR	1			4	5					NOT RECOMMENDED		34951-0810	34951-0820
VOID KEY	33472-4840																			
KEY A, BLACK, W/O CPA	33472-4841	A-BLK	GCP	PLR		M	RR	1			4	5				8	SALEABLE		34951-0810	34951-0820
KEY B, LIGHT GRAY, W/O CPA	33472-4842	B-LG	GCP	PLR		M	RR	1			4	5				8	SALEABLE		34951-0810	34951-0820
KEY C, BROWN, W/O CPA	33472-4843	C-BR	GCP	PLR		M	RR	1			4	5				8	NOT RECOMMENDED		34951-0810	34951-0820
KEY D, GREEN, W/O CPA	33472-4844	D-GR	GCP	PLR		M	RR	1			4	5				8	NOT RECOMMENDED		34951-0810	34951-0820
VOID KEY	33472-4845																			
KEY A, BLACK, W/CPA	33472-4846	A-BLK	GCP	PLR	CPA	M	RR	1			4	5				8	SALEABLE		34951-0810	34951-0820
KEY B, LIGHT GRAY, W/CPA	33472-4847	B-LG	GCP	PLR	CPA	M	RR	1			4	5				8	SALEABLE		34951-0810	34951-0820
KEY C, BROWN, W/CPA	33472-4848	C-BR	GCP	PLR	CPA	M	RR	1			4	5				8	NOT RECOMMENDED		34951-0810	34951-0820
KEY D, GREEN, W/CPA	33472-4849	D-GR	GCP	PLR	CPA	M	RR	1			4	5				8	NOT RECOMMENDED		34951-0810	34951-0820
VOID KEY	33472-4850																			
KEY A, BLACK, W/O CPA	33472-4851	A-BLK	GCP	PLR		M	RR	1	2	3	4	5	6	7	8		SALEABLE		34951-0810	34951-0820
KEY B, LIGHT GRAY, W/O CPA	33472-4852	B-LG	GCP	PLR		M	RR	1	2	3	4	5	6	7	8		SALEABLE		34951-0810	34951-0820
KEY C, BROWN, W/O CPA	33472-4853	C-BR	GCP	PLR		M	RR	1	2	3	4	5	6	7	8		NOT RECOMMENDED		34951-0810	34951-0820
KEY D, GREEN, W/O CPA	33472-4854	D-GR	GCP	PLR		M	RR	1	2	3	4	5	6	7	8		NOT RECOMMENDED		34951-0810	34951-0820
KEY A, BLACK, W/O CPA	33472-4855	D-BLK	GCP	PLR		M	RR	1	2	3	4	5	6	7	8		SALEABLE		34951-0810	34951-0820
KEY A, BLACK, W/CPA	33472-4856	A-BLK	GCP	PLR	CPA	M	RR		2				6	7			SALEABLE		34951-0810	34951-0820
KEY A, BLACK, W/CPA	33472-4857	A-BLK	GCP	PLR	CPA	M	RR	1	2			5	6	7			SALEABLE		34951-0810	34951-0820
KEY A, BLACK, W/CPA	33472-4858	A-BLK	GCP	PLR	CPA	M	RR	1	2	3		5	6	7			SALEABLE		34951-0810	34951-0820
KEY A, BLACK, W/O CPA	33472-4859	A-BLK	GCP	PLR		M	RR	1	2	3			6	7	8		SALEABLE		34951-0810	34951-0820
KEY D, BLACK, W/O CPA	33472-4860	D-BLK	GCP	PLR		M	RR				4						SALEABLE		34951-0810	34951-0820
KEY A, BLACK, W/O CPA	33472-4861	A-BLK	GCP	PLR		M	RR								8		SALEABLE		34951-0810	34951-0820
KEY A, BLACK, W/O CPA	33472-4862	A-BLK	GCP	PLR		M	RR	1									SALEABLE		34951-0810	34951-0820
KEY A, BLACK, W/O CPA	33472-4863	A-BLK	GCP	PLR		M	RR		2				5			8	SALEABLE		34951-0810	34951-0820
KEY A, BLACK, W/O CPA	33472-4864	A-BLK	GCP	PLR		M	RR	1		3			5				SALEABLE		34951-0810	34951-0820
KEY A, BLACK, W/O CPA	33472-4865	A-BLK	GCP	PLR		M	RR	1					6				SALEABLE		34951-0810	34951-0820
KEY A, BLACK, W/O CPA	33472-4866	A-BLK	GCP	PLR		M	RR			2			5	6		8	SALEABLE		34951-0810	34951-0820
KEY A, BLACK, W/O CPA	33472-4867	A-BLK	GCP	PLR		M	RR	1		3			5	6			SALEABLE		34951-0810	34951-0820
KEY A, BLACK, W/O CPA	33472-4868	A-BLK	GCP	PLR		M	RR						5	6		8	SALEABLE		34951-0810	34951-0820
KEY A, BLACK, W/O CPA	33472-4869	A-BLK	GCP	PLR		M	RR						6				SALEABLE		34951-0810	34951-0820
KEY A, BLACK, W/O CPA	33472-4870	A-BLK	GCP	PLR		M	RR	1			3		5	6	7	8	SALEABLE		34951-0810	34951-0820
KEY A, BLACK, W/O CPA	33472-4871	A-BLK	GCP	PLR		M	RR			2	3	4	5	6	7		SALEABLE		34951-0810	34951-0820
KEY A, BLACK, W/O CPA	33472-4872	A-BLK	GCP	PLR		M	RR							7	8		SALEABLE		34951-0810	34951-0820
KEY A, BLACK, W/O CPA	33472-4873	A-BLK	GCP	PLR		M	RR						6	7	8		SALEABLE		34951-0810	34951-0820
KEY A, BLACK, W/O CPA	33472-4874	A-BLK	GCP	PLR		M	RR			2	3						SALEABLE		34951-0810	34951-0820
KEY A, BLACK, W/O CPA	33472-4875	A-BLK	GCP	PLR		M	RR	1			4						SALEABLE		34951-0810	34951-0820
KEY A, BLACK, W/O CPA	33472-4876	A-BLK	GCP	PLR		M	RR			2	3		5	6	7	8	SALEABLE		34951-0810	34951-0820
KEY A, BLACK, W/CPA	33472-4877	A-BLK	GCP	PLR	CPA	M	RR								8		SALEABLE		34951-0810	34951-0820
KEY A, BLACK, W/O CPA	33472-4878	A-BLK	GCP	PLR		M	RR				3		5	6			SALEABLE		34951-0810	34951-0820
KEY C, DARK GRAY, W/O CPA	33472-4879	C-DG	GCO	PLR		M	RR										SALEABLE		34951-0810	34951-0820
KEY D, STONE GRAY, W/O CPA	33472-4880	D-SG	GCO	PLR		M	RR										SALEABLE		34951-0810	34951-0820
KEY C, DARK GRAY, W/CPA	33472-4881	C-DG	GCO	PLR	CPA	M	RR										SALEABLE		34951-0810	34951-0820
KEY D, STONE GRAY, W/CPA	33472-4882	D-SG	GCO	PLR	CPA	M	RR										SALEABLE		34951-0810	34951-0820
KEY A, BLACK, W/O CPA	33472-4883	A-BLK	GCP	PLR		M	RR		2	3	4	5			7	8	SALEABLE		34951-0810	34951-0820
KEY A, BLACK, W/O CPA	33472-4884	A-BLK	GCP	PLR		M	RR			3			6	7			SALEABLE		34951-0810	34951-0820
KEY A, BLACK, W/O CPA	33472-4885	A-BLK	GCP	PLR		M	RR			2	3	4	5	6		8	SALEABLE		34951-0810	34951-0820
KEY A, BLACK, W/O CPA	33472-4886	A-BLK	GCP	PLR		M	RR				3		6				SALEABLE		34951-0810	34951-0820
KEY B, LIGHT GRAY, W/CPA	33472-4887	B-LG	GCP	PLR	CPA	M	RR								8		SALEABLE		34951-0810	34951-0820
KEY B, LIGHT GRAY, W/O CPA	33472-4888	B-LG	GCP	PLR		M	RR	1						6			SALEABLE		34951-0810	34951-0820
KEY A, BLACK, W/O CPA	33472-4889	A-BLK	GCP	PLR		M	RR	1					5				SALEABLE		34951-0810	34951-0820

MX150 RECEPTACLE 2X4 SEALED ASSEMBLY MAT SEAL  
BOM AND PIN OUT SHEET

ASSEMBLY DESCRIPTION	ASSEMBLY PART NUMBER	COMPONENT						BLOCKED TERMINALS								STATUS	COMMENTS	OPTIONAL ATTACHMENTS SOLD SEPERATELY		
		THE PRESENCE OF AN ABBREVIATION INDICATES THE PRESENCE OF THAT COMPONENT.						CAVITY WITH A NUMBER INDICATES BLOCKED TERMINAL POSITION CAVITY WITHOUT A NUMBER INDICATES OPEN TERMINAL POSITION										BACKSHELL WITH RIBS	BACKSHELL WITHOUT RIBS	
		HOUSING KEY/COLOR	GROMMET CAP	PLR	CPA	MAT SEAL	RING SEAL	1	2	3	4	5	6	7	8					
KEY A, YELLOW, W/CPA	33472-4890	A-YW	GCP	PLR	CPA	M	RR		2	3							SALEABLE		34951-0810	34951-0820
KEY A, YELLOW, W/CPA	33472-4891	A-YW	GCO	PLR	CPA	M	RR										SALEABLE		34951-0810	34951-0820
KEY A, YELLOW, W/O CPA	33472-4892	A-YW	GCO	PLR		M	RR										SALEABLE		34951-0810	34951-0820
KEY A, BLACK, W/CPA	33472-4893	A-BLK	GCP	PLR	CPA	M	RR					6					SALEABLE		34951-0810	34951-0820
KEY A, BLACK, W/CPA	33472-4894	A-BLK	GCP	PLR	CPA	M	RR	1	2	3		6	7	8			SALEABLE		34951-0810	34951-0820
KEY A, BLACK, W/O CPA	33472-4895	A-BLK	GCP	PLR		M	RR	1	2								SALEABLE		34951-0810	34951-0820
KEY A, BLACK, W/O CPA	33472-5001	A-BLK	GCP	PLR		M	RR	1	2	3	4						SALEABLE		34951-0810	34951-0820
KEY B, LIGHT GRAY, W/O CPA	33472-5002	B-LG	GCP	PLR		M	RR					6					SALEABLE		34951-0810	34951-0820
KEY A, BLACK, W/O CPA	33472-5003	A-BLK	GCP	PLR		M	RR	1			4						SALEABLE		34951-0810	34951-0820
KEY A, BLACK, W/O CPA	33472-5004	A-BLK	GCP	PLR		M	RR		2	3		5	6	7	8		SALEABLE		34951-0810	34951-0820
KEY A, BLACK, W/CPA	33472-5005	A-BLK	GCP	PLR	CPA	M	RR								8		SALEABLE		34951-0810	34951-0820
KEY A, BLACK, W/O CPA	33472-5006	A-BLK	GCP	PLR		M	RR	1	2	3	4	5	6				SALEABLE		34951-0810	34951-0820
KEY A, BLACK, W/CPA	33472-5007	A-BLK	GCP	PLR	CPA	M	RR					6	7				SALEABLE		34951-0810	34951-0820
KEY A, BLACK, W/CPA	33472-5008	A-BLK	GCP	PLR	CPA	M	RR						7				SALEABLE		34951-0810	34951-0820
KEY D, STONE GRAY, W/CPA	33472-5009	D-SG	GCP	PLR	CPA	M	RR				4						SALEABLE		34951-0810	34951-0820
KEY D, STONE GRAY, W/CPA	33472-5010	D-SG	GCP	PLR	CPA	M	RR				4	5					SALEABLE		34951-0810	34951-0820
KEY D, STONE GRAY, W/CPA	33472-5011	D-SG	GCP	PLR	CPA	M	RR				4	5	6				SALEABLE		34951-0810	34951-0820
KEY A, BLACK, W/O CPA	33472-5012	A-BLK	GCP	PLR		M	RR				4			7	8		SALEABLE		34951-0810	34951-0820
KEY A, BLACK, W/CPA	33472-5013	A-BLK	GCP	PLR	CPA	M	RR			3	4	5	6	7	8		SALEABLE		34951-0810	34951-0820
KEY A, BLACK, W/O CPA	33472-5014	A-BLK	GCP	PLR		M	RR			3	4	5	6	7	8		SALEABLE		34951-0810	34951-0820
KEY A, BLACK, W/CPA	33472-5015	A-BLK	GCP	PLR	CPA	M	RR				4						SALEABLE		34951-0810	34951-0820
KEY A, BLACK, W/O CPA	33472-5016	A-BLK	GCP	PLR		M	RR						6	7	8		SALEABLE		34951-0810	34951-0820
KEY A, BLACK, W/O CPA	33472-5017	A-BLK	GCP	PLR		M	RR	1		3	4						SALEABLE		34951-0810	34951-0820
KEY A, BLACK, W/CPA	33472-5018	A-BLK	GCP	PLR	CPA	M	RR					5	6	7	8		SALEABLE		34951-0810	34951-0820
KEY A, BLACK, W/CPA	33472-5019	A-BLK	GCP	PLR	CPA	M	RR							7	8		SALEABLE		34951-0810	34951-0820
KEY A, BLACK, W/CPA	33472-5020	A-BLK	GCP	PLR	CPA	M	RR			2	3	4		6	7	8	SALEABLE		34951-0810	34951-0820
KEY A, BLACK, W/CPA	33472-5021	A-BLK	GCP	PLR	CPA	M	RR	1	2	3	4	5	6	7	8		SALEABLE		34951-0810	34951-0820
KEY A, BLACK, W/CPA	33472-5022	A-BLK	GCP	PLR	CPA	M	RR	1				5					SALEABLE		34951-0810	34951-0820
KEY A, BLACK, W/O CPA	33472-5023	A-BLK	GCP	PLR		M	RR					5	6	7	8		SALEABLE		34951-0810	34951-0820
KEY A, BLACK, W/O CPA	33472-5024	A-BLK	GCP	PLR		M	RR				3	4					SALEABLE		34951-0810	34951-0820
KEY D, STONE GRAY, W/O CPA	33472-5025	D-SG	GCP	PLR		M	RR					4	5	6			SALEABLE		34951-0810	34951-0820
KEY D, STONE GRAY, W/O CPA	33472-5026	D-SG	GCP	PLR		M	RR					4					SALEABLE		34951-0810	34951-0820
KEY B, LIGHT GRAY, W/O CPA	33472-5027	B-LG	GCP	PLR		M	RR							7	8		SALEABLE		34951-0810	34951-0820
KEY A, BLACK, W/O CPA	33472-5028	A-BLK	GCP	PLR		M	RR	1	2	3	4						SALEABLE		34951-0810	34951-0820
KEY A, BLACK, W/O CPA	33472-5029	A-BLK	GCP	PLR		M	RR				3	4					SALEABLE		34951-0810	34951-0820
KEY A, BLACK, W/O CPA	33472-5030	A-BLK	GCP	PLR		M	RR	1	2	3	4	5			7		SALEABLE		34951-0810	34951-0820
KEY A, BLACK, W/O CPA	33472-5031	A-BLK	GCP	PLR		M	RR					5					SALEABLE		34951-0810	34951-0820
KEY A, BLACK, W/O CPA	33472-5032	A-BLK	GCP	PLR		M	RR			2			5				SALEABLE		34951-0810	34951-0820
KEY B, LIGHT GRAY, W/O CPA	33472-5033	B-LG	GCP	PLR		M	RR	1			3					8	SALEABLE		34951-0810	34951-0820
KEY B, LIGHT GRAY, W/O CPA	33472-5034	B-LG	GCP	PLR		M	RR					3					SALEABLE		34951-0810	34951-0820
KEY B, LIGHT GRAY, W/O CPA	33472-5035	B-LG	GCP	PLR		M	RR	1									SALEABLE		34951-0810	34951-0820
KEY A, BLACK, W/O CPA	33472-5036	A-BLK	GCP	PLR		M	RR	1								8	SALEABLE		34951-0810	34951-0820
KEY A, BLACK, W/O CPA	33472-5037	A-BLK	GCP	PLR		M	RR						6				SALEABLE		34951-0810	34951-0820
KEY A, BLACK, W/O CPA	33472-5038	A-BLK	GCP	PLR		M	RR	1			4	5	6	7	8		SALEABLE		34951-0810	34951-0820
KEY A, BLACK, W/O CPA	33472-5039	A-BLK	GCP	PLR		M	RR		2						7		SALEABLE		34951-0810	34951-0820
KEY B, LIGHT GRAY, W/O CPA	33472-5040	B-LG	GCP	PLR		M	RR					5					SALEABLE		34951-0810	34951-0820
KEY A, BLACK, W/O CPA	33472-5041	A-BLK	GCP	PLR		M	RR				4	5	6	7	8		SALEABLE		34951-0810	34951-0820
KEY A, BLACK, W/O CPA	33472-5042	A-BLK	GCP	PLR		M	RR					5					SALEABLE		34951-0810	34951-0820
KEY A, BLACK, W/O CPA	33472-5043	A-BLK	GCP	PLR		M	RR			2		4	5	6			SALEABLE		34951-0810	34951-0820
KEY A, BLACK, W/O CPA	33472-5044	A-BLK	GCP	PLR		M	RR	1	2	3	4		6	7			SALEABLE		34951-0810	34951-0820
KEY A, BLACK, W/O CPA	33472-5045	A-BLK	GCP	PLR		M	RR					4					SALEABLE		34951-0810	34951-0820
KEY A, BLACK, W/CPA	33472-5046	A-BLK	GCP	PLR	CPA	M	RR	1							7		SALEABLE		34951-0810	34951-0820
KEY B, LIGHT GRAY, W/O CPA	33472-5047	B-LG	GCP	PLR		M	RR					5					SALEABLE		34951-0810	34951-0820
KEY A, BLACK, W/O CPA	33472-5048	A-BLK	GCP	PLR		M	RR	1	2				5	6			SALEABLE		34951-0810	34951-0820
KEY A, BLACK, W/O CPA	33472-5049	A-BLK	GCP	PLR		M	RR	1	2							8	SALEABLE		34951-0810	34951-0820
KEY A, BLACK, W/O CPA	33472-5050	A-BLK	GCP	PLR		M	RR				4	5	6				SALEABLE		34951-0810	34951-0820
KEY A, BLACK, W/O CPA	33472-5051	A-BLK	GCP	PLR		M	RR	1	2	3			6				SALEABLE		34951-0810	34951-0820
KEY A, BLACK, W/O CPA	33472-5052	A-BLK	GCP	PLR		M	RR					4	5		7	8	SALEABLE		34951-0810	34951-0820
KEY A, BLACK, W/O CPA	33472-5053	A-BLK	GCP	PLR		M	RR				3	4			7	8	SALEABLE		34951-0810	34951-0820
KEY A, BLACK, WITH CLIPSLOT, W/O CPA	33472-4901	A-BLK-CLIP	GCO	PLR		M	RR										SALEABLE			
KEY B, LIGHT GRAY, WITH CLIPSLOT, W/O CPA	33472-4902	B-LG-CLIP	GCO	PLR		M	RR										SALEABLE			
KEY C, BROWN, WITH CLIPSLOT, W/O CPA	33472-4903	C-BR-CLIP	GCO	PLR		M	RR										NOT RECOMMENDED	SEE P/N 33472-4922		
KEY D, GREEN, WITH CLIPSLOT, W/O CPA	33472-4904	D-GR-CLIP	GCO	PLR		M	RR										NOT RECOMMENDED	SEE P/N 33472-4923		
KEY D, BLACK, WITH CLIPSLOT, W/O CPA	33472-4905	D-BLK-CLIP	GCO	PLR		M	RR										SALEABLE			
KEY A, BLACK, WITH CLIPSLOT, W/CPA	33472-4906	A-BLK-CLIP	GCO	PLR	CPA	M	RR										SALEABLE			
KEY B, LIGHT GRAY, WITH CLIPSLOT, W/CPA	33472-4907	B-LG-CLIP	GCO	PLR	CPA	M	RR										SALEABLE			
KEY C, BROWN, WITH CLIPSLOT, W/CPA	33472-4908	C-BR-CLIP	GCO	PLR	CPA	M	RR										NOT RECOMMENDED	SEE P/N 33472-4924		
KEY D, GREEN, WITH CLIPSLOT, W/CPA	33472-4909	D-GR-CLIP	GCO	PLR	CPA	M	RR										NOT RECOMMENDED	SEE P/N 33472-4925		
KEY A, BLACK, WITH CLIPSLOT, W/O CPA	33472-4910	A-BLK-CLIP	GCP	PLR		M	RR				4						SALEABLE			
KEY A, BLACK, WITH CLIPSLOT, W/O CPA	33472-4920	A-BLK-CLIP	GCP	PLR		M	RR				4					8	SALEABLE			
KEY A, BLACK, WITH CLIPSLOT, W/O CPA	33472-4921	A-BLK-CLIP	GCP	PLR		M	RR									8	SALEABLE			
KEY C, DARK GRAY, WITH CLIPSLOT, W/O CPA	33472-4922	C-DG-CLIP	GCO	PLR		M	RR										SALEABLE			
KEY D, STONE GRAY, WITH CLIPSLOT, W/O CPA	33472-4923	D-SG-CLIP	GCO	PLR		M	RR										SALEABLE			
KEY C, DARK GRAY, WITH CLIPSLOT, W/CPA	33472-4924	C-DG-CLIP	GCO	PLR	CPA	M	RR										SALEABLE			
KEY D, STONE GRAY, WITH CLIPSLOT, W/CPA	33472-4925	D-SG-CLIP	GCO	PLR	CPA	M	RR										SALEABLE			

**MX150 RECEPTACLE 2X4 SEALED ASSEMBLY MAT SEAL  
BOM AND PIN OUT SHEET**

ASSEMBLY DESCRIPTION	ASSEMBLY PART NUMBER	COMPONENT						BLOCKED TERMINALS								STATUS	COMMENTS	OPTIONAL ATTACHMENTS SOLD SEPERATELY				
		THE PRESENCE OF AN ABBREVIATION INDICATES THE PRESENCE OF THAT COMPONENT.						CAVITY WITH A NUMBER INDICATES BLOCKED TERMINAL POSITION CAVITY WITHOUT A NUMBER INDICATES OPEN TERMINAL POSITION										BACKSHELL WITH RIBS	BACKSHELL WITHOUT RIBS			
		HOUSING KEY/COLOR	GROMMET CAP	PLR	CPA	MAT SEAL	RING SEAL	1	2	3	4	5	6	7	8							
KEY B, LIGHT GRAY, WITH CLIPSLOT, W/O CPA	33472-4926	B-LG-CLIP	GCP	PLR		M	RR							4				8	SALEABLE			
KEY A, BLACK, WITH CLIPSLOT, W/CPA	33472-4927	A-BLK-CLIP	GCP	PLR	CPA	M	RR							4				8	SALEABLE			
KEY B, LIGHT GRAY, WITH CLIPSLOT, W/CPA	33472-4928	B-LG-CLIP	GCP	PLR	CPA	M	RR							4				8	SALEABLE			
KEY A, BLACK, WITH CLIPSLOT, W/O CPA	33472-4929	A-BLK-CLIP	GCP	PLR		M	RR							4	5		7	8	SALEABLE			
KEY A, BLACK, WITH CLIPSLOT, W/O CPA	33472-4930	A-BLK-CLIP	GCP	PLR		M	RR			2	3			4	5		7	8	SALEABLE			
KEY A, BLACK, WITH CLIPSLOT, W/O CPA	33472-4931	A-BLK-CLIP	GCP	PLR		M	RR	1		2	3							6	SALEABLE			
KEY A, BLACK, WITH CLIPSLOT, W/O CPA	33472-4932	A-BLK-CLIP	GCP	PLR		M	RR	1										6	SALEABLE			
KEY A, BLACK, WITH CLIPSLOT, W/CPA	33472-4933	A-BLK-CLIP	GCP	PLR	CPA	M	RR											8	SALEABLE			
KEY B, LIGHT GRAY, WITH CLIPSLOT, W/CPA	33472-4934	B-LG-CLIP	GCP	PLR	CPA	M	RR											8	SALEABLE			
KEY A, BLACK, WITH CLIPSLOT, W/CPA	33472-4935	A-BLK-CLIP	GCP	PLR	CPA	M	RR			2	3						6	7	8	SALEABLE		
KEY A, BLACK, WITH CLIPSLOT, W/O CPA	33472-4936	A-BLK-CLIP	GCP	PLR		M	RR											6	7	8	SALEABLE	
KEY A, BLACK, WITH CLIPSLOT, W/O CPA	33472-4937	A-BLK-CLIP	GCP	PLR		M	RR								5				8	SALEABLE		
KEY A, BLACK, WITH CLIPSLOT, W/O CPA	33472-4938	A-BLK-CLIP	GCP	PLR		M	RR								5					SALEABLE		
KEY A, BLACK, WITH CLIPSLOT, W/O CPA	33472-4939	A-BLK-CLIP	GCP	PLR		M	RR				4			5		6	7	8	SALEABLE			
KEY A, BLACK, WITH CLIPSLOT, W/O CPA	33472-4940	A-BLK-CLIP	GCP	PLR		M	RR	1		2				5		6			SALEABLE			
KEY A, BLACK, WITH CLIPSLOT, W/O CPA	33472-4941	A-BLK-CLIP	GCP	PLR		M	RR	1		2	3			4		5		6	SALEABLE			

MX150 RECEPTACLE 2X6 SEALED ASSEMBLY MAT SEAL  
BOM AND PIN OUT SHEET

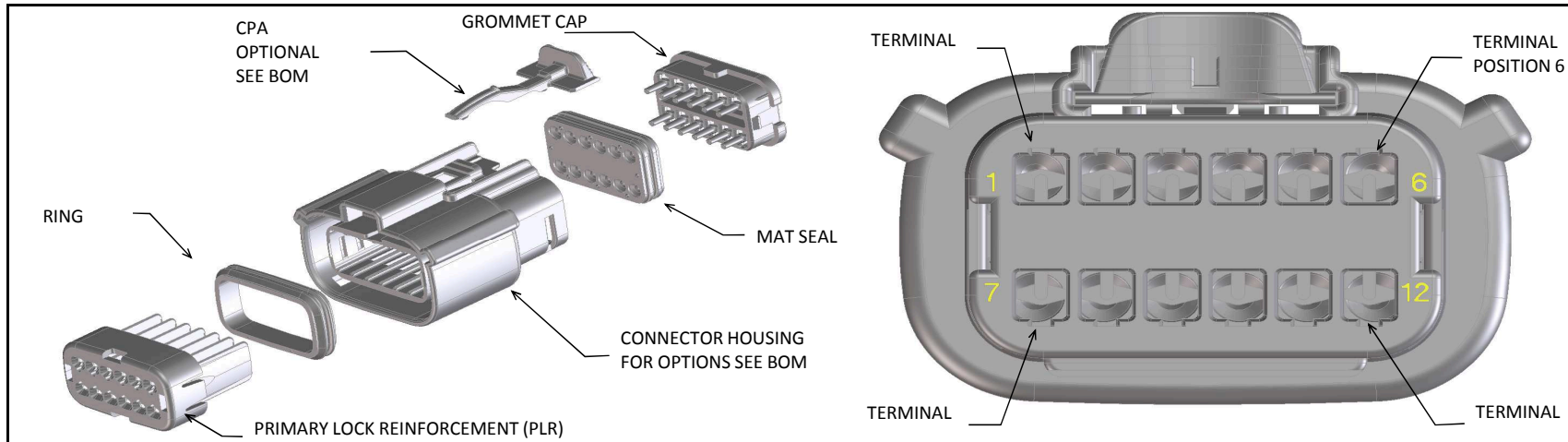

ABBREVIATION	DESCRIPTION	COLOR	MATERIAL
A-BLK	HOUSING, KEYING OPTION A	BLACK	SPS/NYLON GF20
B-LG	HOUSING, KEYING OPTION B	LIGHT GRAY	SPS/NYLON GF20
C-BR	HOUSING, KEYING OPTION C	BROWN	SPS/NYLON GF20
D-GR	HOUSING, KEYING OPTION D	GREEN	SPS/NYLON GF20
C-DG	HOUSING, KEYING OPTION C	DARK GRAY	SPS/NYLON GF20
D-SG	HOUSING, KEYING OPTION D	STONE GRAY	SPS/NYLON GF20
A-YW	HOUSING, KEYING OPTION A	YELLOW	SPS/NYLON GF20
A-BLK-CLIP	HOUSING, KEYING OPTION A WITH CLIPSLOT	BLACK	SPS/NYLON GF20
B-LG-CLIP	HOUSING, KEYING OPTION B WITH CLIPSLOT	LIGHT GRAY	SPS/NYLON GF20
C-BR-CLIP	HOUSING, KEYING OPTION C WITH CLIPSLOT	BROWN	SPS/NYLON GF20
D-GR-CLIP	HOUSING, KEYING OPTION D WITH CLIPSLOT	GREEN	SPS/NYLON GF20
C-DG-CLIP	HOUSING, KEYING OPTION C WITH CLIPSLOT	DARK GRAY	SPS/NYLON GF20
D-SG-CLIP	HOUSING, KEYING OPTION D WITH CLIPSLOT	STONE GRAY	SPS/NYLON GF20
GC	GROMMET CAP	BLACK	SPS/NYLON GF20
PLR	PLR	NATURAL	SPS/NYLON GF20
CPA	CPA	RED	PBT GF30
M	MAT SEAL	LIGHT BLUE	INHERENTLY LUBRICATED SILICONE
R	RING SEAL	GREEN	INHERENTLY LUBRICATED SILICONE

FOR ADDITIONAL INFORMATION SEE SD-33472-0001

ASSEMBLY DESCRIPTION	ASSEMBLY PART NUMBER	COMPONENT							BLOCKED TERMINALS												STATUS	COMMENTS	OPTIONAL ATTACHMENTS SOLD SEPERATELY	
		THE PRESENCE OF AN ABBREVIATION INDICATES THE PRESENCE OF THAT COMPONENT.							CAVITY WITH A NUMBER INDICATES BLOCKED TERMINAL POSITION CAVITY WITHOUT A NUMBER INDICATES OPEN TERMINAL POSITION														BACKSHELL WITH RIBS	BACKSHELL WITHOUT RIBS
		HOUSING KEY/COLOR	GROMMET CAP	PLR	CPA	MAT SEAL	RING SEAL	1	2	3	4	5	6	7	8	9	10	11	12					
KEY A, BLACK, W/O CPA	33472-1201	A-BLK	GC	PLR		M	R													SALEABLE		34951-1210	34951-1220	
KEY B, LIGHT GRAY, W/O CPA	33472-1202	B-LG	GC	PLR		M	R													SALEABLE		34951-1210	34951-1220	
KEY C, BROWN, W/O CPA	33472-1203	C-BR	GC	PLR		M	R													NOT RECOMMENDED	SEE P/N 33472-1253	34951-1210	34951-1220	
KEY D, GREEN, W/O CPA	33472-1204	D-GR	GC	PLR		M	R													NOT RECOMMENDED	SEE P/N 33472-1254	34951-1210	34951-1220	
VOID KEY	33472-1205																							
KEY A, BLACK, W/CPA	33472-1206	A-BLK	GC	PLR	CPA	M	R													SALEABLE		34951-1210	34951-1220	
KEY B, LIGHT GRAY, W/CPA	33472-1207	B-LG	GC	PLR	CPA	M	R													SALEABLE		34951-1210	34951-1220	
KEY C, BROWN, W/CPA	33472-1208	C-BR	GC	PLR	CPA	M	R													NOT RECOMMENDED	SEE P/N 33472-1259	34951-1210	34951-1220	
KEY D, GREEN, W/CPA	33472-1209	D-GR	GC	PLR	CPA	M	R													NOT RECOMMENDED	SEE P/N 33472-1260	34951-1210	34951-1220	
VOID KEY	33472-1210																							
KEY A, BLACK, W/O CPA	33472-1211	A-BLK	GC	PLR		M	R							6						SALEABLE		34951-1210	34951-1220	
KEY B, LIGHT GRAY, W/O CPA	33472-1212	B-LG	GC	PLR		M	R							6						SALEABLE		34951-1210	34951-1220	
KEY C, BROWN, W/O CPA	33472-1213	C-BR	GC	PLR		M	R							6						NOT RECOMMENDED		34951-1210	34951-1220	
KEY D, GREEN, W/O CPA	33472-1214	D-GR	GC	PLR		M	R							6						NOT RECOMMENDED		34951-1210	34951-1220	
VOID KEY	33472-1215																							
KEY A, BLACK, W/CPA	33472-1216	A-BLK	GC	PLR	CPA	M	R							6						SALEABLE		34951-1210	34951-1220	
KEY B, LIGHT GRAY, W/CPA	33472-1217	B-LG	GC	PLR	CPA	M	R							6						SALEABLE		34951-1210	34951-1220	
KEY C, BROWN, W/CPA	33472-1218	C-BR	GC	PLR	CPA	M	R							6						NOT RECOMMENDED		34951-1210	34951-1220	
KEY D, GREEN, W/CPA	33472-1219	D-GR	GC	PLR	CPA	M	R							6						NOT RECOMMENDED		34951-1210	34951-1220	
VOID KEY	33472-1220																							
KEY A, BLACK, W/O CPA	33472-1221	A-BLK	GC	PLR		M	R							6	7					SALEABLE		34951-1210	34951-1220	
KEY B, LIGHT GRAY, W/O CPA	33472-1222	B-LG	GC	PLR		M	R							6	7					SALEABLE		34951-1210	34951-1220	
KEY C, BROWN, W/O CPA	33472-1223	C-BR	GC	PLR		M	R							6	7					NOT RECOMMENDED		34951-1210	34951-1220	
KEY D, GREEN, W/O CPA	33472-1224	D-GR	GC	PLR		M	R							6	7					NOT RECOMMENDED		34951-1210	34951-1220	
VOID KEY	33472-1225																							
KEY A, BLACK, W/CPA	33472-1226	A-BLK	GC	PLR	CPA	M	R							6	7					SALEABLE		34951-1210	34951-1220	
KEY B, LIGHT GRAY, W/CPA	33472-1227	B-LG	GC	PLR	CPA	M	R							6	7					SALEABLE		34951-1210	34951-1220	
KEY C, BROWN, W/CPA	33472-1228	C-BR	GC	PLR	CPA	M	R							6	7					NOT RECOMMENDED		34951-1210	34951-1220	
KEY D, GREEN, W/CPA	33472-1229	D-GR	GC	PLR	CPA	M	R							6	7					NOT RECOMMENDED		34951-1210	34951-1220	
VOID KEY	33472-1230																							
KEY A, BLACK, W/O CPA	33472-1231	A-BLK	GC	PLR		M	R	1						6	7					SALEABLE		34951-1210	34951-1220	
KEY B, LIGHT GRAY, W/O CPA	33472-1232	B-LG	GC	PLR		M	R	1						6	7					SALEABLE		34951-1210	34951-1220	
KEY C, BROWN, W/O CPA	33472-1233	C-BR	GC	PLR		M	R	1						6	7					NOT RECOMMENDED		34951-1210	34951-1220	
KEY D, GREEN, W/O CPA	33472-1234	D-GR	GC	PLR		M	R	1						6	7					NOT RECOMMENDED		34951-1210	34951-1220	
VOID KEY	33472-1235																							
KEY A, BLACK, W/CPA	33472-1236	A-BLK	GC	PLR	CPA	M	R	1						6	7					SALEABLE		34951-1210	34951-1220	
KEY B, LIGHT GRAY, W/CPA	33472-1237	B-LG	GC	PLR	CPA	M	R	1						6	7					SALEABLE		34951-1210	34951-1220	
KEY C, BROWN, W/CPA	33472-1238	C-BR	GC	PLR	CPA	M	R	1						6	7					NOT RECOMMENDED		34951-1210	34951-1220	
KEY D, GREEN, W/CPA	33472-1239	D-GR	GC	PLR	CPA	M	R	1						6	7					NOT RECOMMENDED		34951-1210	34951-1220	
VOID KEY	33472-1240																							
KEY A, BLACK, W/O CPA	33472-1241	A-BLK	GC	PLR		M	R	1						6	7				12	SALEABLE		34951-1210	34951-1220	
KEY B, LIGHT GRAY, W/O CPA	33472-1242	B-LG	GC	PLR		M	R	1						6	7				12	SALEABLE		34951-1210	34951-1220	
KEY C, BROWN, W/O CPA	33472-1243	C-BR	GC	PLR		M	R	1						6	7				12	NOT RECOMMENDED		34951-1210	34951-1220	
KEY D, GREEN, W/O CPA	33472-1244	D-GR	GC	PLR		M	R	1						6	7				12	NOT RECOMMENDED		34951-1210	34951-1220	
VOID KEY	33472-1245																							
KEY A, BLACK, W/CPA	33472-1246	A-BLK	GC	PLR	CPA	M	R	1						6	7				12	SALEABLE		34951-1210	34951-1220	
KEY B, LIGHT GRAY, W/CPA	33472-1247	B-LG	GC	PLR	CPA	M	R	1						6	7				12	SALEABLE		34951-1210	34951-1220	
KEY C, BROWN, W/CPA	33472-1248	C-BR	GC	PLR	CPA	M	R	1						6	7				12	NOT RECOMMENDED		34951-1210	34951-1220	
KEY D, GREEN, W/CPA	33472-1249	D-GR	GC	PLR	CPA	M	R	1						6	7				12	NOT RECOMMENDED		34951-1210	34951-1220	
VOID KEY	33472-1250																							
KEY A, BLACK, W/O CPA	33472-1251	A-BLK	GC	PLR		M	R							6					12	SALEABLE		34951-1210	34951-1220	
KEY A, BLACK, W/CPA	33472-1252	A-BLK	GC	PLR	CPA	M	R									9	10			SALEABLE		34951-1210	34951-1220	
KEY C, DARK GRAY, W/O CPA	33472-1253	C-DG	GC	PLR		M	R													SALEABLE		34951-1210	34951-1220	
KEY D, STONE GRAY, W/O CPA	33472-1254	D-SG	GC	PLR		M	R													SALEABLE		34951-1210	34951-1220	
KEY A, BLACK, W/CPA	33472-1255	A-BLK	GC	PLR	CPA	M	R											11		SALEABLE		34951-1210	34951-1220	
KEY A, BLACK, W/CPA	33472-1256	A-BLK	GC	PLR	CPA	M	R									9	10	11	12	SALEABLE		34951-1210	34951-1220	
KEY A, BLACK, W/O CPA	33472-1257	A-BLK	GC	PLR		M	R									8				SALEABLE		34951-1210	34951-1220	
KEY A, BLACK, W/O CPA	33472-1258	A-BLK	GC	PLR		M	R	1	2	3	4	5	6	7	8	9	10	11	12	SALEABLE		34951-1210	34951-1220	
KEY C, DARK GRAY, W/CPA	33472-1259	C-DG	GC	PLR	CPA	M	R													SALEABLE		34951-1210	34951-1220	
KEY D, STONE GRAY, W/CPA	33472-1260	D-SG	GC	PLR	CPA	M	R													SALEABLE		34951-1210	34951-1220	
KEY A, BLACK, W/O CPA	33472-1261	A-BLK	GC	PLR		M	R									9	10		12	SALEABLE		34951-1210	34951-1220	

MX150 RECEPTACLE 2X6 SEALED ASSEMBLY MAT SEAL  
BOM AND PIN OUT SHEET

ASSEMBLY DESCRIPTION	ASSEMBLY PART NUMBER	COMPONENT						BLOCKED TERMINALS												STATUS	COMMENTS	OPTIONAL ATTACHMENTS SOLD SEPERATELY			
		THE PRESENCE OF AN ABBREVIATION INDICATES THE PRESENCE OF THAT COMPONENT.						CAVITY WITH A NUMBER INDICATES BLOCKED TERMINAL POSITION CAVITY WITHOUT A NUMBER INDICATES OPEN TERMINAL POSITION														BACKSHELL WITH RIBS	BACKSHELL WITHOUT RIBS		
		HOUSING KEY/COLOR	GROMMET CAP	PLR	CPA	MAT SEAL	RING SEAL	1	2	3	4	5	6	7	8	9	10	11	12						
KEY A, BLACK, W/CPA	33472-1262	A-BLK	GC	PLR	CPA	M	R								8	9	10	11	12	SALEABLE			34951-1210	34951-1220	
KEY B, LIGHT GRAY, W/CPA	33472-1263	B-LG	GC	PLR	CPA	M	R													12	SALEABLE			34951-1210	34951-1220
KEY C, DARK GRAY, W/CPA	33472-1264	C-DG	GC	PLR	CPA	M	R											11	12	SALEABLE			34951-1210	34951-1220	
KEY D, STONE GRAY, W/CPA	33472-1265	D-SG	GC	PLR	CPA	M	R													12	SALEABLE			34951-1210	34951-1220
KEY A, BLACK, W/CPA	33472-1266	A-BLK	GC	PLR	CPA	M	R											11	12	SALEABLE			34951-1210	34951-1220	
KEY D, STONE GRAY, W/CPA	33472-1267	D-SG	GC	PLR	CPA	M	R	1						6	7					SALEABLE			34951-1210	34951-1220	
KEY A, BLACK, W/CPA	33472-1268	A-BLK	GC	PLR	CPA	M	R	1						7						SALEABLE			34951-1210	34951-1220	
KEY A, BLACK, W/CPA	33472-1269	A-BLK	GC	PLR	CPA	M	R	1	2			4		6	7	8		10	11	12	SALEABLE			34951-1210	34951-1220
KEY A, BLACK, W/CPA	33472-1270	A-BLK	GC	PLR	CPA	M	R							7						SALEABLE			34951-1210	34951-1220	
KEY A, BLACK, W/CPA	33472-1271	A-BLK	GC	PLR	CPA	M	R					4		6				10	11	12	SALEABLE			34951-1210	34951-1220
KEY A, BLACK, W/CPA	33472-1272	A-BLK	GC	PLR	CPA	M	R							6		9	10	11	12	SALEABLE			34951-1210	34951-1220	
KEY A, BLACK, W/O CPA	33472-1273	A-BLK	GC	PLR		M	R							6		9	10	11	12	SALEABLE			34951-1210	34951-1220	
KEY A, BLACK, W/CPA	33472-1274	A-BLK	GC	PLR	CPA	M	R							6				11	12	SALEABLE			34951-1210	34951-1220	
KEY A, BLACK, W/O CPA	33472-1275	A-BLK	GC	PLR		M	R	1	2	3	4	5		6	8					SALEABLE			34951-1210	34951-1220	
KEY A, BLACK, W/O CPA	33472-1276	A-BLK	GC	PLR		M	R	1						6						SALEABLE			34951-1210	34951-1220	
KEY A, BLACK, W/O CPA	33472-1277	A-BLK	GC	PLR		M	R	1							7					SALEABLE			34951-1210	34951-1220	
KEY B, LIGHT GRAY, W/CPA	33472-1278	B-LG	GC	PLR	CPA	M	R											10	11	12	SALEABLE			34951-1210	34951-1220
KEY A, BLACK, W/O CPA	33472-1279	A-BLK	GC	PLR		M	R							7					11	SALEABLE			34951-1210	34951-1220	
KEY A, BLACK, W/O CPA	33472-1280	A-BLK	GC	PLR		M	R		2					7						SALEABLE			34951-1210	34951-1220	
KEY A, BLACK, W/O CPA	33472-1281	A-BLK	GC	PLR		M	R	1				4								SALEABLE			34951-1210	34951-1220	
KEY A, BLACK, W/CPA	33472-1282	A-BLK	GC	PLR	CPA	M	R	1	2					6	7	8				SALEABLE			34951-1210	34951-1220	
KEY A, BLACK, W/CPA	33472-1283	A-BLK	GC	PLR	CPA	M	R	1						6	7					SALEABLE			34951-1210	34951-1220	
KEY A, BLACK, W/CPA	33472-1284	A-BLK	GC	PLR	CPA	M	R	1	2	3	4	5		6	8					SALEABLE			34951-1210	34951-1220	
KEY A, BLACK, W/CPA	33472-1285	A-BLK	GC	PLR	CPA	M	R	1						6						SALEABLE			34951-1210	34951-1220	
KEY C, DARK GRAY, W/CPA	33472-1286	C-DG	GC	PLR	CPA	M	R	1						6	7					SALEABLE			34951-1210	34951-1220	
KEY A, BLACK, W/CPA	33472-1287	A-BLK	GC	PLR	CPA	M	R											10	11	12	SALEABLE			34951-1210	34951-1220
KEY C, DARK GRAY, W/CPA	33472-1288	C-DG	GC	PLR	CPA	M	R													SALEABLE			34951-1210	34951-1220	
KEY C, DARK GRAY, W/CPA	33472-1289	C-DG	GC	PLR	CPA	M	R									9	10	11	12	SALEABLE			34951-1210	34951-1220	
KEY A, BLACK, W/CPA	33472-1290	A-BLK	GC	PLR	CPA	M	R									9				SALEABLE			34951-1210	34951-1220	
KEY A, BLACK, W/CPA	33472-1291	A-BLK	GC	PLR	CPA	M	R	1					5	6	7	8				SALEABLE			34951-1210	34951-1220	
KEY A, YELLOW, W/CPA	33472-1292	A-YW	GC	PLR	CPA	M	R													SALEABLE			34951-1210	34951-1220	
KEY A, BLACK, W/CPA	33472-1293	A-BLK	GC	PLR	CPA	M	R	1												SALEABLE			34951-1210	34951-1220	
KEY A, BLACK, W/CPA	33472-1294	A-BLK	GC	PLR	CPA	M	R				4			7	8					SALEABLE			34951-1210	34951-1220	
KEY D, STONE GRAY, W/CPA	33472-1295	D-SG	GC	PLR	CPA	M	R												10	12	SALEABLE			34951-1210	34951-1220
KEY A, BLACK, W/CPA	33472-1296	A-BLK	GC	PLR	CPA	M	R								8	9	10	11	12	SALEABLE			34951-1210	34951-1220	
KEY A, BLACK, W/CPA	33472-1297	A-BLK	GC	PLR	CPA	M	R	1	2	3	4	5	6		9	10	11	12	SALEABLE			34951-1210	34951-1220		
KEY A, BLACK, WITH CLIPSLOT, W/O CPA	33472-1301	A-BLK-CLIP	GC	PLR		M	R													SALEABLE					
KEY B, LIGHT GRAY, WITH CLIPSLOT, W/O CPA	33472-1302	B-LG-CLIP	GC	PLR		M	R													SALEABLE					
KEY C, BROWN, WITH CLIPSLOT, W/O CPA	33472-1303	C-BR-CLIP	GC	PLR		M	R													NOT RECOMMENDED	SEE P/N 33472-1407				
KEY D, GREEN, WITH CLIPSLOT, W/O CPA	33472-1304	D-GR-CLIP	GC	PLR		M	R													NOT RECOMMENDED	SEE P/N 33472-1408				
VOID KEY	33472-1305																								
KEY A, BLACK, WITH CLIPSLOT, W/CPA	33472-1306	A-BLK-CLIP	GC	PLR	CPA	M	R													SALEABLE					
KEY B, LIGHT GRAY, WITH CLIPSLOT, W/CPA	33472-1307	B-LG-CLIP	GC	PLR	CPA	M	R													SALEABLE					
KEY C, BROWN, WITH CLIPSLOT, W/CPA	33472-1308	C-BR-CLIP	GC	PLR	CPA	M	R													NOT RECOMMENDED	SEE P/N 33472-1409				
KEY D, GREEN, WITH CLIPSLOT, W/CPA	33472-1309	D-GR-CLIP	GC	PLR	CPA	M	R													NOT RECOMMENDED	SEE P/N 33472-1410				
VOID KEY	33472-1310																								
KEY A, BLACK, WITH CLIPSLOT, W/O CPA	33472-1311	A-BLK-CLIP	GC	PLR		M	R	1	2	3	4	5	6	7	8	9	10	11	12	SALEABLE					
KEY B, LIGHT GRAY, WITH CLIPSLOT, W/O CPA	33472-1312	B-LG-CLIP	GC	PLR		M	R	1	2	3	4	5	6	7	8	9	10	11	12	SALEABLE					
KEY C, BROWN, WITH CLIPSLOT, W/O CPA	33472-1313	C-BR-CLIP	GC	PLR		M	R	1	2	3	4	5	6	7	8	9	10	11	12	NOT RECOMMENDED	SEE P/N 33472-1411				
KEY D, GREEN, WITH CLIPSLOT, W/O CPA	33472-1314	D-GR-CLIP	GC	PLR		M	R	1	2	3	4	5	6	7	8	9	10	11	12	NOT RECOMMENDED	SEE P/N 33472-1412				
VOID KEY	33472-1315																								
KEY A, BLACK, WITH CLIPSLOT, W/CPA	33472-1316	A-BLK-CLIP	GC	PLR	CPA	M	R	1	2	3	4	5	6	7	8	9	10	11	12	SALEABLE					
KEY B, LIGHT GRAY, WITH CLIPSLOT, W/CPA	33472-1317	B-LG-CLIP	GC	PLR	CPA	M	R	1	2	3	4	5	6	7	8	9	10	11	12	SALEABLE					
KEY C, BROWN, WITH CLIPSLOT, W/CPA	33472-1318	C-BR-CLIP	GC	PLR	CPA	M	R	1	2	3	4	5	6	7	8	9	10	11	12	NOT RECOMMENDED	SEE P/N 33472-1413				
KEY D, GREEN, WITH CLIPSLOT, W/CPA	33472-1319	D-GR-CLIP	GC	PLR	CPA	M	R	1	2	3	4	5	6	7	8	9	10	11	12	NOT RECOMMENDED	SEE P/N 33472-1414				
VOID KEY	33472-1320																								
KEY A, BLACK, WITH CLIPSLOT, W/O CPA	33472-1321	A-BLK-CLIP	GC	PLR		M	R		2	3					8				11	SALEABLE					
KEY A, BLACK, WITH CLIPSLOT, W/O CPA	33472-1322	A-BLK-CLIP	GC	PLR		M	R		2	3			5		6	7	8			SALEABLE					
KEY A, BLACK, WITH CLIPSLOT, W/O CPA	33472-1323	A-BLK-CLIP	GC	PLR		M	R							6	7					SALEABLE					
KEY A, BLACK, WITH CLIPSLOT, W/O CPA	33472-1324	A-BLK-CLIP	GC	PLR		M	R		2	3				6	7	8		10	11	SALEABLE					
KEY A, BLACK, WITH CLIPSLOT, W/O CPA	33472-1325	A-BLK-CLIP	GC	PLR		M	R	1						5	6	7	8			SALEABLE					
KEY B, LIGHT GRAY, WITH CLIPSLOT, W/O CPA	33472-1326	B-LG-CLIP	GC	PLR		M	R	1						5	6	7	8	9	10	SALEABLE					
KEY A, BLACK, WITH CLIPSLOT, W/O CPA	33472-1327	A-BLK-CLIP	GC	PLR		M	R													SALEABLE					
KEY B, LIGHT GRAY, WITH CLIPSLOT, W/O CPA	33472-1328	B-LG-CLIP	GC	PLR		M	R		2									9	10	SALEABLE					
KEY A, BLACK, WITH CLIPSLOT, W/O CPA	33472-1329	A-BLK-CLIP	GC	PLR		M	R									8	9	10	11	SALEABLE					
KEY A, BLACK, WITH CLIPSLOT, W/O CPA	33472-1330	A-BLK-CLIP	GC	PLR		M	R								7	8	9	10	11	SALEABLE					
KEY A, BLACK, WITH CLIPSLOT, W/O CPA	33472-1331	A-BLK-CLIP	GC	PLR		M	R								7	8				SALEABLE					
KEY A, BLACK, WITH CLIPSLOT, W/O CPA	33472-1332	A-BLK-CLIP	GC	PLR		M	R		2									9	10	SALEABLE					
KEY A, BLACK, WITH CLIPSLOT, W/O CPA	33472-1333	A-BLK-CLIP	GC	PLR		M	R		2			4								SALEABLE					
KEY A, BLACK, WITH CLIPSLOT, W/CPA	33472-1334	A-BLK-CLIP	GC	PLR	CPA	M	R										9	10	11	12	SALEABLE				
KEY A, BLACK, WITH CLIPSLOT, W/CPA	33472-1335	A-BLK-CLIP	GC	PLR	CPA	M	R													SALEABLE					
KEY A, BLACK, WITH CLIPSLOT, W/O CPA	33472-1336	A-BLK-CLIP	GC	PLR		M	R		2	3	4</														





MX150 RECEPTACLE 2X6 SEALED ASSEMBLY MAT SEAL  
BOM AND PIN OUT SHEET

ASSEMBLY DESCRIPTION	ASSEMBLY PART NUMBER	COMPONENT						BLOCKED TERMINALS												STATUS	COMMENTS	OPTIONAL ATTACHMENTS SOLD SEPERATELY	
		THE PRESENCE OF AN ABBREVIATION INDICATES THE PRESENCE OF THAT COMPONENT.						CAVITY WITH A NUMBER INDICATES BLOCKED TERMINAL POSITION CAVITY WITHOUT A NUMBER INDICATES OPEN TERMINAL POSITION														BACKSHELL WITH RIBS	BACKSHELL WITHOUT RIBS
		HOUSING KEY/COLOR	GROMMET CAP	PLR	CPA	MAT SEAL	RING SEAL	1	2	3	4	5	6	7	8	9	10	11	12				
KEY A, BLACK, WITH CLIPSLOT, W/O CPA	33472-1534	A-BLK-CLIP	GC	PLR		M	R		2	3					9				SALEABLE				
KEY A, BLACK, WITH CLIPSLOT, W/O CPA	33472-1535	A-BLK-CLIP	GC	PLR		M	R							8		10	11		SALEABLE				
KEY A, BLACK, WITH CLIPSLOT, W/O CPA	33472-1536	A-BLK-CLIP	GC	PLR		M	R	1		3		5		8		10	11		SALEABLE				
KEY A, BLACK, W/O CPA	33472-1537	A-BLK	GC	PLR		M	R	1				6	7	8	9	10			SALEABLE				
KEY A, BLACK, WITH CLIPSLOT, W/O CPA	33472-1538	A-BLK-CLIP	GC	PLR		M	R						7	8	9	10			SALEABLE				
KEY B, LIGHT GRAY, W/O CPA	33472-1539	B-LG	GC	PLR		M	R						7	8	9		12		SALEABLE				
KEY A, BLACK, WITH CLIPSLOT, W/O CPA	33472-1540	A-BLK-CLIP	GC	PLR		M	R	1				6	7	8	9	10			SALEABLE				
KEY A, BLACK, WITH CLIPSLOT, W/O CPA	33472-1541	A-BLK-CLIP	GC	PLR		M	R	1			4	6	7	8	9	10	11		SALEABLE				
KEY A, BLACK, WITH CLIPSLOT, W/O CPA	33472-1542	A-BLK-CLIP	GC	PLR		M	R	1	2	3		5	6	7	8	9	10	12	SALEABLE				
KEY A, BLACK, WITH CLIPSLOT, W/O CPA	33472-1543	A-BLK-CLIP	GC	PLR		M	R		2		4	6	7	8	9	10	11	12	SALEABLE				
KEY A, BLACK, WITH CLIPSLOT, W/O CPA	33472-1544	A-BLK-CLIP	GC	PLR		M	R			3	4				9	10	11	12	SALEABLE				
KEY A, BLACK, WITH CLIPSLOT, W/O CPA	33472-1545	A-BLK-CLIP	GC	PLR		M	R			3	4						11	12	SALEABLE				
KEY A, BLACK, WITH CLIPSLOT, W/O CPA	33472-1546	A-BLK-CLIP	GC	PLR		M	R	1	2			5	6	7	8	9	10		SALEABLE				
KEY A, BLACK, WITH CLIPSLOT, W/O CPA	33472-1547	A-BLK-CLIP	GC	PLR		M	R								9	10			SALEABLE				
KEY A, BLACK, W/CPA	33472-1548	A-BLK	GC	PLR	CPA	M	R					5							SALEABLE				
KEY A, BLACK, W/CPA	33472-1549	A-BLK	GC	PLR	CPA	M	R					6							SALEABLE				
KEY A, BLACK, WITH CLIPSLOT, W/O CPA	33472-1550	A-BLK-CLIP	GC	PLR		M	R									10	11	12	SALEABLE				
KEY A, BLACK, WITH CLIPSLOT, W/O CPA	33472-1551	A-BLK-CLIP	GC	PLR		M	R								9				SALEABLE				
KEY A, BLACK, WITH CLIPSLOT, W/O CPA	33472-1552	A-BLK-CLIP	GC	PLR		M	R		2					8	9	10	11	12	SALEABLE				
KEY A, BLACK, WITH CLIPSLOT, W/O CPA	33472-1553	A-BLK-CLIP	GC	PLR		M	R		2					8	9				SALEABLE				
KEY A, BLACK, W/O CPA	33472-1554	A-BLK	GC	PLR		M	R						7	8	9	10	11	12	SALEABLE	SEE P/N 33472-1484			
KEY A, BLACK, W/CPA	33472-1555	A-BLK	GC	PLR	CPA	M	R						7	8	9	10	11	12	SALEABLE				
KEY A, BLACK, WITH CLIPSLOT, W/O CPA	33472-1556	A-BLK-CLIP	GC	PLR		M	R					5				10	11		SALEABLE				
KEY A, BLACK, WITH CLIPSLOT, W/O CPA	33472-1557	A-BLK-CLIP	GC	PLR		M	R	1			4	5		8		10	11	12	SALEABLE				
KEY A, BLACK, WITH CLIPSLOT, W/O CPA	33472-1558	A-BLK-CLIP	GC	PLR		M	R	1	2	3	4				9	10	11	12	SALEABLE				
KEY A, BLACK, WITH CLIPSLOT, W/CPA	33472-1559	A-BLK-CLIP	GC	PLR	CPA	M	R	1	2	3	4	5	6	7	8				SALEABLE				
KEY A, BLACK, WITH CLIPSLOT, W/O CPA	33472-1560	A-BLK-CLIP	GC	PLR		M	R		2							10	11	12	SALEABLE				
KEY A, BLACK, WITH CLIPSLOT, W/O CPA	33472-1561	A-BLK-CLIP	GC	PLR		M	R								10				SALEABLE				
KEY A, BLACK, W/O CPA	33472-1562	A-BLK	GC	PLR		M	R	1				5	6	7	8			12	SALEABLE				
KEY A, BLACK, W/O CPA	33472-1563	A-BLK	GC	PLR		M	R	1	2	3		5	6	7	8		10	11	12	SALEABLE			
KEY A, BLACK, WITH CLIPSLOT, W/O CPA	33472-1564	A-BLK-CLIP	GC	PLR		M	R							7	8	9		12	SALEABLE				
KEY B, LIGHT GRAY, WITH CLIPSLOT, W/O CPA	33472-1565	B-LG-CLIP	GC	PLR		M	R					5			8	9	10		SALEABLE				
KEY B, LIGHT GRAY, WITH CLIPSLOT, W/O CPA	33472-1566	B-LG-CLIP	GC	PLR		M	R							8					SALEABLE				
KEY A, BLACK, WITH CLIPSLOT, W/O CPA	33472-1567	A-BLK-CLIP	GC	PLR		M	R				4	5		7	8	9	10	11	12	SALEABLE			
KEY A, BLACK, W/CPA	33472-1568	A-BLK	GC	PLR	CPA	M	R							8					SALEABLE				
KEY A, BLACK, W/CPA	33472-1569	A-BLK	GC	PLR	CPA	M	R	1	2	3	4		6		8	9	10	11	12	SALEABLE			
KEY A, BLACK, W/CPA	33472-1570	A-BLK	GC	PLR	CPA	M	R	1	2	3			6		8			11	12	SALEABLE			
KEY A, BLACK, WITH CLIPSLOT, W/O CPA	33472-1571	A-BLK-CLIP	GC	PLR		M	R				4	5		7	8		10	11	12	SALEABLE			
KEY A, BLACK, W/O CPA	33472-1572	A-BLK	GC	PLR		M	R		2	3		5	6	7	8		10	11	12	SALEABLE			
KEY A, BLACK, W/O CPA	33472-1573	A-BLK	GC	PLR		M	R	1			4	5			9	10	11	12	SALEABLE				
KEY A, BLACK, W/O CPA	33472-1574	A-BLK	GC	PLR		M	R				4	5							SALEABLE				
KEY A, BLACK, W/O CPA	33472-1575	A-BLK	GC	PLR		M	R									10	11	12	SALEABLE				















MX150 RECEPTACLE 2X10 SEALED ASSEMBLY MAT SEAL  
BOM AND PIN OUT SHEET

ASSEMBLY DESCRIPTION	ASSEMBLY PART NUMBER	COMPONENT						BLOCKED TERMINALS																				STATUS	COMMENTS	OPTIONAL ATTACHMENTS SOLD SEPERATELY				
		THE PRESENCE OF AN ABBREVIATION INDICATES THE PRESENCE OF THAT COMPONENT.						CAVITY WITH A NUMBER INDICATES BLOCKED TERMINAL POSITION CAVITY WITHOUT A NUMBER INDICATES OPEN TERMINAL POSITION																						BACKSHELL WITH RIBS	BACKSHELL WITHOUT RIBS			
		HOUSING KEY/COLOR	GROMMET CAP	PLR	CPA	MAT SEAL	RING SEAL	1	2	3	4	5	6	7	8	9	10	11	12	13	14	15	16	17	18	19	20							
KEY A, BLACK, W/O CPA	33472-2078	A-BLK	GCP	PLR		M	R	1	2	3	4	5	6		8	10							16	17	18	19	20	SALEABLE						
KEY A, BLACK, W/O CPA	33472-2079	A-BLK	GCP	PLR		M	R		2						8								16	17	18	19	20	SALEABLE						
KEY A, BLACK, W/O CPA	33472-2080	A-BLK	GCP	PLR		M	R																16	17	18	19	20	SALEABLE						
KEY A, BLACK, W/O CPA	33472-2081	A-BLK	GCP	PLR		M	R	1	2	3	4	5	6	7	8	9	10							17	18	19	20	SALEABLE						
KEY A, BLACK, W/O CPA	33472-2082	A-BLK	GCP	PLR		M	R							7		9								17	18	19	20	SALEABLE						
KEY A, BLACK, W/O CPA	33472-2083	A-BLK	GCP	PLR		M	R										10							17	18	19	20	SALEABLE						
KEY A, BLACK, W/O CPA	33472-2084	A-BLK	GCP	PLR		M	R	1	2	3	4	5	6	7	8	9	10							17	18	19	20	SALEABLE						
KEY A, BLACK, W/O CPA	33472-2085	A-BLK	GCP	PLR		M	R	1	2	3	4	5	6	7	8	9	10		12					17	18	19	20	SALEABLE						
KEY A, BLACK, W/O CPA	33472-2086	A-BLK	GCP	PLR		M	R	1	2	3	4	5	6	7	8	9	10					14	15		17	18	19	20	SALEABLE					
KEY A, BLACK, W/O CPA	33472-2087	A-BLK	GCP	PLR		M	R															14	15		17	18	19	20	SALEABLE					
KEY A, BLACK, W/O CPA	33472-2088	A-BLK	GCP	PLR		M	R							7										17	18	19	20	SALEABLE						
KEY A, YELLOW, W/CPA	33472-2089	A-YW	GCO	PLR	CPA	M	R																					SALEABLE						
KEY A, BLACK, W/O CPA	33472-2090	A-BLK	GCP	PLR		M	R																				20	SALEABLE						
KEY A, BLACK, W/O CPA	33472-2091	A-BLK	GCP	PLR		M	R		2														15	16				SALEABLE						
KEY A, BLACK, W/CPA	33472-2092	A-BLK	GCP	PLR	CPA	M	R							7														SALEABLE						
KEY A, YELLOW, W/O CPA	33472-2093	A-YW	GCO	PLR		M	R																					SALEABLE						
KEY A, BLACK, W/O CPA	33472-2094	A-BLK	GCP	PLR		M	R				4					10	11	12	13	14	15	16			18	19	20	SALEABLE						
KEY A, BLACK, W/CPA	33472-2095	A-BLK	GCP	PLR	CPA	M	R																					SALEABLE						
KEY A, BLACK, W/CPA	33472-2096	A-BLK	GCP	PLR	CPA	M	R		2		4																	SALEABLE						
KEY A, BLACK, W/CPA	33472-2097	A-BLK	GCP	PLR	CPA	M	R									9	10											SALEABLE						
KEY A, BLACK, W/CPA	33472-2098	A-BLK	GCP	PLR	CPA	M	R	1																15	16	17	18	19	20	SALEABLE				
KEY A, BLACK, W/CPA	33472-2099	A-BLK	GCP	PLR	CPA	M	R	1	2	3	4	5	6	7	8	9												SALEABLE						
KEY A, BLACK, W/CPA	33472-2100	A-BLK	GCP	PLR	CPA	M	R			3	4	5	6		8	9												SALEABLE						
KEY A, BLACK, W/CPA	33472-2101	A-BLK	GCP	PLR	CPA	M	R	1	2	3	4	5	6															SALEABLE						
KEY A, BLACK, W/O CPA	33472-2102	A-BLK	GCP	PLR		M	R										10											SALEABLE						
KEY A, BLACK, W/CPA	33472-2103	A-BLK	GCP	PLR	CPA	M	R			3	4	5	6		8	9	10											SALEABLE						
KEY A, BLACK, W/CPA	33472-2104	A-BLK	GCP	PLR	CPA	M	R			3					8	9												SALEABLE						
KEY A, BLACK, W/O CPA	33472-2105	A-BLK	GCP	PLR		M	R																					SALEABLE						
KEY B, LIGHT GRAY, W/O CPA	33472-2106	B-LG	GCP	PLR		M	R						6	7	8													SALEABLE						
KEY B, LIGHT GRAY, W/O CPA	33472-2107	B-LG	GCP	PLR		M	R																					SALEABLE						
KEY B, LIGHT GRAY, W/O CPA	33472-2108	B-LG	GCP	PLR		M	R							6	7		9	10										SALEABLE						
KEY B, LIGHT GRAY, W/O CPA	33472-2109	B-LG	GCP	PLR		M	R				3		5	6	7		9	10										SALEABLE						
KEY B, LIGHT GRAY, W/O CPA	33472-2110	B-LG	GCP	PLR		M	R				3		5				9	10										SALEABLE						
KEY B, LIGHT GRAY, W/O CPA	33472-2111	B-LG	GCP	PLR		M	R				3	4	5				9	10										SALEABLE						
KEY B, LIGHT GRAY, W/O CPA	33472-2112	B-LG	GCP	PLR		M	R				3	4	5				9	10						15		17	18	19	20	SALEABLE				
KEY B, LIGHT GRAY, W/O CPA	33472-2113	B-LG	GCP	PLR		M	R				3	4	5	6	7		9	10						15		17	18	19	20	SALEABLE				
KEY B, LIGHT GRAY, W/CPA	33472-2114	B-LG	GCP	PLR	CPA	M	R				3	4	5	6														SALEABLE						
KEY A, YELLOW, W/CPA	33472-2115	A-YW	GCP	PLR	CPA	M	R				3				6	7	8	9	10	11	12	13	14				SALEABLE							
KEY A, YELLOW, W/CPA	33472-2116	A-YW	GCP	PLR	CPA	M	R				3				6	7	8	9	10	11	12	13	14				SALEABLE							
KEY A, YELLOW, W/CPA	33472-2117	A-YW	GCP	PLR	CPA	M	R				3				6	7	8	9	10	11	12	13	14	15			SALEABLE							
KEY A, YELLOW, W/CPA	33472-2118	A-YW	GCP	PLR	CPA	M	R				3	4	5	6	7	8	9	10	11	12	13	14	15	16	17	18	19	20	SALEABLE					
KEY A, YELLOW, W/CPA	33472-2119	A-YW	GCP	PLR	CPA	M	R				3	4	5	6	7	8	9	10	11	12	13	14	15	16	17	18	19	20	SALEABLE					
KEY A, YELLOW, W/CPA	33472-2120	A-YW	GCP	PLR	CPA	M	R				3				7	8	9	10	11	12	13	14	15	16	17	18	19	20	SALEABLE					
KEY A, BLACK, W/CPA	33472-2121	A-BLK	GCP	PLR	CPA	M	R																					SALEABLE						
KEY A, BLACK, W/CPA	33472-2122	A-BLK	GCP	PLR	CPA	M	R			2	3	4	5															SALEABLE						
KEY A, BLACK, W/O CPA	33472-2123	A-BLK	GCP	PLR		M	R								8													SALEABLE						
KEY A, BLACK, W/O CPA	33472-2124	A-BLK	GCP	PLR		M	R																					SALEABLE						
KEY A, BLACK, W/O CPA	33472-2125	A-BLK	GCP	PLR		M	R	1	2	3	4	5	6	7	8	9	10	11	12	13	14	15	16	17	18	19	20	SALEABLE						
KEY A, BLACK, W/CPA	33472-2126	A-BLK	GCP	PLR	CPA	M	R	1							8	9												SALEABLE						
KEY A, BLACK, W/CPA	33472-2127	A-BLK	GCP	PLR	CPA	M	R	1							8	9												SALEABLE						
KEY A, BLACK, W/O CPA	33472-2128	A-BLK	GCP	PLR		M	R	1							8	9	10											SALEABLE						
KEY A, BLACK, W/O CPA	33472-2129	A-BLK	GCP	PLR		M	R	1							8	9	10	11										SALEABLE						
KEY A, BLACK, W/CPA	33472-2130	A-BLK	GCP	PLR	CPA	M	R	1							8	9	10											SALEABLE						
KEY A, BLACK, W/O CPA	33472-2131	A-BLK	GCP	PLR		M	R				4																	SALEABLE						
KEY A, BLACK, W/O CPA	33472-2132	A-BLK	GCP	PLR		M	R				4	5	6	7	8	9	10	11	12	13	14	15	16	17	18	19	20	SALEABLE						
KEY A, BLACK, W/O CPA	33472-2133	A-BLK	GCP	PLR		M	R	1	2	3	4	5	6	7	8	9	10	11	12	13	14	15	16	17	18	19	20	SALEABLE						
KEY A, BLACK, W/O CPA	33472-2134	A-BLK	GCP	PLR		M	R	1																				SALEABLE						
KEY A, BLACK, W/O CPA	33472-2135	A-BLK	GCP	PLR		M	R	1																				SALEABLE						
KEY A, BLACK, W/O CPA	33472-2136	A-BLK	GCP	PLR		M	R	1	2	3	4	5	6	7	8	9	10	11	12	13	14	15	16				SALEABLE							
KEY A, BLACK, W/O CPA	33472-2137	A-BLK	GCP	PLR		M	R	1																				SALEABLE						
KEY A, BLACK, W/CPA	33472-2138	A-BLK	GCP	PLR	CPA	M	R																					SALEABLE						
KEY A, BLACK, W/O CPA	33472-2139	A-BLK	GCP	PLR		M	R	1	2	3	4	5	6		8	9	10											SALEABLE						
KEY A, BLACK, W/O CPA	33472-2140	A-BLK	GCP	PLR		M	R		2																									

