

G2-LAURA-O90-P

~15° x 40° oval beam. Assembly with thinner white holder, installation tape and location pins.
Variant with beam direction rotated 90°.

TECHNICAL SPECIFICATIONS:

Dimensions	21.6 mm
Height	13.1 mm
Fastening	tape, pin
Colour	white
Box size	
Box weight	6.2 kg
Quantity in Box	1440 pcs
ROHS compliant	yes ⓘ

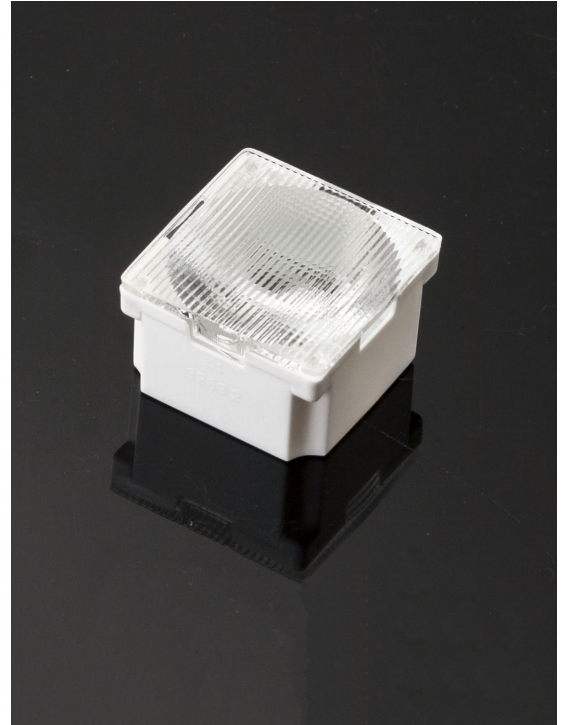

MATERIAL SPECIFICATIONS:

Component	Type	Material	Colour
LAURA-O-90	Lens	PMMA	clear
LAURA-LT-PIN-XP-HLD-WHT	Holder	PC	white
ROSE-TAPE	Tape	PU tape	black

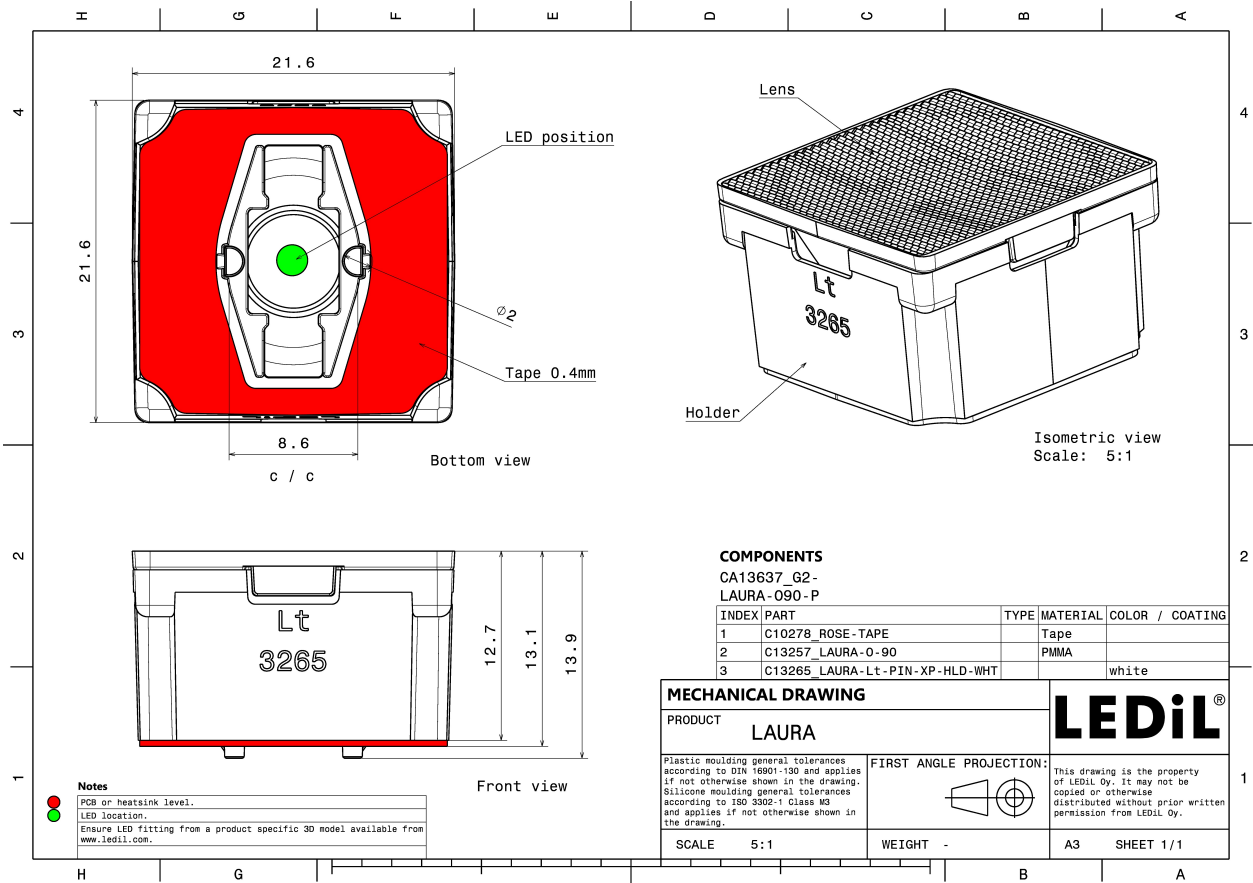

PHOTOMETRIC DATA (MEASURED):



LED XP-E
FWHM 11.0 + 40.0°
Efficiency 91 %
Peak intensity 6.290 cd/lm
Required components:

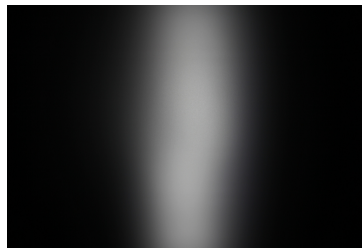

LED XP-G3
FWHM 15.0 + 37.0°
Efficiency 90 %
Peak intensity 4.100 cd/lm
Required components:

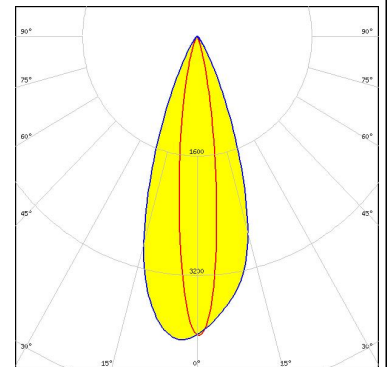
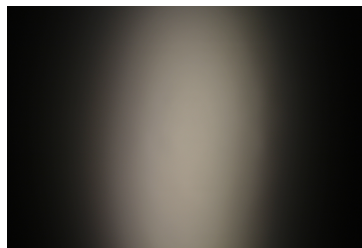

LED XP-L
FWHM 16.0 + 38.0°
Efficiency 89 %
Peak intensity 3.710 cd/lm
Required components:

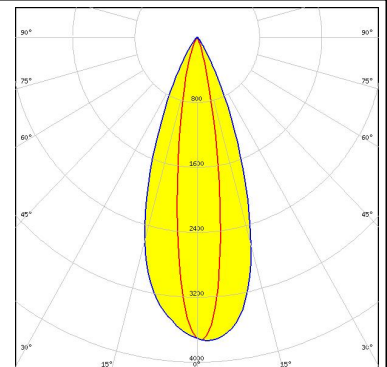
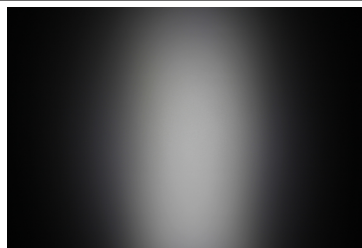

LED XP-L2
FWHM 18.0 + 37.0°
Efficiency 86 %
Peak intensity 3.100 cd/lm
Required components:

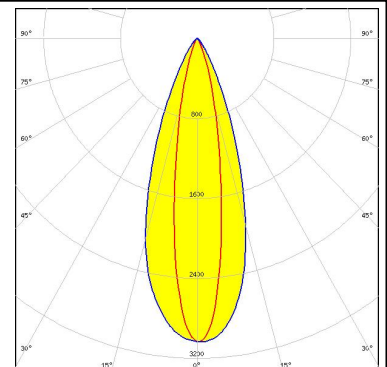
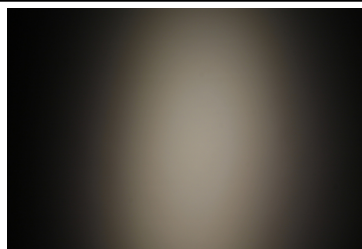

PHOTOMETRIC DATA (MEASURED):

LUMILEDS

LED LUXEON 3030 2D (Round LES)
FWHM 14.0 + 37.0°
Efficiency 90 %
Peak intensity 4.400 cd/lm
Required components:

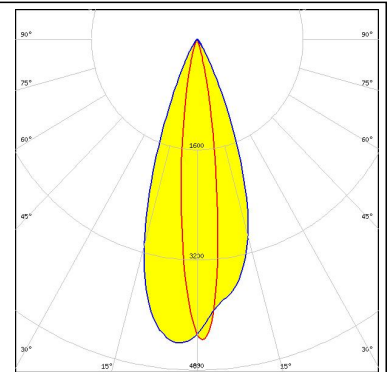
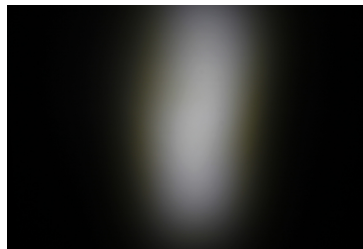

LUMILEDS

LED LUXEON Rebel Plus
FWHM 12.0 + 38.0°
Efficiency 91 %
Peak intensity 5.200 cd/lm
Required components:

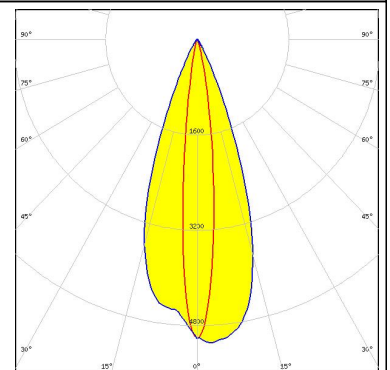
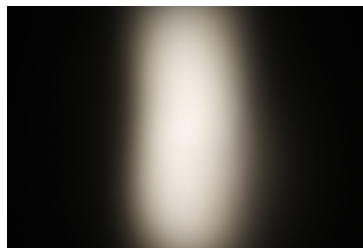

LUMILEDS

LED LUXEON TX
FWHM 15.0 + 41.0°
Efficiency 89 %
Peak intensity 4.400 cd/lm
Required components:

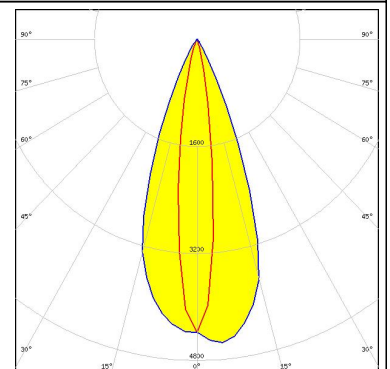
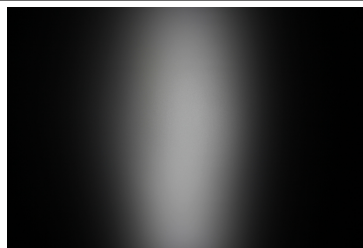

NICHIA

LED NCSxx19A
FWHM 15.0 + 41.0°
Efficiency 91 %
Peak intensity 4.500 cd/lm
Required components:

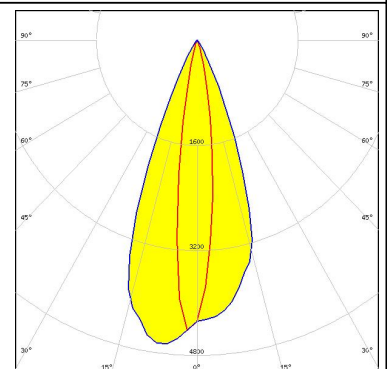
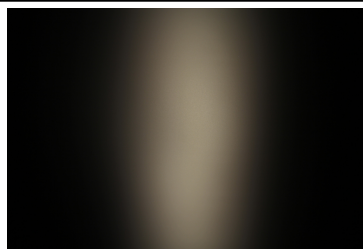

PHOTOMETRIC DATA (MEASURED):



LED NVSxx19A
FWHM 16.0 + 40.0°
Efficiency 89 %
Peak intensity 4.100 cd/lm
Required components:

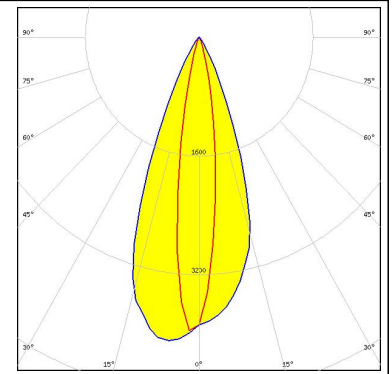
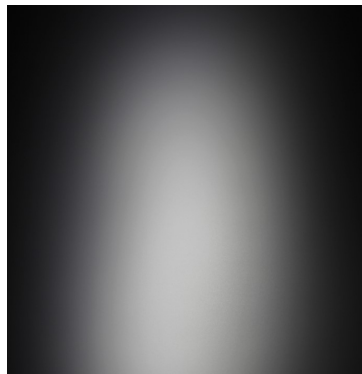

LED NVSxx19B/NVSxx19C
FWHM 15.0 + 38.0°
Efficiency 88 %
Peak intensity 4.400 cd/lm
Required components:

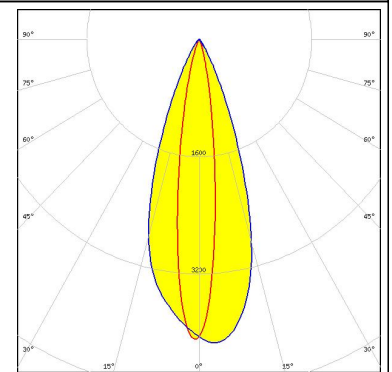
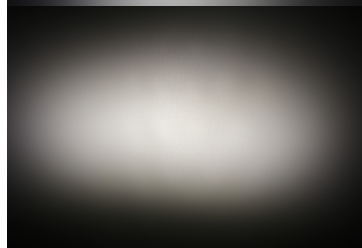

GENERAL INFORMATION:

NOTE: The typical beam angle will be changed by different color, chip size and chip position tolerance. The typical total beam angle is the full angle measured where the luminous intensity is half of the peak value.

MATERIALS:

As part of our continuous research and improvement processes, and to ensure the best possible quality and availability of our products, LEDiL reserves the right to change material grades without notice.

PRODUCT DATA USER AGREEMENT AND DISCLAIMER:

The measured data in the provided downloadable LEDiL Product Datasheets and Mechanical 2D-Drawings is rounded and provided as reference for planning. LEDiL Oy's optical specifications have been verified by conducting performance testing of the products in accordance with the company's quality system. The reported data are averaged results of multiple measurements with typical variation. LEDiL Oy reserves the right to without prior notification make changes and improvements to its products.

LEDiL Oy assumes neither warranty, nor guarantee nor any other liability of any kind for the contents and correctness of the provided data. The provided data has been generated with highest diligence but the provided data may in reality not represent the complete possible variation range of all intrinsic parameters. Therefore, in certain cases a deviation from the provided data could occur.

LEDiL Oy reserves the right to undertake technical changes of its products without further notification which could lead to changes in the provided data. LEDiL Oy assumes no liability of any kind for the possible deviation from any provided data or any other damage resulting from the usage of the provided data.

The user agrees to this disclaimer and user agreement with the download or usage of the provided files.

LEDiL Oy

Joensuunkatu 13
FI-24240 SALO
Finland

LEDiL Inc.

228 West Page Street
Suite D
Sycamore IL 60178
USA

Local sales and technical support

[www.ledil.com/
where_to_buy](http://www.ledil.com/where_to_buy)

Shipping locations

Salo, Finland
Hong Kong, China

Distribution Partners

[www.ledil.com/
where_to_buy](http://www.ledil.com/where_to_buy)