

PM8800 demonstration kit for standard and high power PoE PD interface and power supply, with auxiliary sources

Introduction

This document details the characteristics and performances of the PM8800 demonstration kit which has been designed to cover a broad range of power over Ethernet (PoE) applications. PM8800 is a highly integrated device embedding an IEEE802.3af compliant powered device (PD) interface together with a PWM controller and support for auxiliary sources.

Even though PM8800 can be configured to work in both isolated and non-isolated topologies, this application note focuses on an isolated topology only, in two different output power configurations (10 W and 20 W) and 2 different output voltages (5 V and 3.3 V).

The PM8800 demonstration kit supports diode as well as synchronous rectification.

Auxiliary sources can be connected to the board on 2 input points. One input allows prevalence of the auxiliary sources with respect to the PoE, while the other input allows the usage of a wall adaptor with voltage lower than the internal PoE UVLO threshold and still benefits from the inherent inrush and DC current limit.

The above mentioned configurations are all supported by the PM8800 demonstration kit as options on the same PCB. The bill of material (BOM) (see [Section 5 on page 12](#)) provides the list of components to be mounted for each of the targeted configurations.

Figure 1. PM8800 demonstration kit

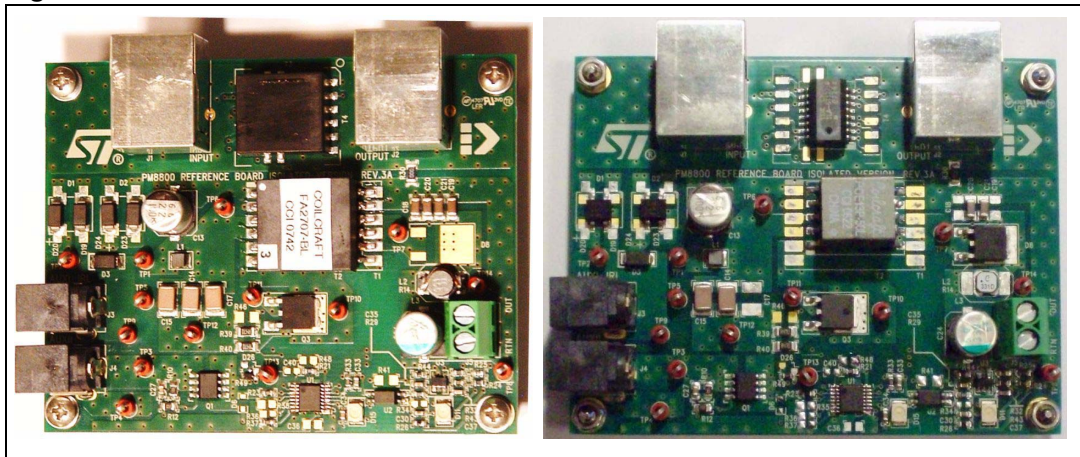

The high-power board appears on the left of the photo and standard board is on the right.

Contents

1	Main features	6
2	Electrical specifications	7
3	Demonstration kit schematic	8
4	Board layout	9
	4.1 Input/output connectors	11
	4.2 Notes	11
5	Bill of material	12
6	Power-up sequence	16
7	Input section	17
	7.1 Diode bridges	17
	7.2 Input capacitors	17
	7.3 Transient voltage suppression	17
8	PoE section	18
	8.1 Signature	18
	8.2 Classification	18
	8.3 UVLO and power-on	19
	8.4 Inrush current limit	19
	8.5 DC current limit	20
	8.6 AUXI input	21
	8.7 AUXII input	21
9	Power transformer and operating input voltage	22
10	Power converter	23
	10.1 Flyback continuous conduction mode	23
	10.2 Main switch current and current sensing	24
	10.3 Main switch power dissipation	24

10.4	Rectifier diode dissipation	25
10.5	PM8800 internal power dissipation	26
11	Layout guidelines	27
12	Test results	29
12.1	Efficiency measurements	29
12.2	5 V high-power board measurements	31
12.3	3.3 V standard-power board measurements	36
12.4	IEEE 802.3af compatibility test	42
Appendix A	Schematic of high-power board	44
Appendix B	Schematic of standard-power board	45
Revision history		46

List of figures

Figure 1.	PM8800 demonstration kit	1
Figure 2.	Demonstration kit schematic	8
Figure 3.	Assembly view: top and bottom layer	9
Figure 4.	Top layer	10
Figure 5.	Inner layer 1	10
Figure 6.	Inner layer 2	10
Figure 7.	Bottom layer	11
Figure 8.	Inrush current limit vs. RIRL	19
Figure 9.	DC current limit vs. RDC	20
Figure 10.	Output power vs. VAUXII	22
Figure 11.	5 V out - standard board with diode rectification	29
Figure 12.	5 V out - high-power board with synchronous rectification	29
Figure 13.	3.3 V out - standard board with diode rectification	30
Figure 14.	3.3 V out - high-power board with synchronous rectification	30
Figure 15.	Startup of the PM8800 demonstration kit with 5 V 1 A	31
Figure 16.	Startup of the PM8800 demonstration kit with 5 V 4 A	31
Figure 17.	Details of the inrush phase	31
Figure 18.	Details of the soft-start phase	31
Figure 19.	VDS and VGS of the primary MOSFET for 5 V 1 A	32
Figure 20.	VDS and VGS of the primary MOSFET for 5 V 4 A	32
Figure 21.	Details of the synchronous rectifier MOSFET voltage with 48 V and 4 A out	32
Figure 22.	Output voltage ripple at 4 A output current	33
Figure 23.	Output voltage ripple at 4 A output current (1 sec persistence)	33
Figure 24.	Dynamic load 1 A to 4 A: output voltage (up) and output current (down)	33
Figure 25.	PM8800A response to a 6 A overload condition	34
Figure 26.	PM8800A recovering from a 6 A overload condition	34
Figure 27.	PM8800A response to a short on the load	34
Figure 28.	PM8800A recovering from a short on the load	34
Figure 29.	Internal short on the secondary winding	35
Figure 30.	Switch between 48 V PoE and 24 V AUXII with 5 V at 2 A	35
Figure 31.	back to 48 V removing the 24 V AUXII voltage with 5 V at 2 A	35
Figure 32.	Switch between 48 V PoE and 12 V AUXII with 5 V at 2 A	36
Figure 33.	Back to 48 V removing the 12 V AUXII voltage with 5 V at 2 A	36
Figure 34.	Startup of the PM8800 demonstration kit with 3.3 V, 1 A	36
Figure 35.	Startup of the PM8800 demonstration kit with 3.3 V, 3 A	36
Figure 36.	Details of the inrush phase	37
Figure 37.	Details of the soft-start phase	37
Figure 38.	VDS and VGS of the primary MOSFET for 3.3 V 1 A	37
Figure 39.	VDS and VGS of the primary MOSFET for 3.3 V 3 A	37
Figure 40.	Details of the synchronous rectifier MOSFET voltage with 48 V and 3 A output current	38
Figure 41.	Output voltage ripple at 3 A output current	38
Figure 42.	Output voltage ripple at 3 A output current (1 sec persistence)	38
Figure 43.	Dynamic load 1 to 3 A: output voltage (up) and output current (down)	39
Figure 44.	PM8800A response to a 5 A overload condition	39
Figure 45.	PM8800A recovering from a 5 A overload condition	39
Figure 46.	PM8800A response to a short on the load	40
Figure 47.	PM8800A recovering from a short on the load	40
Figure 48.	Internal short on the secondary winding	40

Figure 49.	Switch between 48 V PoE and 24 V AUXII with 3.3 V at 2 A	41
Figure 50.	Back to 48 V removing the 24 V AUXII voltage with 3.3 V at 2 A	41
Figure 51.	Switch between 48 V PoE and 12 V AUXII with 3.3 V at 2 A	41
Figure 52.	Back to 48 V removing the 12 V AUXII voltage with 3.3 V at 2 A	41
Figure 53.	Schematic of the 3.3/5 Vout high power with synchronous rectification	44
Figure 54.	Schematic of the 3.3/5 Vout standard power with diode rectification	45

1 Main features

The PM8800 demonstration kit has been designed to cover several PoE configurations with easy customization.

- Basic configuration: (high-power applications)
 - 5 V output
 - Up to 4 A output
 - 250 kHz operating switching frequency
 - Flyback topology DCM/CCM
- Board size 70 x 90 mm
- Power Good indication
- Overall efficiency of 85% at full-load condition ([Figure 12](#))
- Prevalence of the auxiliary source with respect to the PoE line ([Section 8.7](#))
- 1500 Vrms isolation ensured by the power transformer
- Support for (see BOM options in [Section 5](#)):
 - 5 V and 3.3V output
 - diode or synchronous rectification
 - standard IEEE802.3af or high-power applications
 - non-isolated flyback topology
- Support for class 0-3 (IEEE802.3af) and class 4 (pre-standard modes)

The following 2 basic board configurations are addressed with the same PCB and referred in the rest of the text as:

- Standard power: this configuration covers IEEE802.3af applications and it is based on flyback topology with diode rectification.
- High power: this configuration targets applications with output power in excess of the IEEE802.3af standard up to 20 W as output. This configuration is based on flyback topology with synchronous rectification. The same configuration can be used in PoE designs targeting high efficiency and/or with wide range auxiliary input (down to 12 V with prevalence of the auxiliary with respect to PoE).

2 Electrical specifications

Table 1. Specifications

Parameter	10 W	20 W
VIN	30 V to 60 V at 10 W output	30 V to 60 V at 20 W output
Auxiliary VIN AUXI	18 V to 60 V	18 V to 60 V
Auxiliary VIN AUXII	12 V to 60 V	12 V to 60 V
VOOUT	3.35 V +/- 100 mV at 3 A	3.35 V +/- 100 mV at 6 A
	5.05 V +/- 100 mV at 2 A	5.05 V +/- 100 mV at 4 A
Peak-to-peak output ripple	10 mVpp	20 mVpp
Efficiency DC-DC only	83% typ at 3.3 V 3 A	86% typ at 3.3 V 6 A
	87% typ at 5 V 2 A	88% typ at 5 V 4 A
Overall efficiency	78% typ at 3.3 V 3 A	81% typ at 3.3 V 6 A
	81% typ at 5 V 2 A	84% typ at 5 V 4 A
Switching frequency	250 kHz typ +/- 10%	250 kHz typ +/- 10%
Dynamic current step	1- 3 A max at 3.3 V	1- 6 A max at 3.3 V
	1- 2 A max at 5 V	1- 4 A max at 5 V
Maximum overshoot	200 mV	400 mV
Maximum overshoot time duration	200 ms	300 ms
Maximum undershoot	200 mV	400 mV
Maximum undershoot time duration	200 ms	300 ms
Maximum DC test current	3.5 A at 3.3 V	6.5 A at 3.3 V
	2.5 A at 5 V	4.5 A at 5 V
Minimum DC test current	0	0

3 Demonstration kit schematic

Figure 2. Demonstration kit schematic

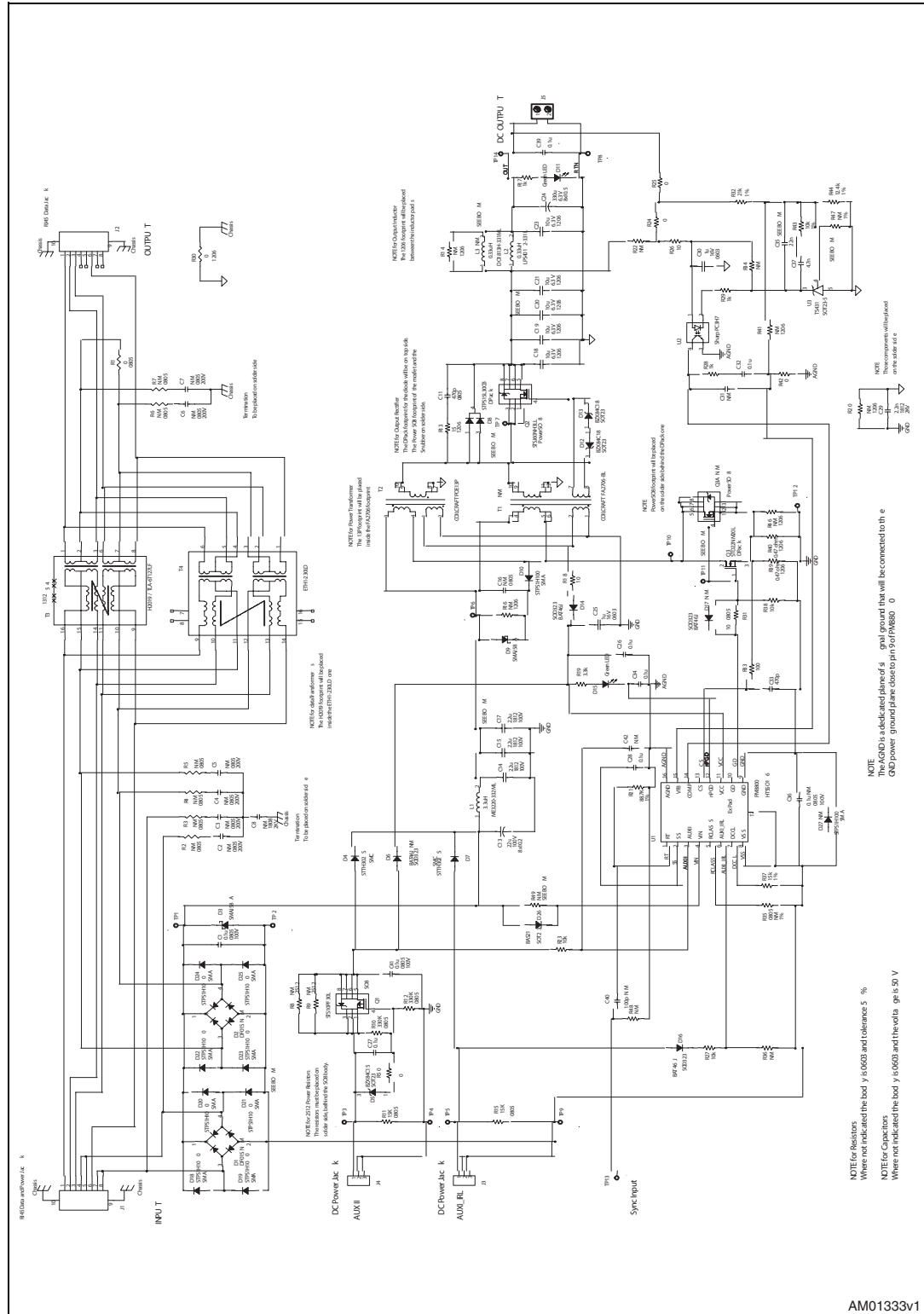

NOTE for Resistors
Where not indicated the body is 0603 and tolerance 5 %
NOTE for Capacitors
Where not indicated the body is 0603 and the voltage is 50 V

NOTE
The AGND is dedicated plane of ground that will be connected to the
GND power ground plane close to pin 9 of PM880 0

AM01333v1

4 Board layout

Figure 3. Assembly view: top and bottom layer

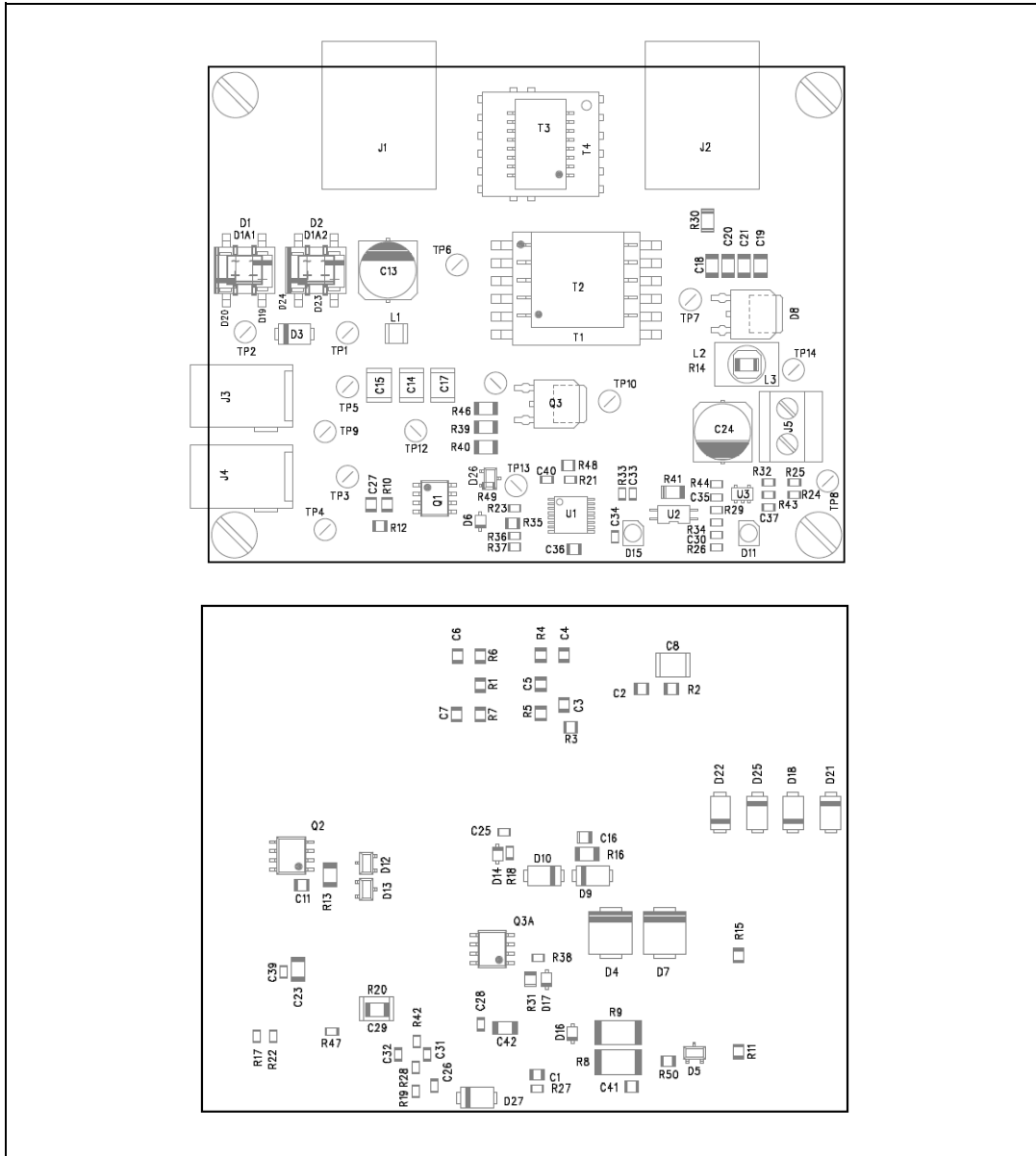

Figure 4. Top layer

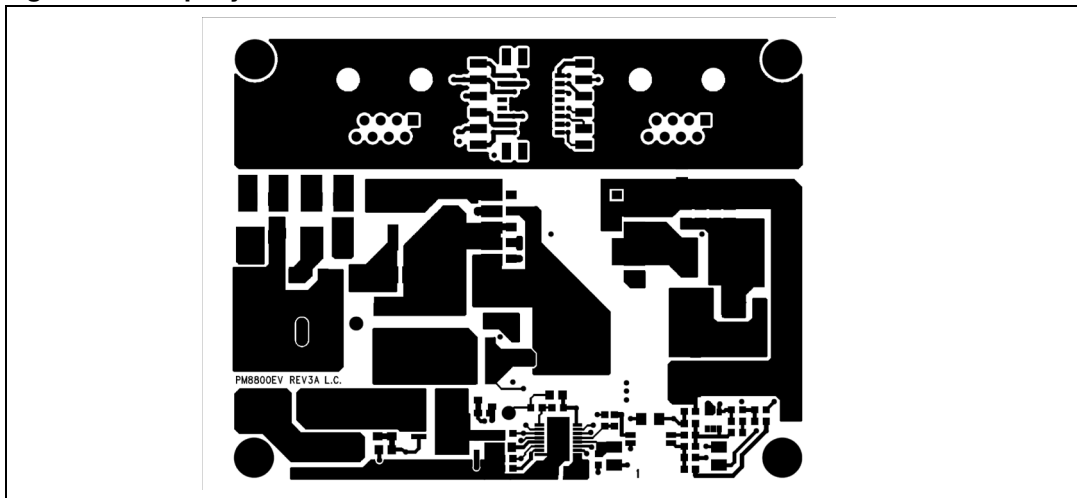

Figure 5. Inner layer 1

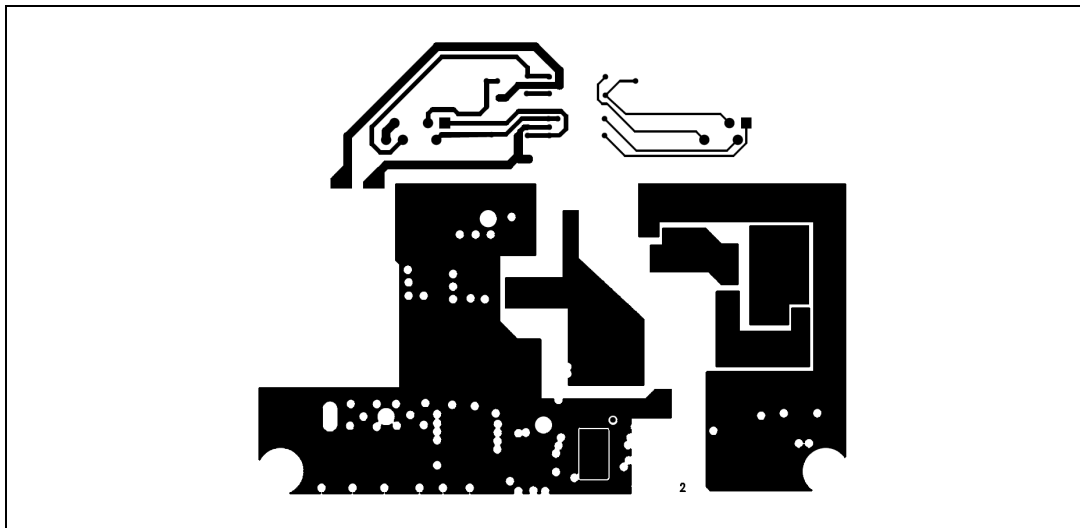

Figure 6. Inner layer 2

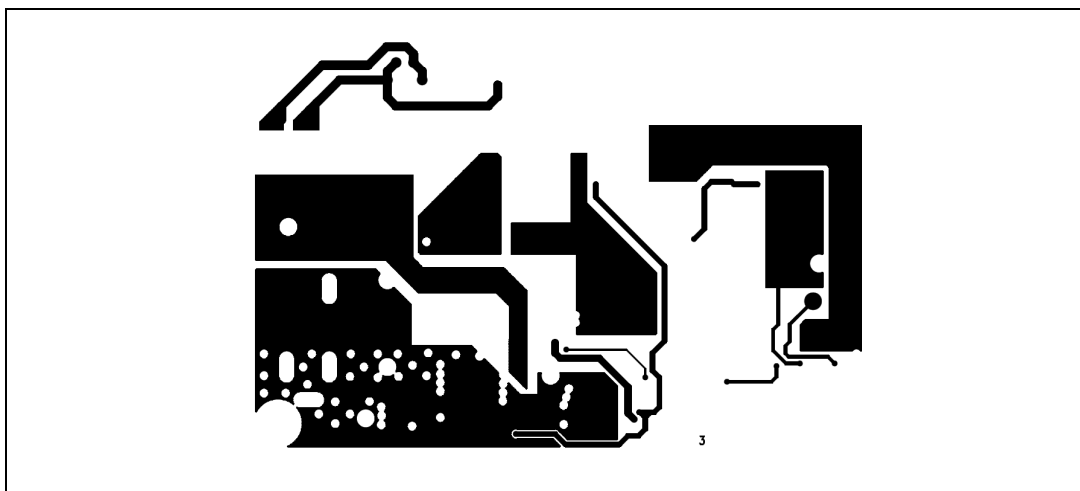
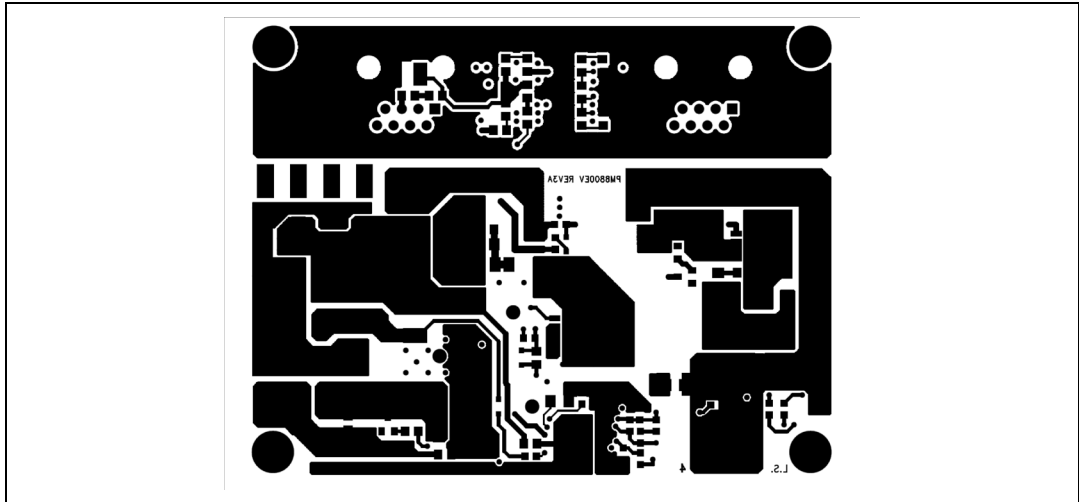

Figure 7. Bottom layer



4.1 Input/output connectors

In [Figure 3](#) the main input / output connections of the reference board are presented:

- J1 is the RJ45 connector for the PoE input, with data and power applied through the CAT5 cable (as an alternative, a positive voltage between 30 V and 60 V can be applied to test points TP1 + and TP2 -)
- J2 is the RJ45 data output
- J3 is the power jack for AUXI input (as an alternative, the test points TP 3 + and TP4 - can be used)
- J4 is the power jack for AUXII input (as an alternative, the test points TP5 + and TP9 - can be used)
- J5 is the DC output connector

4.2 Notes

- Please note that the use of TP1 and TP2 limits the voltage polarity applied and that these points are after the data transformer and diode bridges.
- AUXII is not protected against reverse polarity applied to it.
- For synchronization tests the capacitor C40 = 100 pF must be mounted. Please take care when using test point TP13 because this is a high impedance point that can easily pick up noise from the board.
- Resistive or electronic loads can be used as loads. Limit the output capacitance externally applied in order to not impact the loop compensation.
- As an input source a DC power supply with 60 V and 2 A capability is required.
- For auxiliary inputs a DC source of 60 V and 3 A capability is recommended.

5 Bill of material

Table 2. Components for the 4 isolated configurations possible with the PM8800

3.3 V std power	3.3 V high power	5 V std power	5 V high power	Reference	Description	Pkg	Manufacturer
Qty	Qty	Qty	Qty				
Printed circuit board							
1	1	1	1		PM8800 eval kit ⁽¹⁾		
Capacitors							
1	1	1	1	C1	Ceramic cap 0.1 µF 100 V	805	TDK
NM	NM	NM	NM	C36	Ceramic cap 0.1 µF 100 V	805	NM
NM	NM	NM	NM	C2, C7	Ceramic cap 200 V	805	NM
NM	NM	NM	NM	C8	Ceramic cap 2 kV	1812	NM
NM	NM	NM	NM	C9	Ceramic cap	805	NM
NM	NM	NM	NM	C10, C12	Ceramic cap	805	NM
1	1	1	1	C11	Ceramic cap 470 pF 50 V	805	Std
1	1	1	1	C13	Electrolytic cap 22 µF 100 V KX	8 x 10.2	SANYO
2	2	2	2	C14, C15	Ceramic cap 2.2 µF 100 V	1812	TDK
NM	1	NM	1	C17	Ceramic cap 2.2 µF 100 V	1812	TDK
NM	NM	NM	NM	C16	Ceramic cap	805	NM
2	2	NM	NM	C18, C19	Ceramic cap 10 µF 6.3 V	1206	TDK
3	3	NM	NM	C20, C21, C23	Ceramic cap 10 µF 6.3 V	1206	TDK
NM	NM	2	2	C18, C19	Ceramic cap 10 µF 16 V	1206	TDK
NM	NM	3	3	C20, C21, C23	Ceramic cap 10 µF 16 V	1206	TDK
NM	NM	NM	NM	C22, C38	Ceramic cap	1206	NM
1	1	1	1	C24	Electrolytic cap 330 µF 6.3 V EX	8 x 10.5	SANYO
2	2	2	2	C25, C30	Ceramic cap 1 µF 16 V	603	TDK
5	5	5	5	C26, C27, C28, C34, C39	Ceramic cap 0.1 µF 50 V	603	Std
1	1	1	1	C29	Ceramic cap 2.2 nF 2 kV	1812	TDK
NM	NM	NM	NM	C31	Ceramic cap	603	Std
1	1	1	1	C32	Ceramic cap 0.1 µF 50 V	603	Std

Table 2. Components for the 4 isolated configurations possible with the PM8800 (continued)

3.3 V std power	3.3 V high power	5 V std power	5 V high power	Reference	Description	Pkg	Manufacturer
Qty	Qty	Qty	Qty				
1	1	1	1	C33	Ceramic cap 470 pF 50 V	603	Std
1	NM	1	NM	C35	Ceramic cap 1 nF 50 V	603	Std
NM	1	NM	1	C35	Ceramic cap 22 nF 50 V	603	Std
1	1	1	1	C37	Ceramic cap 4.7 nF 50 V	603	Std
NM	NM	NM	NM	C40	Ceramic cap 100 pF 50 V	603	Std
1	1	1	1	C41	Ceramic cap 0.1 µF 100 V	805	TDK
Diodes							
NM	NM	NM	NM	D1, D2	Diode bridge DF01S	Dip	Diodes
2	NM	2	NM	D1A, D2A	Diode bridge HD01	MiniDip	Diodes
1	1	1	1	D3	Diode SMAJ58A	SMA	STMicroelectronics
2	2	2	2	D4, D7	Diode STTH302S	SMC	STMicroelectronics
1	1	1	1	D5	Diode Zener BZX84C15	SOT23	Std
NM	NM	NM	NM	D6	Diode BAT46J	SOT323	STMicroelectronics
1	NM	1	NM	D8	Diode STPS15L30CB	DPACK - TO252	STMicroelectronics
1	1	1	1	D9	Diode SMAJ40A	SMA	STMicroelectronics
1	1	1	1	D10	Diode STPR120A	SMA	STMicroelectronics
2	2	2	2	D11, D15	Diode green LED Toshiba TLGE1100B	SMD	Toshiba
2	2	2	2	D12, D13	Diode Zener BZX84C18	SOT23	Std
1	1	1	1	D14	Diode BAT46J	SOT323	STMicroelectronics
1	1	1	1	D16	Diode BAS316	SOT323	Std
NM	NM	NM	NM	D17	Diode BAT46J	SOT323	STMicroelectronics
NM	8	NM	8	D18 : D25	Diode STPS1H100A	SMA	STMicroelectronics
NM	1	NM	1	D26	Diode BAS316	SOT323	Std
NM	NM	NM	NM	D27	STPS1H100A	SMA	STMicroelectronics
Connectors							
2	2	2	2	J1, J2	Shielded RJ45 8-pole	THT	
2	2	2	2	J3, J4	DC power jack THT RAPC722	THT	
1	1	1	1	J5	DC power connector 2-pole	pitch 5.08	
Inductors							

Table 2. Components for the 4 isolated configurations possible with the PM8800 (continued)

3.3 V std power	3.3 V high power	5 V std power	5 V high power	Reference	Description	Pkg	Manufacturer
Qty	Qty	Qty	Qty				
1	1	1	1	L1	Inductor 3.3 μ H ME3220-332ML		Coilcraft
1	NM	1	NM	L2	Inductor 0.33 μ H LPS4012-331L		Coilcraft
NM	1	NM	1	L3	Inductor 0.33 μ H DO1813H-331ML		Coilcraft
MOSFETs							
1	1	1	1	Q1	Mosfet STS10PF30L	SO-8	STMicroelectronics
NM	1	NM	1	Q2	Mosfet STSJ60NH3LL	PowerSO-8	STMicroelectronics
1	NM	1	NM	Q3	Mosfet STD5N20L	DPACK - TO252	STMicroelectronics
NM	1	NM	1	Q3	Mosfet STD22NM20M	DPACK - TO252	STMicroelectronics
Resistors							
1	1	1	1	R1	Resistor chip 0 Ω	805	Std
NM	NM	NM	NM	R2:R7, R35	Resistor chip	805	Std
NM	NM	NM	NM	R8, R9	Resistor chip 2.2 Ω	2512	Std
2	2	2	2	R11, R15	Resistor chip 15 k Ω	805	Std
1	1	1	1	R10	Resistor chip 330 k Ω	805	Std
1	1	1	1	R12	Resistor chip 33 k Ω	805	Std
1	1	1	1	R13	Resistor chip 15 Ω	1206	Std
NM	NM	NM	NM	R14, R16, R20, R41	Resistor chip	1206	Std
1	1	1	1	R17	Resistor chip 1 k Ω	603	Std
1	1	1	1	R18	Resistor chip 10 Ω	603	Std
1	1	1	1	R19	Resistor chip 3K3	603	Std
1	1	1	1	R21	Resistor chip 88K7 1%	603	Std
NM	NM	NM	NM	R22, R34, R36	Resistor chip	603	Std
3	3	3	3	R23, R27, R38	Resistor chip 10 k Ω	603	Std
2	2	2	2	R24, R25	Resistor chip 0 Ω	603	Std
1	1	1	1	R26	Resistor chip 10 Ω	603	Std
1	1	1	1	R28	Resistor chip 1 k Ω	603	Std
1	1	1	1	R29	Resistor chip 1 k Ω	603	Std

Table 2. Components for the 4 isolated configurations possible with the PM8800 (continued)

3.3 V std power	3.3 V high power	5 V std power	5 V high power	Reference	Description	Pkg	Manufacturer
Qty	Qty	Qty	Qty				
1	1	1	1	R30	Resistor chip 0 Ω	1206	Std
1	1	1	1	R31	Resistor chip 10 Ω	805	Std
1	1	1	1	R32	Resistor chip 21 kΩ 1%	603	Std
1	1	1	1	R33	Resistor chip 100 Ω	603	Std
NM	1	NM	1	R37	Resistor chip 15 kΩ 1%	603	Std
2	2	2	2	R39, R40	Resistor chip 0R47	1206	Std
NM	NM	NM	NM	R20, R41	Resistor chip 0 Ω	1206	Std
1	1	1	1	R42	Resistor chip 0 Ω	603	Std
1	1	1	1	R43	Resistor chip 10 kΩ 1%	603	Std
1	1	1	1	R44	Resistor chip 12K4 1%	603	Std
NM	NM	NM	NM	R46	Resistor chip 0R47	1206	Std
NM	NM	1	1	R47	Resistor chip 15 kΩ 1%	603	Std
NM	NM	NM	NM	R48	Resistor chip 10 kΩ 1%	603	Std
1	NM	1	NM	R49	Resistor chip 0 Ω	603	Std
1	1	1	1	R50	Resistor chip 0 Ω	603	Std
Transformers							
NM	1	NM	NM	T1	Transformer EFD17 FA2706-BL		Coilcraft
NM	NM	NM	1	T1	Transformer EFD17 FA2707-BL		Coilcraft
1	NM	NM	NM	T2	Transformer EP13 PoE13P-33L		Coilcraft
NM	NM	1	NM	T2	Transformer EP13 PoE13P-50L		Coilcraft
1	NM	1	NM	T3	Transformer H2019 / TLA-6T127LF		Pulse/TDK
NM	1	NM	1	T4	Transformer ETH1-230LD		Coilcraft
13	13	13	13	TP1:TP13	Test point	5013	Keystone
ICs							
1	1	1	1	U1	PM8800	HTSSOP16	STMicroelectronics
1	1	1	1	U2	Optocoupler PC3H7		Sharp
1	1	1	1	U3	TSA431AILT	SOT23-5	STMicroelectronics

1. PM8800 demonstration kit printed circuit board has been manufactured with the following Cu layer thicknesses:

Layer 1, 4: 35 μm (1 oz.) (top / bottom side)

Layer 2, 3: 35 μm (1 oz.) (power plane)

6 Power-up sequence

It is recommended to apply power at the PoE input first, slowly increasing the voltage to verify the absence of abnormal input current levels.

From 1.5 V to 11.5 V input, the signature phase, the PM8800 presents a 24.5 k Ω nominal resistor as load.

After that in the range 11.5 V to 23 V, the classification phase, the PM8800 draws about 1.5 mA plus the current fixed with the classification resistance, if mounted.

After those two steps are verified, the voltage can be increased to 48 V typical.

Two green LEDs indicate proper operation of the PoE and DC/DC section of the PM8800 demonstration kit. D15 is the nPGD LED and is on when the internal hot-swap MOSFET is closed, while D11 indicates the presence of the output voltage.

7 Input section

7.1 Diode bridges

Two diode bridges are required at the input because PD must be able to accept voltage from an Ethernet cable with undefined polarity and coming from either Tx and Rx or spare pairs.

Diode bridges must be at least 0.5 A to 1 A, 100 V. They contribute to increasing the resistance presented by the PD to the PSE during the signature phase. For this reason the internal signature resistance is set to 24.5 kΩ. Care must be taken to not exceed the standard accepted values between 23.75 kΩ and 26.25 kΩ.

On the high-power board the diode bridges are replaced with discrete Schottky diodes, that due to the lower voltage drop, allow lower losses at high output power.

7.2 Input capacitors

The IEEE802.3af standard requires a capacitor whose values are between 50 nF to 120 nF during the signature phase and a minimum of 5 μF during the operating phase. A 100 nF, 100 V ceramic capacitor is used, placed near the VIN pin of PM8800.

In order to reduce the conducted emission, a C-L-C input filter has been designed with a 100 V aluminum capacitor at the input side, a 3.3 μH inductor and three 100 V ceramic capacitors on the output side.

The resonant frequency of the filter is:

Equation 1

$$F_{\text{req}} = \frac{1}{(2\pi \cdot \sqrt{L \cdot C_{\text{cer}}})}$$

It has been selected to be about 5-10 times above the control loop bandwidth, to not impact the stability of the control loop.

Equation 2

$$C_{\text{cer}} \geq \frac{I_{\text{prms}}}{(8 \cdot F_{\text{sw}} \cdot \Delta V_{\text{ripple}})}$$

7.3 Transient voltage suppression

The PD in some circumstances (ringing, overshoot transients, static electricity, ground differences, etc.) can see hundreds or thousands of volts at its RJ45 input connector. The energy associated with these voltages can be quite large.

A transient voltage suppressor (TVS) is typically applied at the input of the PD, after the diode bridge, in parallel to the 100 nF input capacitor.

The TVS must absorb this energy, but the PD interface must be designed to withstand an additional 20 V or 30 V above the operating range until the TVS limits the voltage.

The TVS must be selected with a standoff voltage higher than the maximum voltage of 57 V defined in the PoE standard which means a clamping voltage that can easily reach 100 V.

With the SMAJ58A the standoff is 58 V and the clamping voltage for a standard 10/1000 μ s transient is 93 V. PM8800 is able to withstand transient voltage up to 100 V without any damage.

8 PoE section

8.1 Signature

Signature is the first phase in the PoE standard and allows a PSE (power source equipment) to recognize the presence of a PD (powered device) that can accept power on the Ethernet cable.

The PM8800 integrates a 24.5 k Ω resistance to simplify a standard PoE PD interface design. Its value has been chosen to take into account the voltage drop across the diode bridge and its effect on the effective resistor value presented at the RJ45 connector input.

This resistor is disconnected for input voltages higher than 11.5 V.

The required signature capacitance is obtained with C1= 100 nF, 100 V.

8.2 Classification

Classification is the second phase in the PoE standard and allows the PSE to allocate the right amount of power for the PD connected on a single port.

The IEEE802.3af standard defines 4 power classes.

PM8800 has a dedicated pin for the classification resistor. The reference board has R35 left open, corresponding to CLASS 0.

To select a different class please refer to the table below:

Table 3. RCLASS resistor value

CLASS	PD power(W)	R _{CLASS} (Ω)	802.3af classification current (mA)	
			min.	max
0	0.44 - 12.95	Open	0	4
1	0.44 - 3.84	158	9	12
2	3.84 - 6.49	82.5	17	20
3	6.49 - 12.95	52.3	26	30
4	Reserved	36.5	36	44

To provide a constant current during the classification phase, PM8800 has an internal voltage regulator that maintains 1.4 V typ. across the classification resistor.

The value of R35 is calculated taking into account the power consumption of PM8800 during the classification phase, which is about 1.5 mA.

R35 is disconnected at the end of the classification phase, when the input voltage rises above 23 V.

8.3 UVLO and power-on

Power-on is the final state after successful detection and classification. The input voltage is increased and an internal switch is closed to connect the PD load. The inrush current is actively limited by the PM8800 itself.

The PM8800 is fully compliant with UVLO thresholds and inrush current limits defined in the IEEE802.3af standard.

8.4 Inrush current limit

The inrush current in PM8800 has a three-step limit depending on the voltage across the hot-swap MOSFET. The first two steps are fixed at 140 mA and 250 mA respectively, the last step has a default value of 440 mA and it is programmable.

The external resistor to select the desired inrush current is found with the following formula:

Equation 3

$$R_{IRL}[\text{k}\Omega] = \frac{11200}{I_{IRL}[\text{mA}]}$$

Figure 8. Inrush current limit vs. R_{IRL}

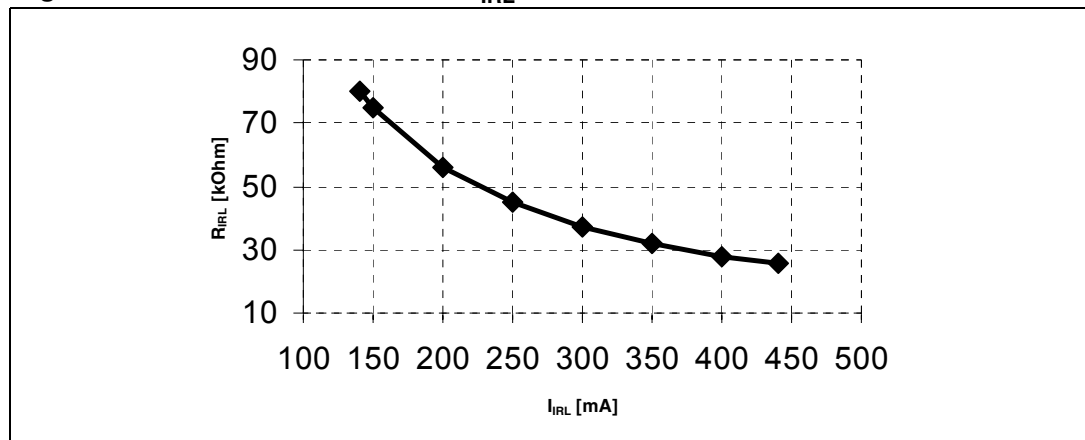

The PM8800 useful programming range for the inrush current limitation is between 140 and 440 mA. The practical resistor value ranges between 25 k Ω and 82 k Ω .

Depending on the application, attention must be given to the choice of the inrush current limit to avoid that the voltage drop on the external Ethernet cable causes UVLO conditions during the charging phase of the bulk capacitor.

It is recommended to select this voltage drop (can be estimated as max: 20 Ω x I inrush) to be lower than the UVLO hysteresis (7 V_{min}) in order to avoid hiccup turn-on.

The inrush current is set to the default three-step values when the AUX1 pin is pulled up over the 2 V internal threshold by an auxiliary voltage.

Programming inrush current limit resistor R38 on the PM8800 reference board is left open, thus the limits are set to the default values.

8.5 DC current limit

The continuous current limitation is internally set at 440 mA, but it is possible to modify it by connecting a resistor between DCCL and VSS. This limitation is active after setting nPGD, but in case the selected value is lower than the default inrush current, it also applies during the inrush current phase.

The formula to select the desired DC current is the following:

Equation 4

$$R_{DC}[k\Omega] = \frac{11200}{I_{DC}[mA]}$$

Figure 9. DC current limit vs. R_{DC}

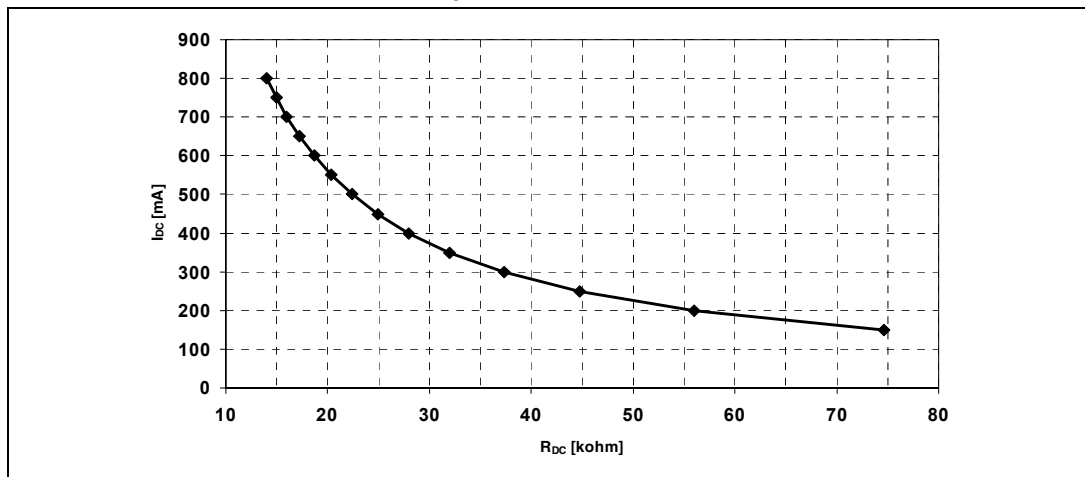

The PM8800 useful programming range for the DC current limitation is between 150 mA and 800 mA. The practical resistor value ranges between 15 k Ω and 75 k Ω .

Please note that the DC current limit is not linked to the inrush current limit, both limits can be set independently of each other.

Different current limits occur at different voltage drops between VSS and GND regardless of the PM8800 operative phase:

- For a drop < 3 V, the DC limit occurs with a default value of 440 mA
- For a drop > 3 V but < 15 V, the 3rd step of inrush current occurs with a default value of 440 mA
- For a drop > 15 V and < 30 V, the 2nd step of inrush current occurs with a default value of 250 mA
- For a drop > 30 V, the 1st step of inrush current occurs with a default value of 140 mA

We suggest putting the DC limit over the inrush current which allows avoiding an increase of current limiting during protection phases.

Programming DC current limit resistor R37 on the PM8800 standard reference board is left open, leaving the default value as the limit, while a 15 k Ω is mounted on the high-power version, putting the limit at 740 mA typ.

8.6 AUXI input

The PM8800 reference board accepts auxiliary power sources applied before the hot-swap MOSFET as low as 18 V (16 V seen at the pin VIN of device).

To do so and change the UVLO levels, the AUXI pin must be pulled up above 2 V with a current greater than 70 μ A.

The AUXI pin can be connected to the auxiliary voltage through a diode. In this case the current flowing into the pin is internally limited to about 300 μ A.

Depending on the output current drawn, the real operative AUXI voltage can be higher than the above mentioned value, basically due to the DC current limitation which is maximum input power at minimum applied on AUXI = 16V x 800 mA = 12.8 W.

Another limitation on the operative AUXI voltage can be the power transformer, not designed to work with a wide input voltage range for the maximum output power.

8.7 AUXII input

PM8800 can also accept auxiliary power sources applied after the hot-swap MOSFET as slow as 12 V (9 V seen at the pins of device). In this case there is no current limitation and an external circuit is recommended in order to limit the inrush current.

On the PM8800 reference board an active switch is implemented with a P-channel power MOSFET, capable of limiting the inrush current at startup and with very low ohmic drop during operation.

AUXII prevalence over PoE can be programmed forcing a current higher than 100 μ A in pin AUXII of PM8800. In this case the PD is always powered from AUXII power source because the interface circuits and the hot-swap MOSFET are forced in an off state. The pin can be connected to the auxiliary voltage through a diode. In this configuration the current flowing into the pin is internally limited to about 250 μ A. AUXII can be conveniently used in case of high-power PDs requiring input power higher than the 12.95 W specified in the IEEE802.3af standard.

Please note that having the hot-swap MOSFET in an off state means having the IC substrate in high impedance with GND. It is strongly recommended to move the signature capacitor of 100 nF from the C1 position to C36. This capacitor is placed between VSS and GND, implementing a low-impedance circuit at high frequency across the hot-swap MOSFET, assuring a good HF connection of the IC substrate. The PM8800 reference board is preset for AUXII prevalence over PoE, having R23 set to 10 k Ω .

Warning: In case of AUXII low input voltage sources, the condition $V_{IN} < V_{CC}$ must be avoided because of possible damage to the device.

9 Power transformer and operating input voltage

The PM8800 demonstration kit can contain two different types of power transformers:

Table 4. Characteristics of the power transformer for the PM8800 evaluation kit

Type	Lprimary	N	Ipeak sat	Rsec
PoE13P-33L / 50L	127 μ H	6 / 4	1 A	24 m Ω / 39 m Ω
FA2706-BL / 07-BL	70 μ H	6.8 / 4.85	3.5 A	8 m Ω / 18.5 m Ω

The standard EP13 transformer is designed to operate at full IEEE802.3af power when the input voltage is in the range 36-72 V. When working from auxiliary voltages lower than 36 V the output power must be reduced in order to not saturate the transformer.

The custom transformer has been designed to work optimally over the full input range between 12 V to 60 V in order to exploit the AUXII connection option made available by the PM8800.

FA2706/7-BL can be also used to draw more power than 10 W when restricting the input operational voltage range. For example about 20 W can be drawn with a minimum input voltage of about 30 V, the minimum operating voltage of the PoE standard range.

Figure 10. Output power vs. VAUXII

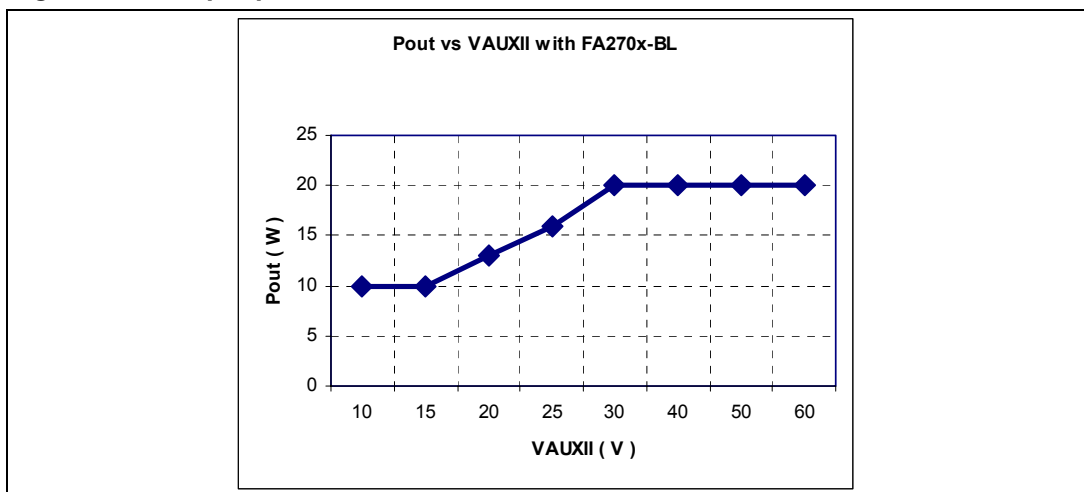

An auxiliary winding has been added in the FA2706/7-BL to directly drive a synchronous power MOSFET as a secondary rectifier, in order to reduce the power losses associated with a standard diode rectifier at high output currents.

When working at very low input voltage, as in the case of AUXII, the diode D6 can be added, (actually not mounted on the reference board) to directly supply the VCC pin of PM8800.

Warning: In this condition please do not increase the AUXII voltage above 15 V as permanent damage can occur to the device.

10 Power converter

The PM8800 reference board implements a flyback converter operating in DCM (discontinuous mode) at low output power and in CCM (continuous mode) for medium to high output power.

The output secondary rectifier can be a classic diode for low to medium output power or a synchronous rectifier for high output current.

Flyback configuration is the standard choice for a low-power isolated converter. It is the simplest isolated converter, using the lowest number of power components.

CCM has been selected in order to reduce the stress on the power components, especially on the secondary side.

CCM is assured only at medium to full output power, while in low output power the converter works in DCM which allows reducing the size of the power transformer.

It is out of the scope of this document to show the whole flyback converter theory, which can be found in every basic power supply handbook. In this application note we focus only on the aspects directly related to the use of the PM8800 in a flyback converter.

10.1 Flyback continuous conduction mode

The flyback converter is in DCM when the energy stored during the ON phase has been completely transferred to the secondary side during the OFF phase. This means that a small period of time still remains during which no current is flowing on either side of the power transformer.

When this period of time does not exist, i.e. when the energy stored has not been completely transferred during the ON phase, the flyback is said to work in CCM.

Compared to CCM, DCM presents higher peak and rms current values on the primary switch and on the output rectifier. This implies higher output ripple and require bigger input and output filters.

CCM presents an RHP zero, which slightly complicates the control loop compensation. A flyback converter designed to work in CCM is also stable in DCM.

The transfer function of a flyback in CCM is:

Equation 5

$$(V_{in} - V_{ds}) \cdot T_{on} = (V_{out} + V_d) \cdot N \cdot (T_{sw} - T_{on})$$

The above equation can be written as:

Equation 6

$$\frac{(V_{out} + V_d)}{(V_{in} - V_{ds})} = \frac{D}{N \cdot (1 - D)}$$

The maximum duty cycle can be obtained as:

Equation 7

$$\frac{T_{on_max}}{T_{sw}} = \frac{N \cdot (V_{out} + V_d)}{(V_{in_min} - V_{ds}) + N \cdot (V_{out} + V_d)}$$

10.2 Main switch current and current sensing

The current shape in the primary power switch is different when the flyback converter is working in DCM or CCM. In DCM the shape is triangular with the current starting from zero, while in CCM the shape is trapezoidal.

For CCM operations the peak current can be computed as:

Equation 8

$$I_{peak} = I_{pave} + \frac{\Delta I_L}{2} = \frac{I_{out}}{\eta \cdot N \cdot (1 - D_{max})} + \frac{V_{in_max} \cdot D_{max} \cdot T_{sw}}{2L_p}$$

which can be expressed as:

Equation 9

$$I_{peak} = \frac{P_{out}}{\eta \cdot D_{max} \cdot (V_{in} - V_{ds})} + \frac{V_{in_max} \cdot D_{max} \cdot T_{sw}}{2L_p}$$

The RMS current can be:

Equation 10

$$I_{prms} = \sqrt{D_{max} \cdot \left[I_{peak}^2 - \left(I_{peak} \cdot \frac{\Delta I_L}{2} + \frac{\Delta I_L^2}{3} \right) \right]}$$

The above formula can be used to calculate the right current sense resistor, taking into account that the first level of OCP is for PM8800 at 500 mV:

Equation 11

$$R_{cs} = \frac{500mV}{1.3 \cdot I_{peak}}$$

The associated power dissipation on the sense resistor is:

Equation 12

$$P_{cs} = R_{cs} \cdot I_{prms}^2$$

10.3 Main switch power dissipation

The power dissipation on the main power MOSFET is the sum of two terms:

Equation 13

$$P_{\text{cond}} = R_{\text{on}} \cdot I_{\text{prms}}^2 \cdot D_{\text{max}}$$

$$P_{\text{switching}} = \frac{C_{\text{oss}} \cdot V_{\text{ds}}^2 \cdot F_{\text{sw}}}{2} + V_{\text{ds}_{\text{max}}} \cdot I_{\text{peak}} \cdot T_{\text{m}} \cdot F_{\text{sw}}$$

where

Equation 14

$$V_{\text{ds}_{\text{max}}} = 1.2 \cdot [(V_{\text{in}_{\text{max}}} + V_{\text{spike}}) + N \cdot (V_{\text{out}} + V_{\text{d}})]$$

V_{spike} is due to the leakage inductance of the power transformer and can be assumed to be 40 V max, as the snubber network on the primary side is built with a TVS with breakdown voltage of 40 V.

T_{m} is the time to charge the Miller capacitor of the power MOSFET and can be estimated as:

Equation 15

$$T_{\text{m}} = \frac{Q_{\text{gd}} \cdot R_{\text{g}}}{V_{\text{cc}} - V_{\text{gsth}}}$$

Note that if the major contribution to the MOSFET losses comes from the second term of the switching power losses, the right choice is for a low gate charge power MOSFET.

10.4 Rectifier diode dissipation

The secondary output current is:

Equation 16

$$I_{\text{peak}} = I_{\text{save}} + \frac{\Delta I_{\text{SL}}}{2} = \frac{I_{\text{out}_{\text{max}}}}{1 - D_{\text{max}}} + \frac{[(V_{\text{out}} + V_{\text{d}}) \cdot (T_{\text{sw}} - T_{\text{on}})]}{(L_{\text{p}})/N^2}$$

$$I_{\text{rms}} = \sqrt{(1 - D_{\text{max}}) \cdot \left[I_{\text{peak}}^2 - I_{\text{peak}} \cdot \Delta I_{\text{SL}} + \frac{\Delta I_{\text{SL}}^2}{3} \right]}$$

The reverse voltage across the rectification diode is:

Equation 17

$$V_{\text{r}_{\text{diode}}} = \frac{V_{\text{in}_{\text{max}}}}{N} + V_{\text{out}}$$

The power dissipated in the secondary diode, neglecting the reverse leakage losses, can be estimated as:

Equation 18

$$P_{\text{diode}} = I_{\text{rms}} \cdot V_{\text{d}} \cdot (1 - D_{\text{max}})$$

10.5 PM8800 internal power dissipation

A calculation must be done to verify that the PM8800 maximum junction temperature has not been exceeded.

Major contributions to internal power dissipation are:

- startup circuit
- power MOSFET gate driver
- hot-swap MOSFET
- internal circuitry

It is strongly recommended to use an additional winding to generate an auxiliary VCC voltage of 9 V minimum, which switches off the internal startup circuit after the power-up of the converter.

As mentioned before, the converter power MOSFET must be chosen as a good compromise between low R_{on} and low total charge. The internal power dissipation associated to the gate drive is:

Equation 19

$$P_{drive} = V_{cc} \cdot Q_g \cdot Freq$$

The hot-swap MOSFET dissipates internally:

Equation 20

$$P_{hotswap} = R_{on} \cdot I_{in}^2$$

Internal power dissipation is due to circuits that draw current directly from VIN, like the hot-swap controller or other logic circuits powered from VCC:

Equation 21

$$P_{device} = V_{in} \cdot I_{in} + V_{cc} \cdot I_{logic}$$

Typical operative values are $I_{in} = 5 \text{ mA}$ and $I_{logic} = 3 \text{ mA}$.

The total power dissipated by PM8800 is:

Equation 22

$$P_{tot} = P_{drive} + P_{hotswap} + P_{device}$$

The following relationship must be satisfied:

Equation 23

$$T_{amb} + P_{tot} \cdot R_{thja} < T_{jmax}$$

where a typical value of R_{th} for PM8800 mounted on the ref board is $85 \text{ }^\circ\text{C/W}$ and T_{jmax} is $150 \text{ }^\circ\text{C}$.

11 Layout guidelines

We suggest the following guidelines for the layout of the PM8800:

- Place the component group including input ceramic capacitors, input side of transformer, power MOSFET and sense resistors close to each other in order to keep the interconnections as short as possible.
- Place the component group including secondary rectifier diode, output side of transformer, output ceramic capacitors close to each other in order to keep the interconnections as short as possible.
- Place the PM8800 in such a way as to have a short path to the gate of the power MOSFET. Use a 20-30 mils wide path for this signal.
- Ground: there are basically 4 different grounds on the board (VSS, GND, RTN and chassis ground).
 - The exposed pad of PM8800 must be connected to VSS. Design a fill area with at least 6 vias to the VSS plane. Try where possible to increase the number of VSS power planes connected, at least below the PM8800 position, to improve the heat dissipation of PM8800.
 - GND must be divided into power gnd (to connect input caps, Rsense, PM8800 pin 9, AUXII circuitry, isolation cap) and signal gnd (to connect the other components around the PM8800, the circuitry powered by VCC voltage, and the IC pin 16). The signal gnd must be connected to power gnd in one point only, close to the PM8800 pin 9. Keep the power path on RTN (output side of transformer, secondary diode, output connector) separated from the feedback network gnd, which is connected only at the connector side.
- Design the power MOSFET area with at least 9-12 vias of connection to the internal copper area. Try where possible to increase the number of power planes connected, at least below the MOSFET position, to improve the heat dissipation.
- Design the secondary rectifier diode with at least 9-12 vias of connection to the internal copper area.
- Try where possible to increase the number of power planes connected, at least below the diode position, to improve the heat dissipation.
- Chassis: design copper areas on both side of the PCB. Do not place other grounds or signals under the RJ45 and the data transformer area. Place any termination network on the bottom side.

More in detail:

Place the TVS close to the input diode bridges, if possible on the same side

1. Place the PM8800 and all the related components close to each other, use both sides
2. Place all the feedback components close to each other, use both sides
3. Place the sense resistors close to the power MOSFET, if possible on the same side
4. Place the input ceramic capacitors close to the input side of power transformer, if possible on the same side
5. Place the primary snubber network close to the power transformer, on the bottom side
6. Place the rectifier diode close to the output side of the transformer, if possible on the same side
7. Place the secondary snubber network close to the rectifier diode, bottom side
8. Place the output ceramic capacitors close to the rectifier diode and the power transformer, on the copper areas, top side
9. Place the last ceramic capacitors close to the output terminal of the power connector, bottom side
10. Place the 100 nF input capacitor close to the VSS and GND pins
11. Place the decoupling capacitors for VCC close to the relevant PM8800 pin
12. Place the components for RT and SS pins in a quiet area, separated as much as possible from other signals
13. Use paths of at least 20 mils for signals connected to the IC pins 5,10,11
14. Connect the PM8800 pins 8,9,16 directly to the copper areas
15. Use a wide path or copper area for VIN, AUXI and AUXII networks

12 Test results

12.1 Efficiency measurements

Figure 11. 5 V out - standard board with diode rectification

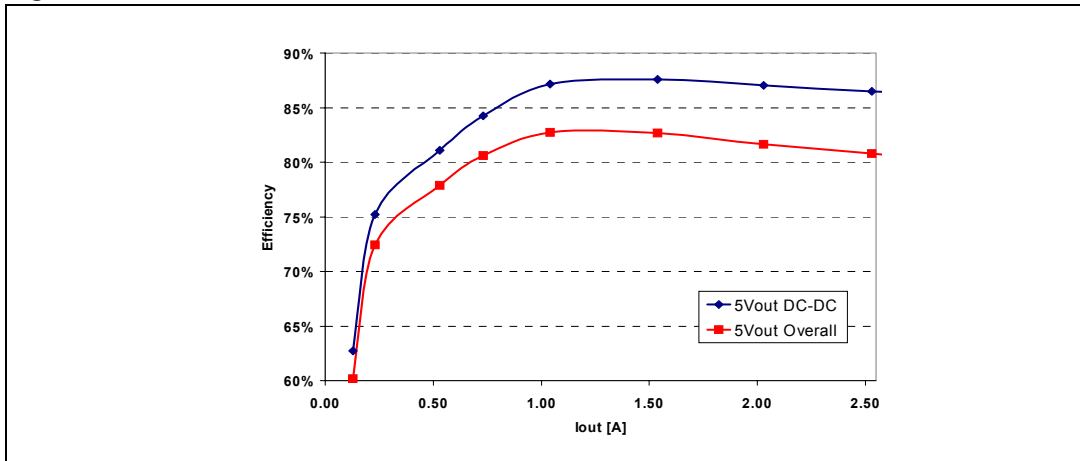

Figure 12. 5 V out - high-power board with synchronous rectification

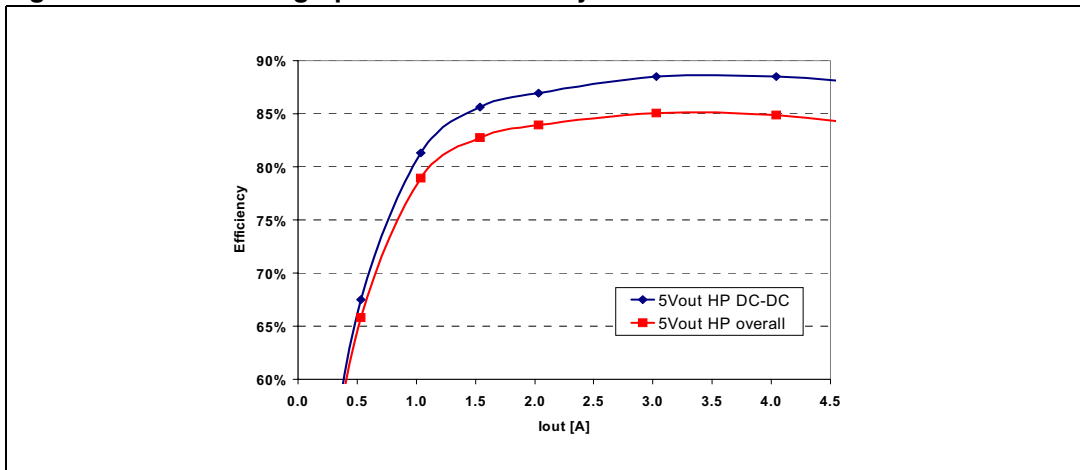

Figure 13. 3.3 V out - standard board with diode rectification

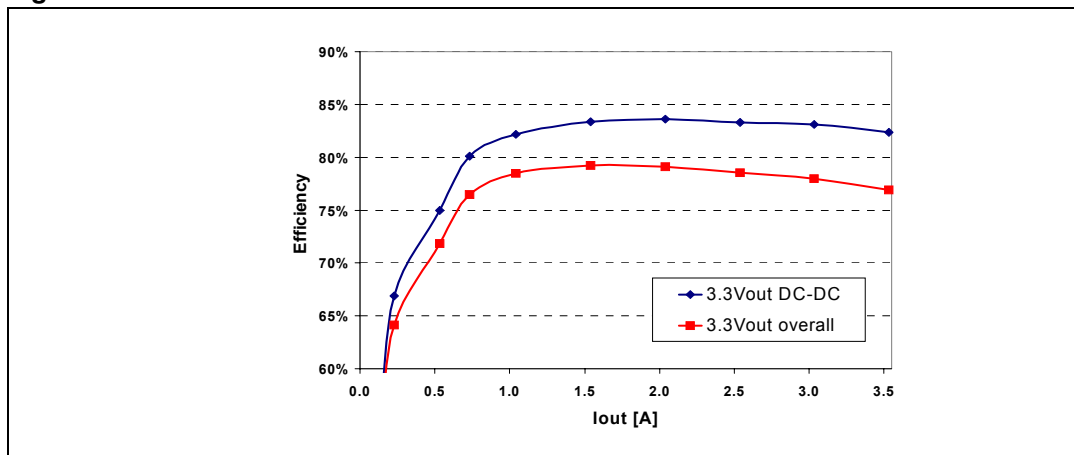
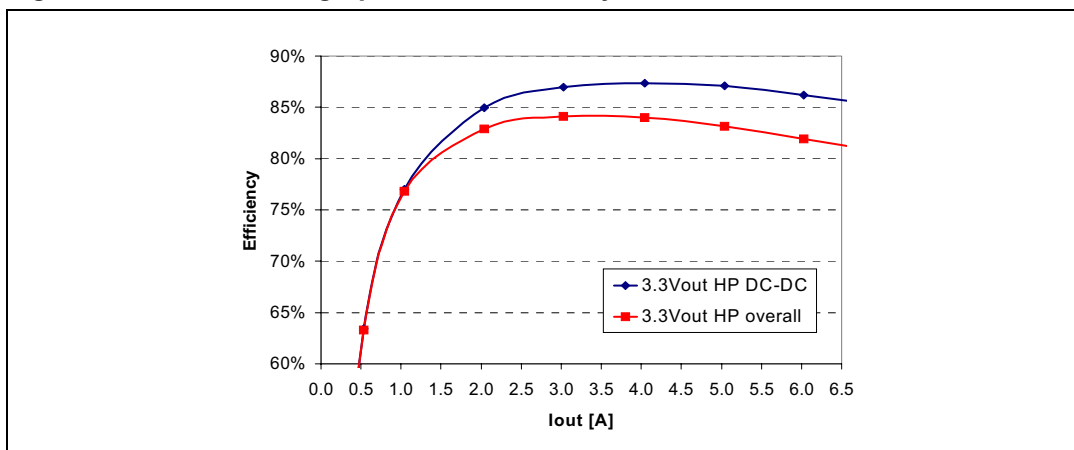

Figure 14. 3.3 V out - high-power board with synchronous rectification



In the following pages are shown tests done on the 5 V high-power version and 3.3 V standard version of the reference board.

Similar results and behaviors could be obtained with the 3.3 V high-power version and 5 V standard versions.

12.2 5 V high-power board measurements

Figure 15. Startup of the PM8800 demonstration kit with 5 V 1 A

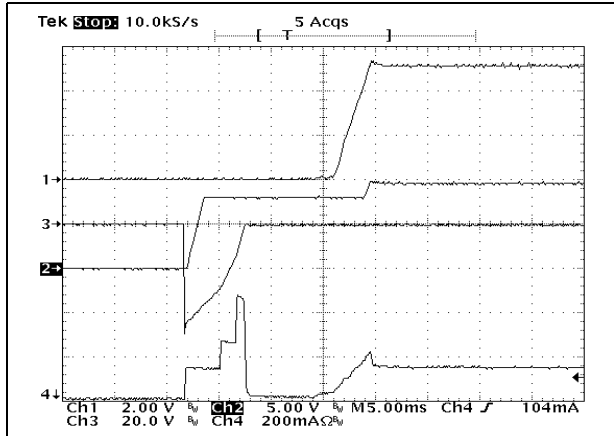
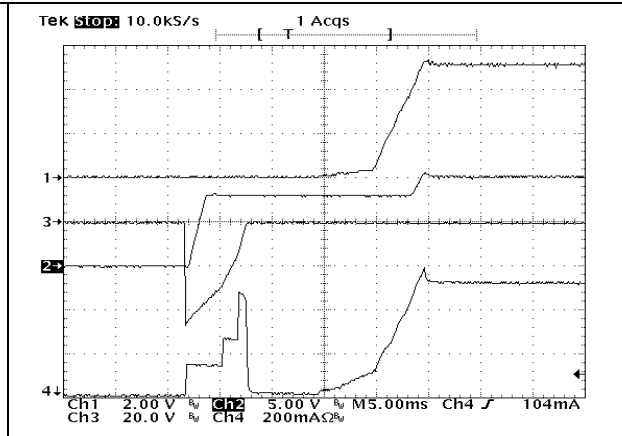

Figure 16. Startup of the PM8800 demonstration kit with 5 V 4 A



Ch1= output voltage, Ch2 = VSS voltage with respect to GND, Ch3 = VCC voltage, Ch4 = input current

Figure 17. Details of the inrush phase

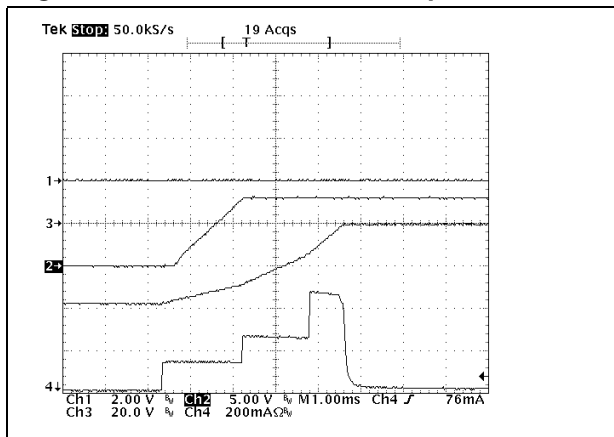
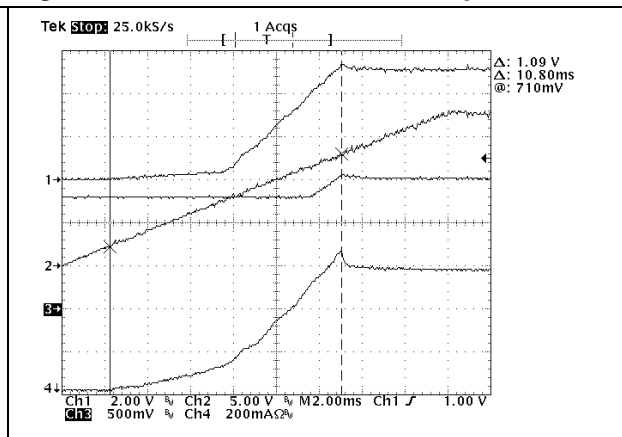

Figure 18. Details of the soft-start phase



Ch1= output voltage, Ch2 = VSS voltage with respect to GND, Ch3 = VCC voltage (left) and soft-start (right), Ch4 = input current.

Figure 19. V_{DS} and V_{GS} of the primary MOSFET for 5 V 1 A

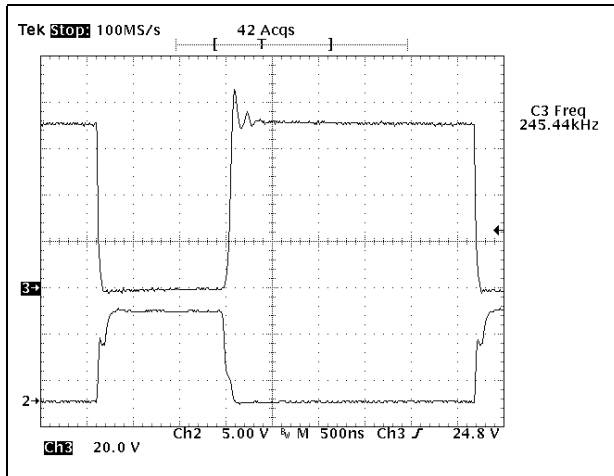
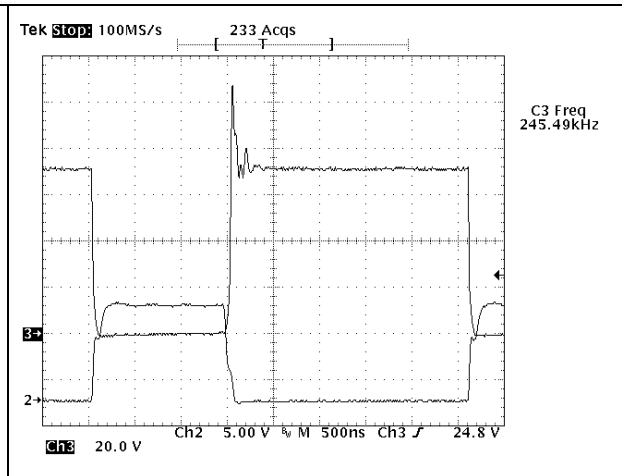
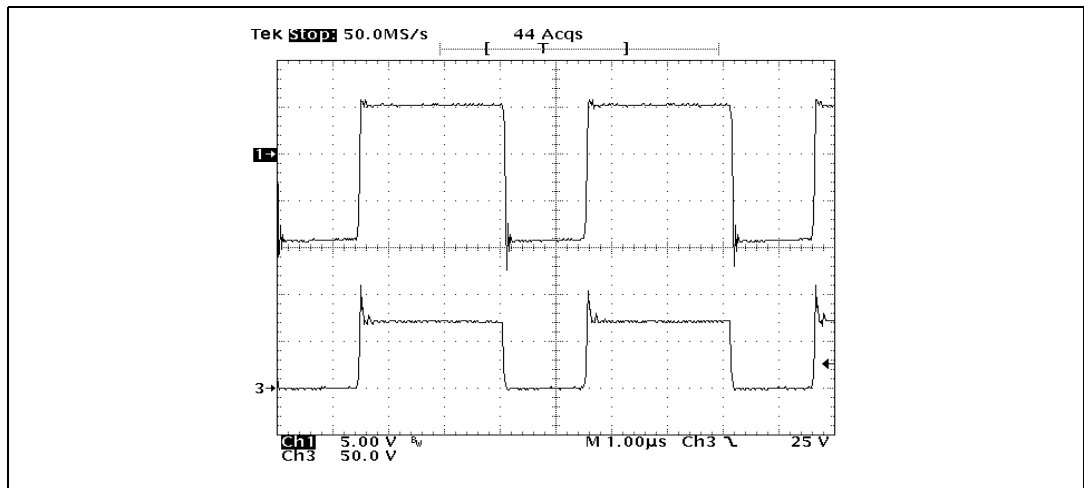

Figure 20. V_{DS} and V_{GS} of the primary MOSFET for 5 V 4 A



Ch2 = primary side power MOSFET gate voltage, Ch3 = primary side power MOSFET drain voltage.

Figure 21. Details of the synchronous rectifier MOSFET voltage with 48 V and 4 A out



Ch1 = secondary side power MOSFET drain-source voltage, Ch3 = primary side power MOSFET drain voltage

Figure 22. Output voltage ripple at 4 A output current

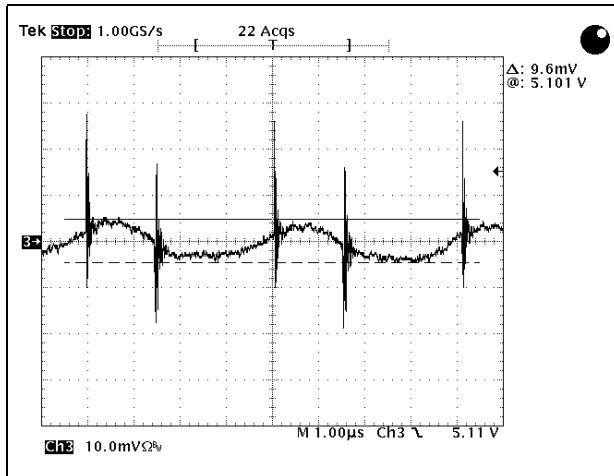

Figure 23. Output voltage ripple at 4 A output current (1 sec persistence)

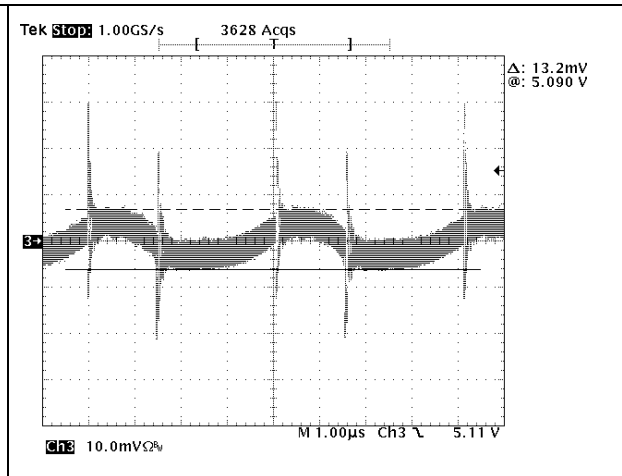

Figure 24. Dynamic load 1 A to 4 A: output voltage (up) and output current (down)

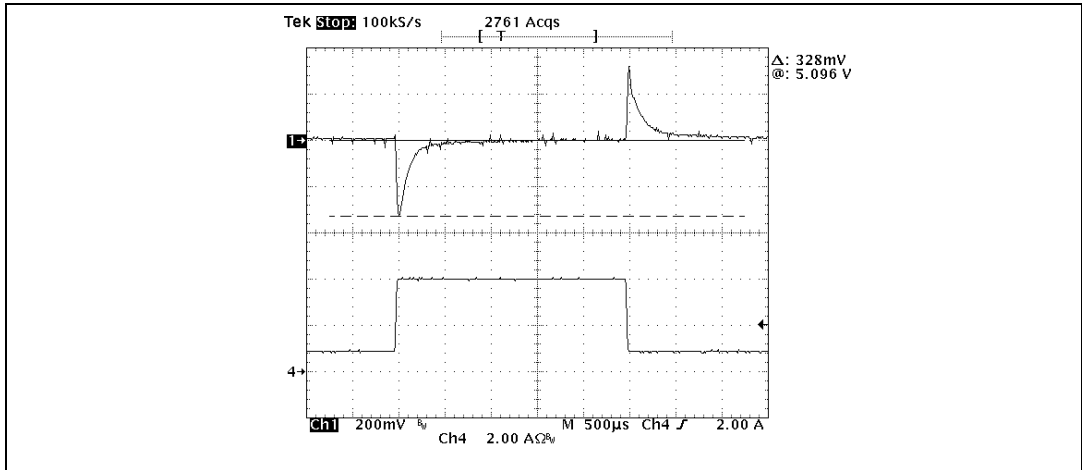

Figure 25. PM8800A response to a 6 A overload condition

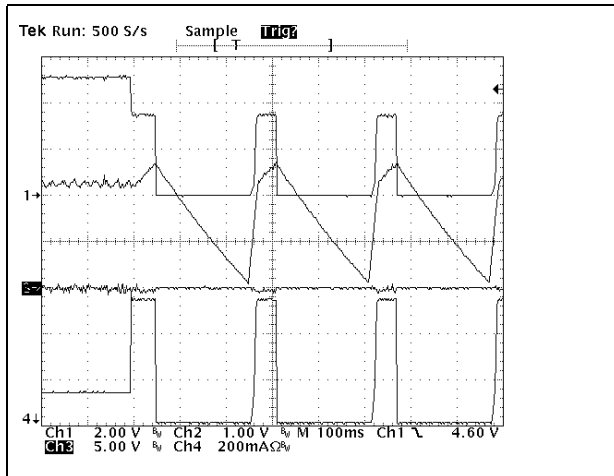
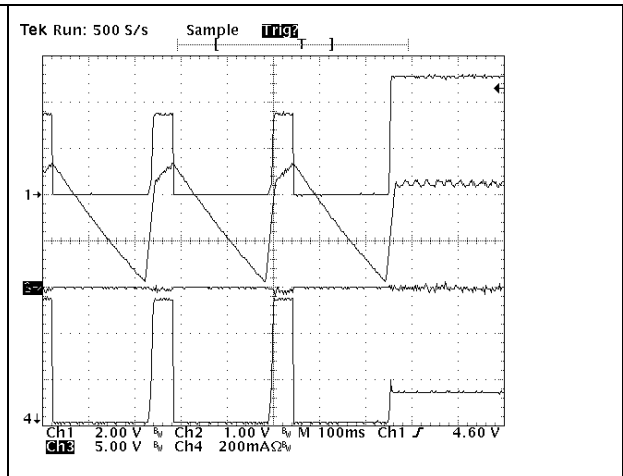

Figure 26. PM8800A recovering from a 6 A overload condition



Ch1 = output voltage, Ch2 = soft-start voltage, Ch3 = voltage across the hot-swap MOSFET, Ch4 = input current.

Figure 27. PM8800A response to a short on the load

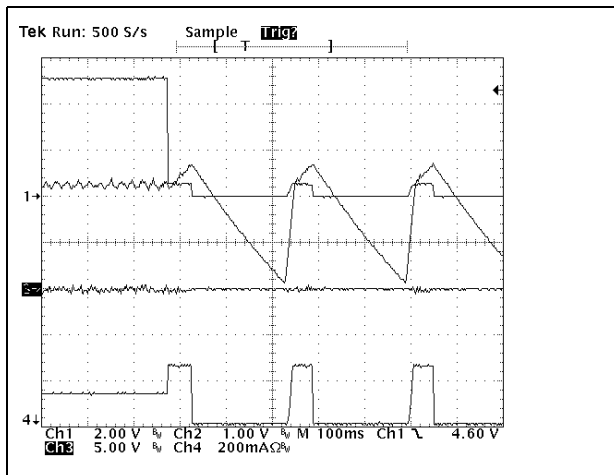
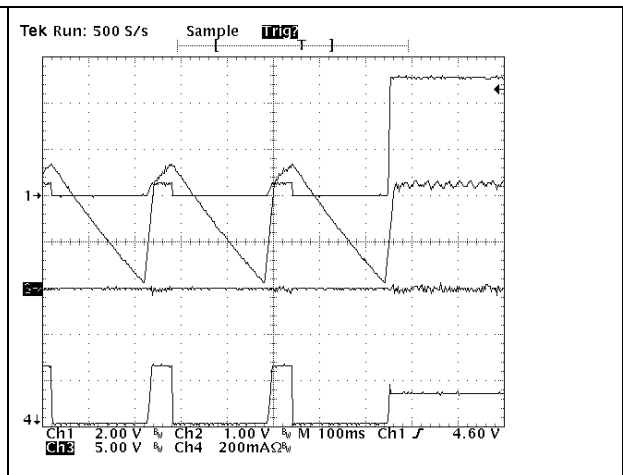
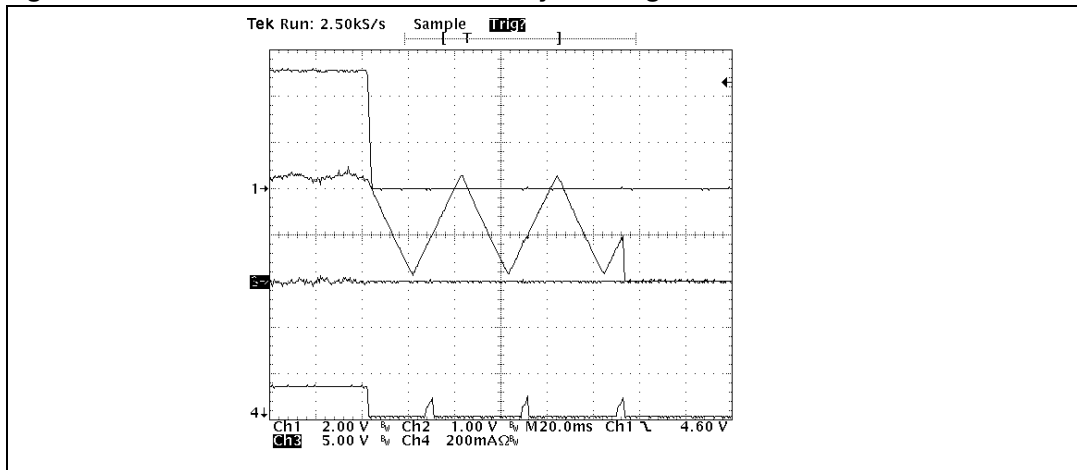

Figure 28. PM8800A recovering from a short on the load



Ch1 = output voltage, Ch2 = soft-start voltage, Ch3 = voltage across the hot-swap MOSFET, Ch4 = input current.

Figure 29. Internal short on the secondary winding



Ch1 = output voltage, Ch2 = soft-start voltage, Ch3 = voltage across the hot-swap MOSFET, Ch4 = input current

Figure 30. Switch between 48 V PoE and 24 V AUXII with 5 V at 2 A **Figure 31. back to 48 V removing the 24 V AUXII voltage with 5 V at 2 A**

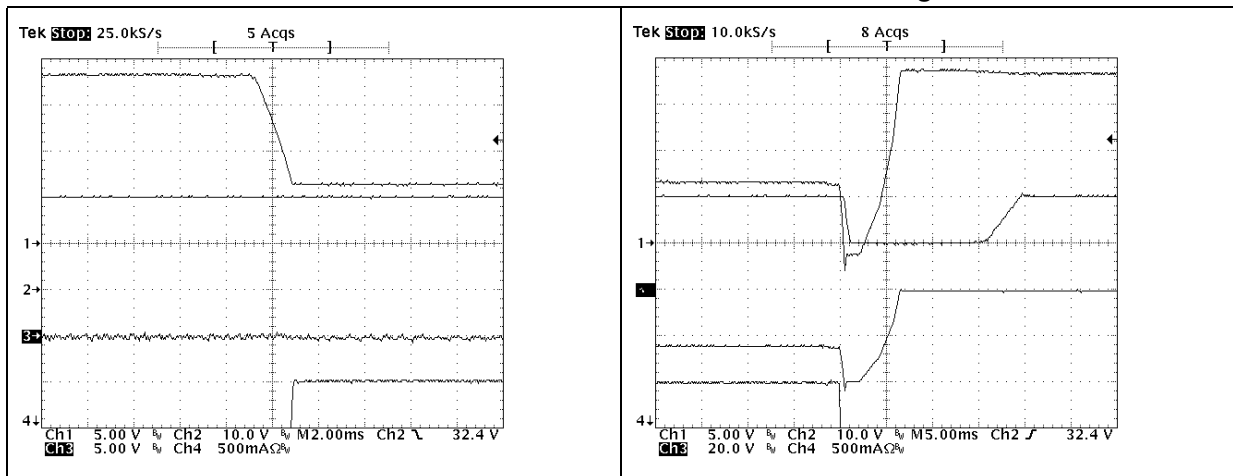

Ch1 = output voltage, Ch2 = internal primary voltage, Ch3 = voltage across the hot-swap MOSFET, Ch4 = AUXII input current

Figure 32. Switch between 48 V PoE and 12 V AUXII with 5 V at 2 A

Figure 33. Back to 48 V removing the 12 V AUXII voltage with 5 V at 2 A

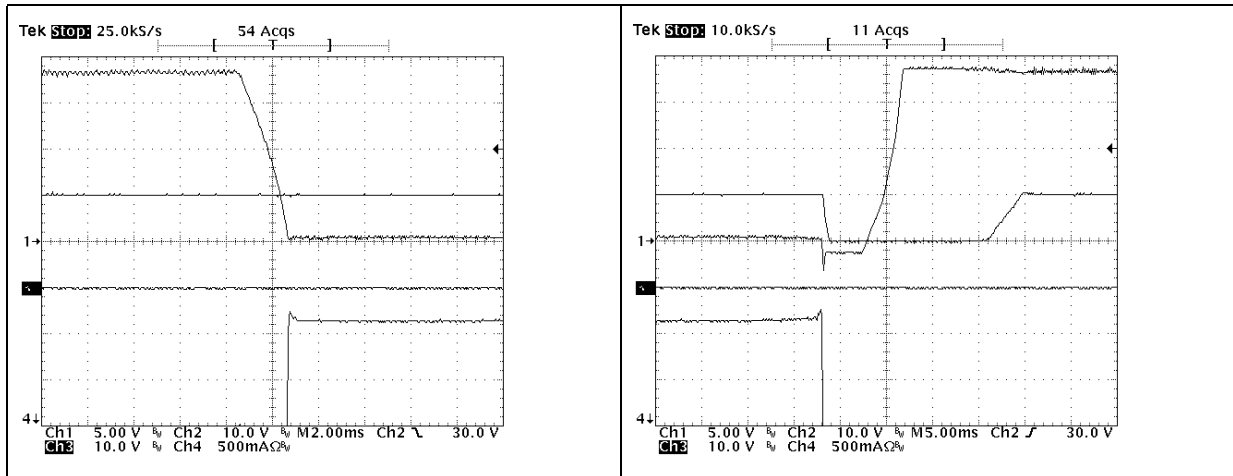

Ch1 = output voltage, Ch2 = internal primary voltage, Ch3 = voltage across the hot-swap MOSFET, Ch4 = AUXII input current

12.3 3.3 V standard-power board measurements

Figure 34. Startup of the PM8800 demonstration kit with 3.3 V, 1 A

Figure 35. Startup of the PM8800 demonstration kit with 3.3 V, 3 A

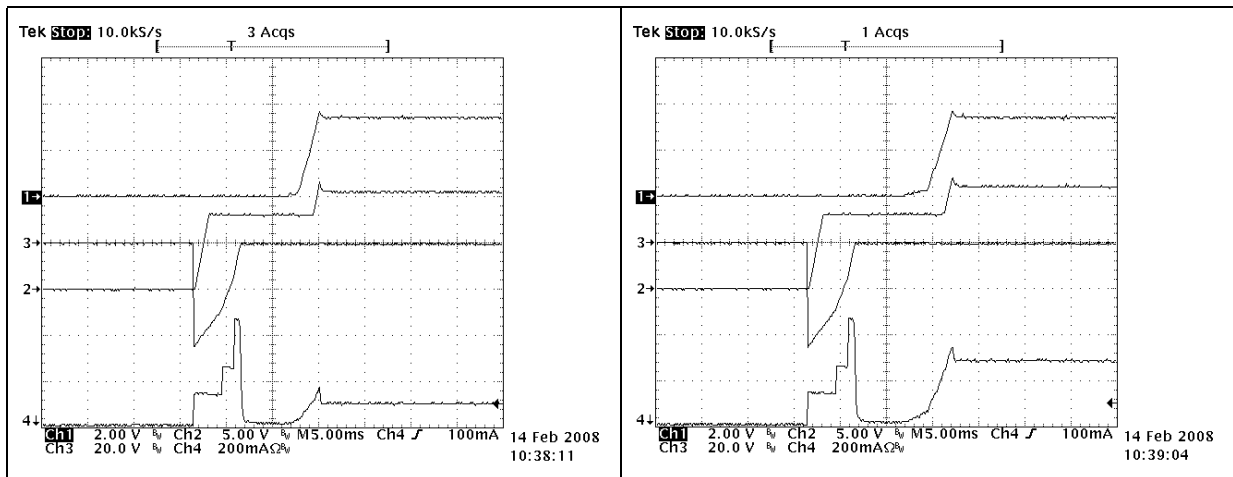

Ch1= output voltage, Ch2 = VSS voltage with respect to GND, Ch3 = VCC voltage, Ch4 = input current

Figure 36. Details of the inrush phase

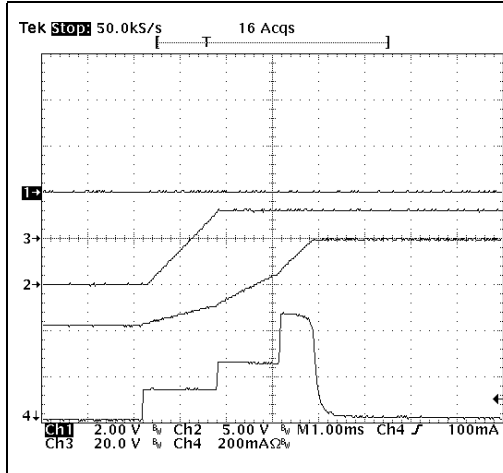
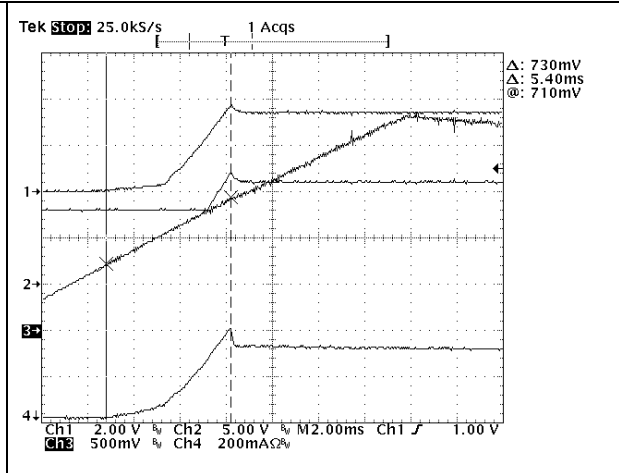

Figure 37. Details of the soft-start phase



Ch1= output voltage, Ch2 = VSS voltage with respect to GND, Ch3 = VCC voltage (left) and soft-start (right), Ch4 = input current

Figure 38. V_{DS} and V_{GS} of the primary MOSFET for 3.3 V 1 A

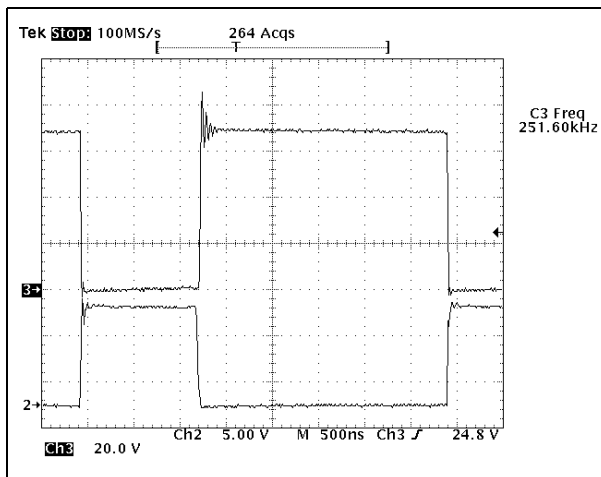
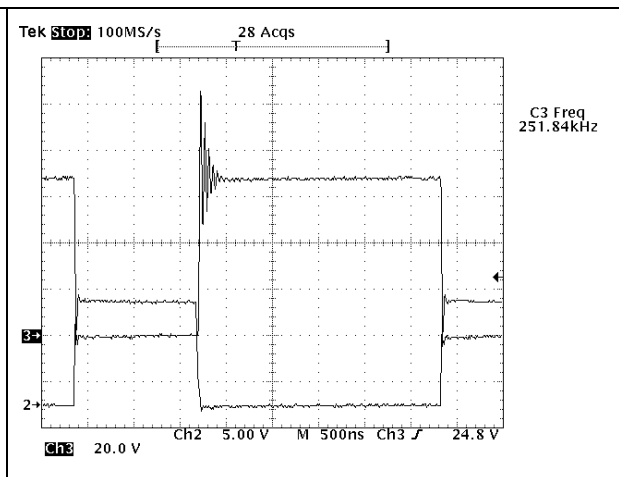
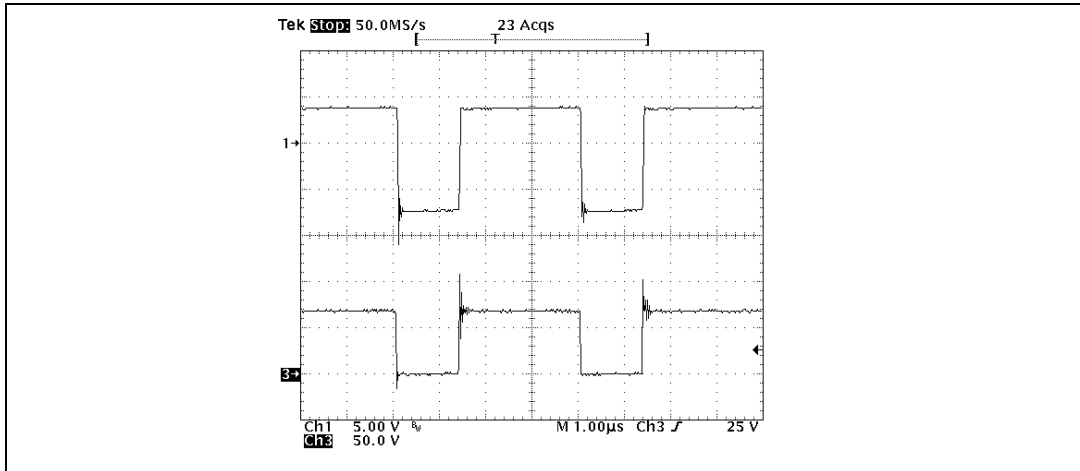

Figure 39. V_{DS} and V_{GS} of the primary MOSFET for 3.3 V 3 A



Ch2 = primary side power MOSFET gate voltage, Ch3 = primary side power MOSFET drain voltage

Figure 40. Details of the synchronous rectifier MOSFET voltage with 48 V and 3 A output current



Ch1 = secondary side power MOSFET drain-source voltage, Ch3 = primary side power MOSFET drain voltage

Figure 41. Output voltage ripple at 3 A output current

Figure 42. Output voltage ripple at 3 A output current (1 sec persistence)

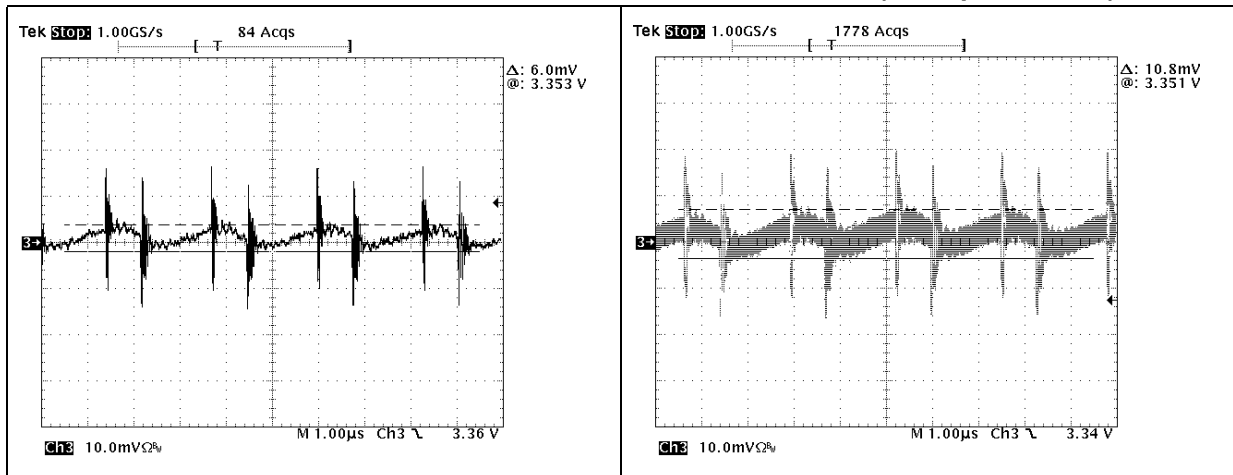

Figure 43. Dynamic load 1 to 3 A: output voltage (up) and output current (down)

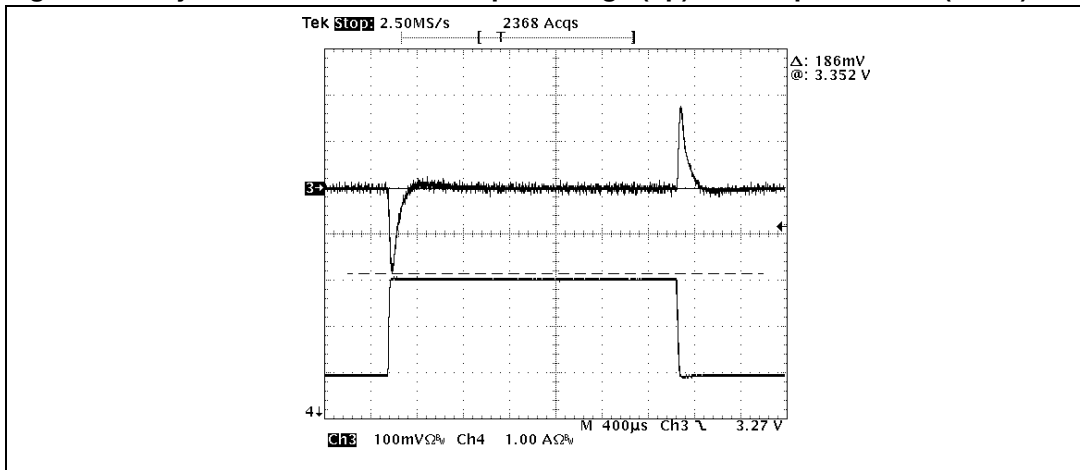

Figure 44. PM8800A response to a 5 A overload condition

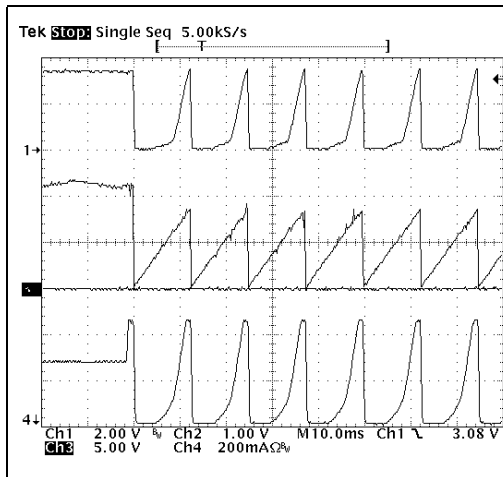
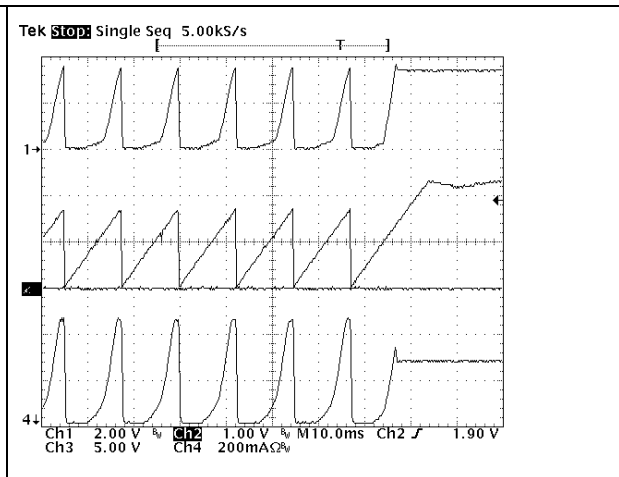

Figure 45. PM8800A recovering from a 5 A overload condition



Ch1 = output voltage, Ch2 = soft-start voltage, Ch3 = voltage across the hot-swap MOSFET, Ch4 = input current

Figure 46. PM8800A response to a short on the load

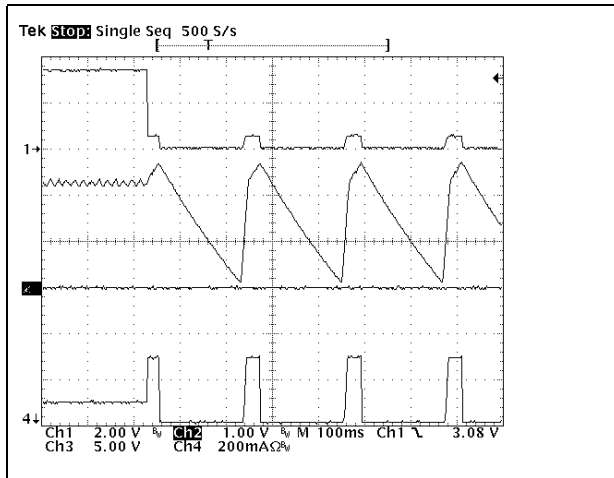
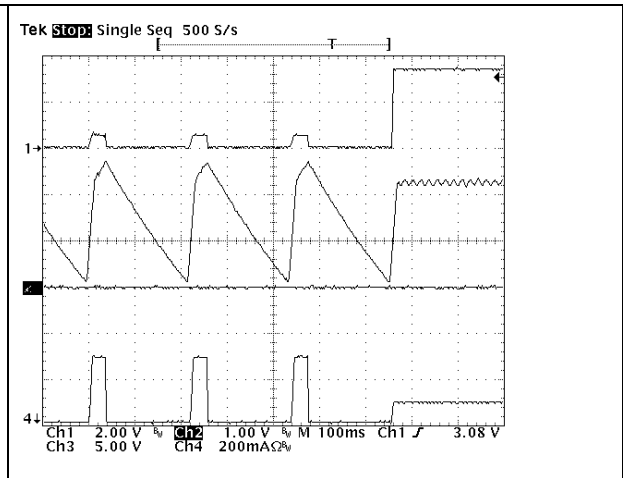
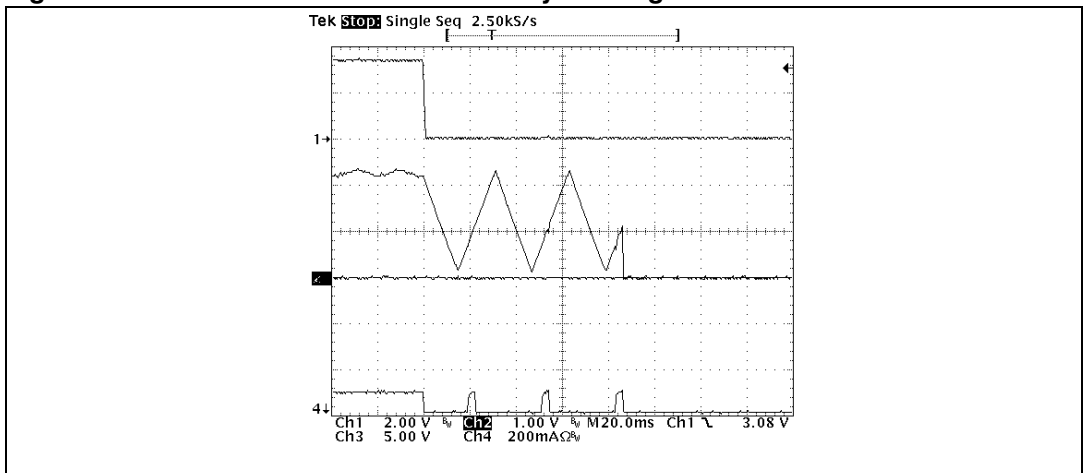

Figure 47. PM8800A recovering from a short on the load



Ch1 = output voltage, Ch2 = soft-start voltage, Ch3 = voltage across the hot-swap MOSFET, Ch4 = input current

Figure 48. Internal short on the secondary winding



Ch1 = output voltage, Ch2 = soft-start voltage, Ch3 = voltage across the hot-swap MOSFET, Ch4 = input current

Figure 49. Switch between 48 V PoE and 24 V AUXII with 3.3 V at 2 A

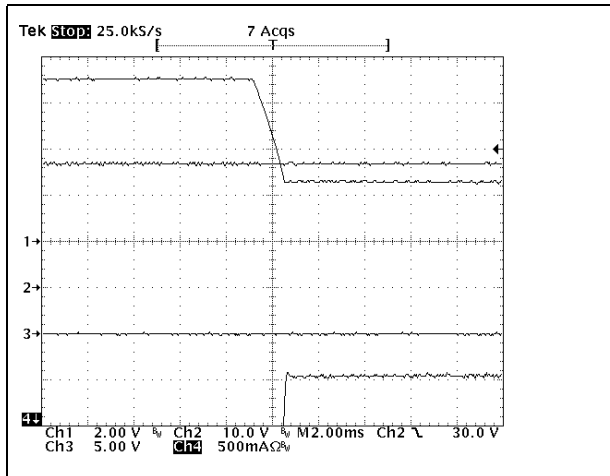
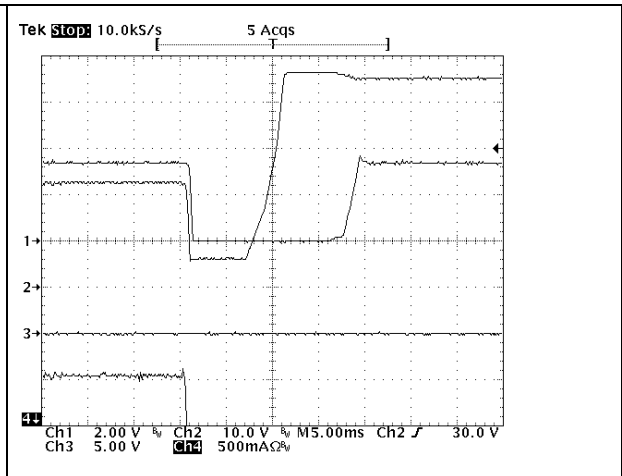

Figure 50. Back to 48 V removing the 24 V AUXII voltage with 3.3 V at 2 A



Ch1 = output voltage, Ch2 = internal primary voltage, Ch3 = voltage across the hot-swap MOSFET, Ch4 = AUXII input current

Figure 51. Switch between 48 V PoE and 12 V AUXII with 3.3 V at 2 A

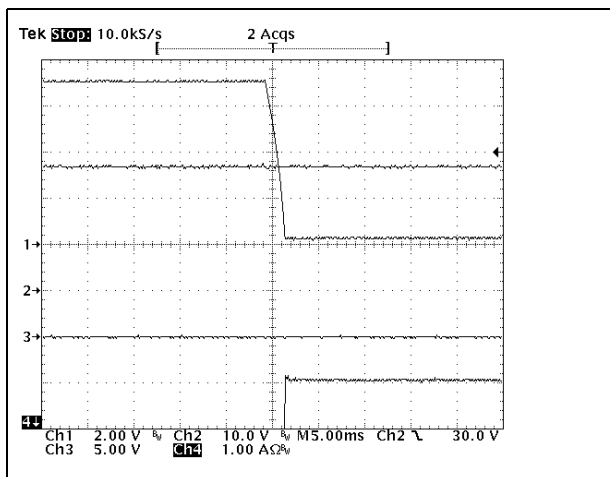
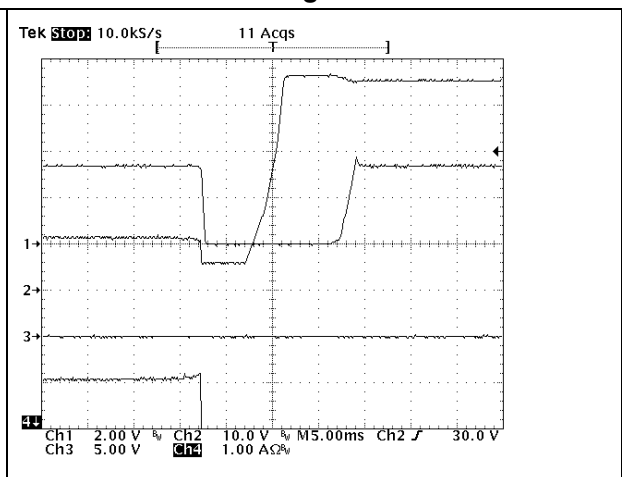

Figure 52. Back to 48 V removing the 12 V AUXII voltage with 3.3 V at 2 A



Ch1 = output voltage, Ch2 = internal primary voltage, Ch3 = voltage across the hot-swap MOSFET, Ch4 = AUXII input current

12.4 IEEE 802.3af compatibility test

Additional tests of compatibility to the IEEE802.3af standard have been done with the PDA100 PD tester from Sifos Technologies. Results obtained with the 5 V, 2 A standard board are summarized in [Table 5](#), [6](#), and [7](#). All tests have been successfully completed.

Table 5. Compatibility test at -45 degC

	Alt-A MDI	Alt-A MDI-X	Alt-B MDI	Alt-B MDI-X
Det. resistance	25.18 kΩ	25.16 kΩ	25.25 kΩ	25.25 kΩ
Det. capacitance	0.109 μF	0.092 μF	0.109 μF	0.103 μF
Class. current	1.4 mA	1.4 mA	1.4 mA	1.4 mA
Class result	0	0	0	0
Average power	12.52 W	12.52 W	12.38 W	12.38 W
Max current	266.2 mA	261.6 mA	258.8 mA	258.6 mA
Min current	260.3 mA	260.3 mA	257.4 mA	257.3 mA
Av. current	261.0 mA	260.9 mA	258.0 mA	258.0 mA
Turn-on voltage	40.0 V	40.0 V	40.0 V	40.0 V
Turn-off voltage	33.9 V	33.9 V	33.1 V	33.1 V

Table 6. Compatibility test at room temperature

	Alt-A MDI	Alt-A MDI-X	Alt-B MDI	Alt-B MDI-X
Det. resistance	24.90 kΩ	24.99 kΩ	24.95 kΩ	25.09 kΩ
Det. capacitance	0.103 μF	0.104 μF	0.104 μF	0.109 μF
Class. current	1.4 mA	1.3 mA	1.3 mA	1.3 mA
Class result	0	0	0	0
Average power	12.53 W	12.53 W	12.34 W	12.34 W
Max current	266.2 mA	262.0 mA	257.7 mA	257.6 mA
Min current	260.7 mA	260.5 mA	256.8 mA	256.8 mA
Average current	261.1 mA	261.2 mA	257.2 mA	257.1 mA
Turn-on voltage	40.0 V	40.0 V	40.0 V	40.0 V
Turn-off voltage	34.2 V	34.1 V	33.1 V	33.0 V

Table 7. Compatibility test at +85 degC

	Alt-A MDI	Alt-A MDI-X	Alt-B MDI	Alt-B MDI-X
Det. resistance	25.47 kΩ	25.49 kΩ	25.54 kΩ	25.57 kΩ
Det. capacitance	0.114 μF	0.112 μF	0.109 μF	0.103 μF
Class. current	1.3 mA	1.3 mA	1.3 mA	1.3 mA
Class result	0	0	0	0
Average power	12.59 W	12.59 W	12.36 W	12.37 W

Table 7. Compatibility test at +85 degC (continued)

	Alt-A MDI	Alt-A MDI-X	Alt-B MDI	Alt-B MDI-X
Max current	267.2 mA	263.0 mA	258.6 mA	258.6 mA
Min current	261.8 mA	261.8 mA	257.4 mA	257.2 mA
Average current	262.3 mA	262.4 mA	257.7 mA	257.8 mA
Turn-on voltage	39.8 V	39.7 V	39.7 V	39.7 V
Turn-off voltage	34.1 V	34.1 V	32.9 V	32.9 V

Appendix A Schematic of high-power board

Figure 53. Schematic of the 3.3/5 Vout high power with synchronous rectification

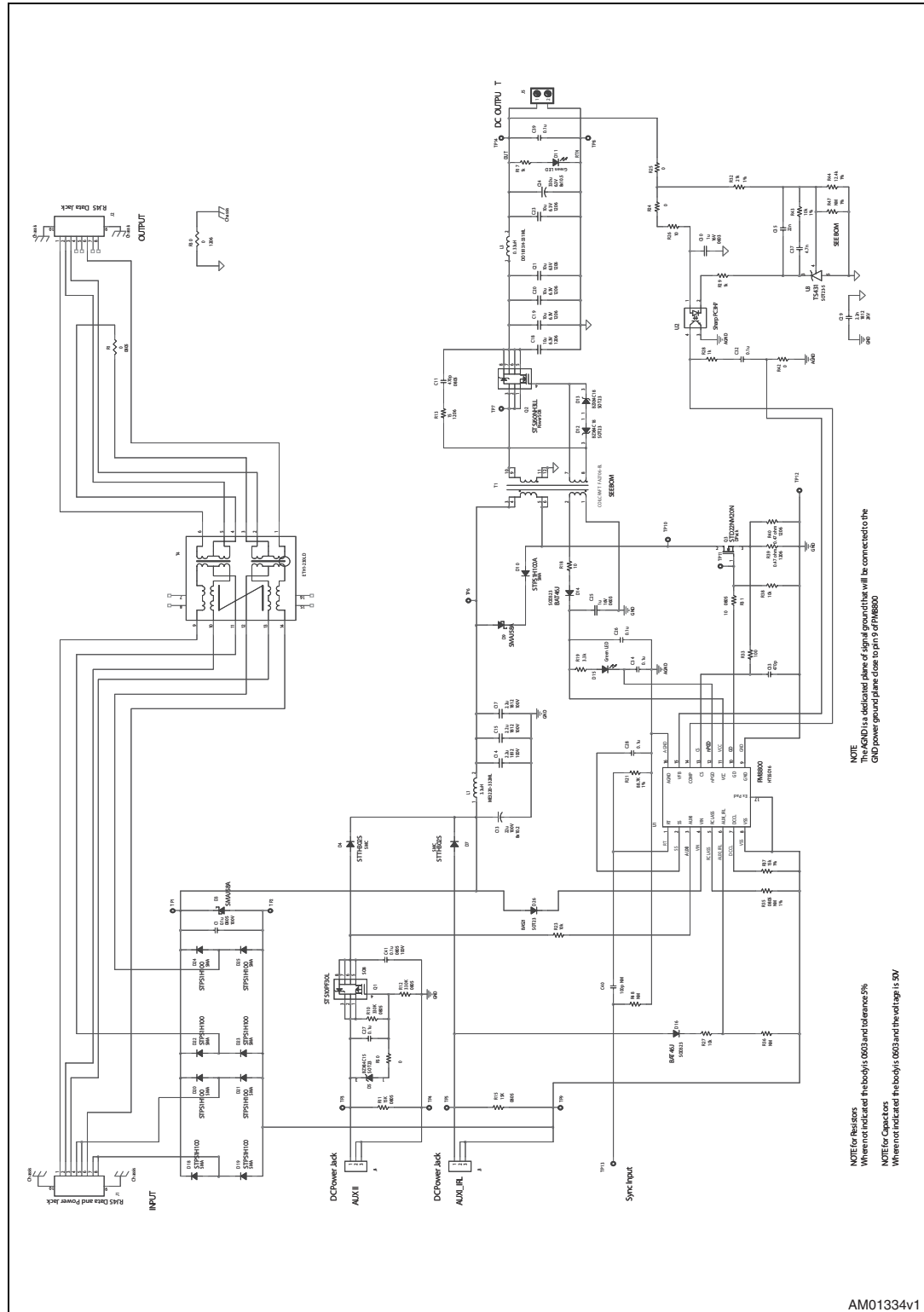

Appendix B Schematic of standard-power board

Figure 54. Schematic of the 3.3/5 Vout standard power with diode rectification

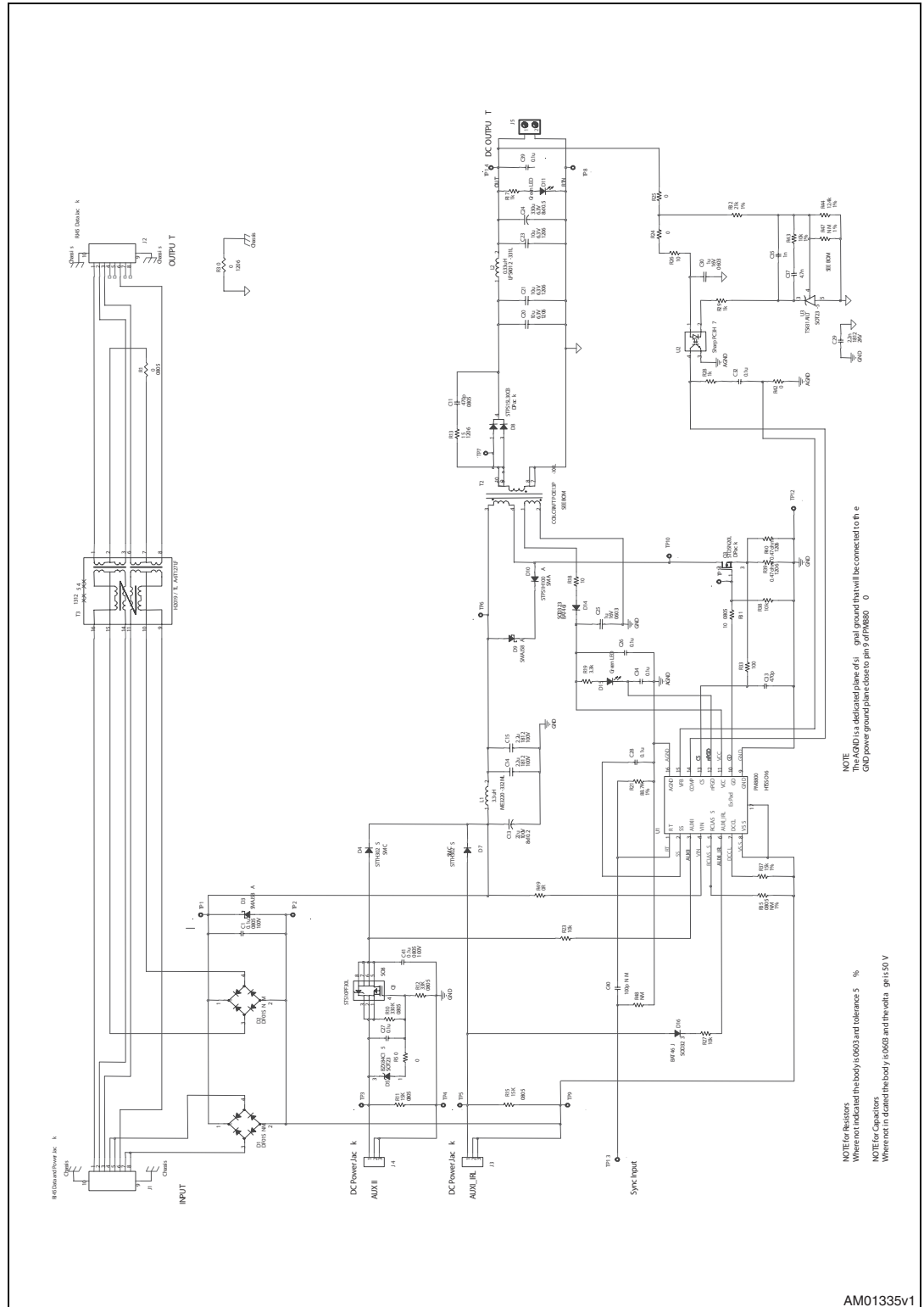

Revision history

Table 8. Document revision history

Date	Revision	Changes
13-Jul-2008	1	Initial release
04-Sep-2008	2	Modified: <i>Figure 2</i> and <i>53</i>

Please Read Carefully:

Information in this document is provided solely in connection with ST products. STMicroelectronics NV and its subsidiaries ("ST") reserve the right to make changes, corrections, modifications or improvements, to this document, and the products and services described herein at any time, without notice.

All ST products are sold pursuant to ST's terms and conditions of sale.

Purchasers are solely responsible for the choice, selection and use of the ST products and services described herein, and ST assumes no liability whatsoever relating to the choice, selection or use of the ST products and services described herein.

No license, express or implied, by estoppel or otherwise, to any intellectual property rights is granted under this document. If any part of this document refers to any third party products or services it shall not be deemed a license grant by ST for the use of such third party products or services, or any intellectual property contained therein or considered as a warranty covering the use in any manner whatsoever of such third party products or services or any intellectual property contained therein.

UNLESS OTHERWISE SET FORTH IN ST'S TERMS AND CONDITIONS OF SALE ST DISCLAIMS ANY EXPRESS OR IMPLIED WARRANTY WITH RESPECT TO THE USE AND/OR SALE OF ST PRODUCTS INCLUDING WITHOUT LIMITATION IMPLIED WARRANTIES OF MERCHANTABILITY, FITNESS FOR A PARTICULAR PURPOSE (AND THEIR EQUIVALENTS UNDER THE LAWS OF ANY JURISDICTION), OR INFRINGEMENT OF ANY PATENT, COPYRIGHT OR OTHER INTELLECTUAL PROPERTY RIGHT.

UNLESS EXPRESSLY APPROVED IN WRITING BY AN AUTHORIZED ST REPRESENTATIVE, ST PRODUCTS ARE NOT RECOMMENDED, AUTHORIZED OR WARRANTED FOR USE IN MILITARY, AIR CRAFT, SPACE, LIFE SAVING, OR LIFE SUSTAINING APPLICATIONS, NOR IN PRODUCTS OR SYSTEMS WHERE FAILURE OR MALFUNCTION MAY RESULT IN PERSONAL INJURY, DEATH, OR SEVERE PROPERTY OR ENVIRONMENTAL DAMAGE. ST PRODUCTS WHICH ARE NOT SPECIFIED AS "AUTOMOTIVE GRADE" MAY ONLY BE USED IN AUTOMOTIVE APPLICATIONS AT USER'S OWN RISK.

Resale of ST products with provisions different from the statements and/or technical features set forth in this document shall immediately void any warranty granted by ST for the ST product or service described herein and shall not create or extend in any manner whatsoever, any liability of ST.

ST and the ST logo are trademarks or registered trademarks of ST in various countries.

Information in this document supersedes and replaces all information previously supplied.

The ST logo is a registered trademark of STMicroelectronics. All other names are the property of their respective owners.

© 2008 STMicroelectronics - All rights reserved

STMicroelectronics group of companies

Australia - Belgium - Brazil - Canada - China - Czech Republic - Finland - France - Germany - Hong Kong - India - Israel - Italy - Japan - Malaysia - Malta - Morocco - Singapore - Spain - Sweden - Switzerland - United Kingdom - United States of America

www.st.com

