

BK PRECISION®

Model: 2840

[Click for Model: 2841](#)

2840 DC Resistance Meter

USER MANUAL



Safety Summary

The following safety precautions apply to both operating and maintenance personnel and must be followed during all phases of operation, service, and repair of this instrument.

WARNING

Before applying power to this instrument:

- Read and understand the safety and operational information in this manual.
- Apply all the listed safety precautions.
- Verify that the voltage selector at the line power cord input is set to the correct line voltage. Operating the instrument at an incorrect line voltage will void the warranty.
- Make all connections to the instrument before applying power.
- Do not operate the instrument in ways not specified by this manual or by B&K Precision.

Failure to comply with these precautions or with warnings elsewhere in this manual violates the safety standards of design, manufacture, and intended use of the instrument. B&K Precision assumes no liability for a customer's failure to comply with these requirements.

Category Rating

The IEC 61010 standard defines safety category ratings that specify the amount of electrical energy available and the voltage impulses that may occur on electrical conductors associated with these category ratings. The category rating is a Roman numeral of I, II, III, or IV. This rating is also accompanied by a maximum voltage of the circuit to be tested, which defines the voltage impulses expected and required insulation clearances. These categories are:

Category I (CAT I): Measurement instruments whose measurement inputs are not intended to be connected to the mains supply. The voltages in the environment are typically derived from a limited-energy transformer or a battery.

Category II (CAT II): Measurement instruments whose measurement inputs are meant to be connected to the mains supply at a standard wall outlet or similar sources. Example measurement environments are portable tools and household appliances.

Category III (CAT III): Measurement instruments whose measurement inputs are meant to be connected to the mains installation of a building. Examples are measurements inside a building's circuit breaker panel or the wiring of permanently-installed motors.

Category IV (CAT IV): Measurement instruments whose measurement inputs are meant to be connected to the primary power entering a building or other outdoor wiring.

WARNING

Do not use this instrument in an electrical environment with a higher category rating than what is specified in this manual for this instrument.

WARNING

You must ensure that each accessory you use with this instrument has a category rating equal to or higher than the instrument's category rating to maintain the instrument's category rating. Failure to do so will lower the category rating of the measuring system.

Electrical Power

This instrument is intended to be powered from a CATEGORY II mains power environment. The mains power should be 120 V RMS or 240 V RMS. Use only the power cord supplied with the instrument and ensure it is appropriate for your country of use.

Changing Line Voltage

WARNING

Disconnect all cables including the power cord from the instrument when changing the instrument's line voltage. After changing the line voltage setting, ensure the instrument has fuses of the proper ratings and types for the selected line voltage before applying line power.

Ground the Instrument

WARNING

To minimize shock hazard, the instrument chassis and cabinet must be connected to an electrical safety ground. This instrument is grounded through the ground conductor of the supplied, three-conductor AC line power cable. The power cable must be plugged into an approved three-conductor electrical outlet. The power jack and mating plug of the power cable meet IEC safety standards.

WARNING

Do not alter or defeat the ground connection. Without the safety ground connection, all accessible conductive parts (including control knobs) may provide an electric shock. Failure to use a properly-grounded approved outlet and the recommended three-conductor AC line power cable may result in injury or death.

WARNING

Unless otherwise stated, a ground connection on the instrument's front or rear panel is for a reference of potential only and is not to be used as a safety ground.

WARNING

Probes and Test Leads

- If the instrument is used with test leads or probes, the test leads or probes must have a safety category rating at least as high as that of the instrument to maintain the instrument's safety category rating.
- Use only probes that have finger-guards that prevent fingers from slipping down the probe body and contacting the probe's conductor.
- Inspect the probe or test leads for damage before using them. If you suspect a probe or test lead is damaged, remove it from service, mark it as unusable, and return to B&K Precision for maintenance service.
- Do not connect or disconnect test leads or probes from a circuit while that circuit is connected to a voltage source or may have non-discharged energy storage devices.
- Connect the probe or test leads to the measurement instrument before connecting them to the circuit to be tested. Disconnect the probe or test leads from the circuit to be tested before disconnecting them from the measurement instrument.
- For probes that have a voltage reference lead (for example, scope probes with a "ground lead"), connect the voltage reference lead only to conductors that are at ground potential.
- Do not use the probe or test leads in a condensing environment or where flammable materials (for example, dust, chemicals, or vapors) are present.
- Clean the probes or test leads only as instructed in their operating manuals.

Do not operate in an explosive or flammable atmosphere

WARNING

Do not operate the instrument in the presence of flammable gases or vapors, fumes, or finely-divided particulates.

WARNING

The instrument is designed to be used in office-type indoor environments. Do not operate the instrument

- In the presence of noxious, corrosive, or flammable fumes, gases, vapors, chemicals, or finely-divided particulates.
- In relative humidity conditions outside the instrument's specifications.
- In environments where there is a danger of any liquid being spilled on the instrument or where any liquid can condense on the instrument.
- In air temperatures exceeding the specified operating temperatures.
- In atmospheric pressures outside the specified altitude limits or where the surrounding gas is not air.
- In environments with restricted cooling air flow, even if the air temperatures are within specifications.
- In direct sunlight.

CAUTION

This instrument is intended to be used in an indoor pollution degree 2 environment. The operating temperature range is 0 °C to 40 °C and the operating humidity is ≤ 80 % relative humidity, with no condensation allowed.

Measurements made by this instrument may be outside specifications if the instrument is used in non-office-type environments. Such environments may include rapid temperature or humidity changes, sunlight, vibration and/or mechanical shocks, acoustic noise, electrical noise, strong electric fields, or strong magnetic fields.

Do not operate instrument if damaged

WARNING

If the instrument is damaged, appears to be damaged, or if any liquid, chemical, or other material gets on or inside the instrument, remove the instrument's power cord, remove the instrument from service, label it as not to be operated, and return the instrument to B&K Precision for repair. Notify B&K Precision of the nature of any contamination of the instrument.

Clean the instrument only as instructed

WARNING

Do not clean the instrument, its switches, or its terminals with contact cleaners, abrasives, lubricants, solvents, acids/bases, or other such chemicals. Clean the instrument only with a clean dry lint-free cloth or as instructed in this manual.

Not for critical applications

⚠ WARNING

This instrument is not authorized for use in contact with the human body or for use as a component in a life-support device or system.

Do not touch live circuits

⚠ WARNING

Instrument covers must not be removed by operating personnel. Component replacement and internal adjustments must be made by qualified service-trained maintenance personnel who are aware of the hazards involved when the instrument's covers and shields are removed. Under certain conditions, even with the power cord removed, dangerous voltages may exist when the covers are removed. To avoid injuries, always disconnect the power cord from the instrument, disconnect all other connections (for example, test leads, computer interface cables, etc.), discharge all circuits, and verify there are no hazardous voltages present on any conductors by measurements with a properly-operating voltage-sensing device before touching any internal parts. Verify the voltage-sensing device is working properly before and after making the measurements by testing with known-operating voltage sources and test for both DC and AC voltages. Do not attempt any service or adjustment unless another person capable of rendering first aid and resuscitation is present.

Do not insert any object into an instrument's ventilation openings or other openings.

WARNING

Hazardous voltages may be present in unexpected locations in circuitry being tested when a fault condition in the circuit exists.

Fuse Replacement

WARNING

Fuse replacement must be done by qualified service-trained maintenance personnel who are aware of the instrument's fuse requirements and safe replacement procedures. Disconnect the instrument from the power line before replacing fuses. Replace fuses only with new fuses of the fuse types, voltage ratings, and current ratings specified in this manual or on the back of the instrument. Failure to do so may damage the instrument, lead to a safety hazard, or cause a fire. Failure to use the specified fuses will void the warranty.

Servicing

CAUTION

Do not substitute parts that are not approved by B&K Precision or modify this instrument. Return the instrument to B&K Precision for service and repair to ensure that safety and performance features are maintained.

ESD Sensitivity

CAUTION

This product uses components which can be damaged by electrostatic discharge (ESD). To avoid damage, follow proper procedures for handling, storing and transporting parts and subassemblies which contain ESD-sensitive components.

Cooling Fans

CAUTION

This instrument contains one or more cooling fans. For continued safe operation of the instrument, the air inlet and exhaust openings for these fans must not be blocked nor must accumulated dust or other debris be allowed to reduce air flow. Maintain at least 25 mm clearance around the sides of the instrument that contain air inlet and exhaust ports. If mounted in a rack, position power devices in the rack above the instrument to minimize instrument heating while rack mounted. Do not continue to operate the instrument if you cannot verify the fan is operating (note some fans may have intermittent duty cycles). Do not insert any object into the fan's inlet or outlet.

For continued safe use of the instrument

- Do not place heavy objects on the instrument.
- Do not obstruct cooling air flow to the instrument.
- Do not place a hot soldering iron on the instrument.
- Do not pull the instrument with the power cord, connected probe, or connected test lead.
- Do not move the instrument when a probe is connected to a circuit being tested.

Compliance Statements

Disposal of Old Electrical & Electronic Equipment (Applicable in the European

Union and other European countries with separate collection systems)

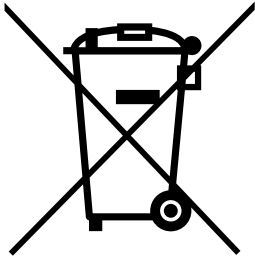

This product is subject to Directive 2002/96/EC of the European Parliament and the Council of the European Union on waste electrical and electronic equipment (WEEE), and in jurisdictions adopting that Directive, is marked as being put on the market after August 13, 2005, and should not be disposed of as unsorted municipal waste. Please utilize your local WEEE collection facilities in the disposition of this product and otherwise observe all applicable requirements.

CE Declaration of Conformity

This instrument meets the requirements of the Low Voltage Directive, 2006/95/EC and Electromagnetic Compatibility Directive, 2004/108/EC using the standards referenced below:









Low Voltage

- EN 61010-1:2010
- EN 61010-2-030:2010

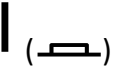
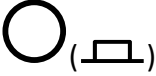
EMC Directive

- EN 61326-1:2013
- EN 61000-3-2:2006+A1:2009+A2:2009
- EN 61000-3-3:2008

Safety Symbols

	Refer to the user manual for warning information to avoid hazard or personal injury and prevent damage to instrument.
	Electric Shock hazard
	On (Supply). This is the AC mains connect/disconnect switch on the front of the instrument.
	Off (Supply). This is the AC mains connect/disconnect switch on the front of the instrument.
	Protective earth ground
	CAUTION indicates a hazardous situation which, if not avoided, will result in minor or moderate injury
	WARNING indicates a hazardous situation which, if not avoided, could result in death or serious injury
	DANGER indicates a hazardous situation which, if not avoided, will result in death or serious injury.
	NOTICE is used to address practices not related to physical injury.

Notations

TEXT – Denotes a softkey.

TEXT – Denotes a front panel button.

Table of Contents

1.1	Product Overview	16
1.2	Package Contents	16
1.3	Dimensions	17
1.4	Front Panel Overview	18
1.5	Rear Panel Overview.....	19
1.6	Keypad Overview	20
1.7	Display Overview	21
2.1	Input Power Requirements	22
2.2	Fuse Requirements	22
2.3	Input Connections	25
2.4	Preliminary Check	25
2.5	Cable Calibration	26
3.1	Measurement Display.....	29
3.1.1	OPTIONS	30
3.1.2	FUNC.....	31
3.1.3	RANGE	31
3.1.4	SPEED.....	31
3.1.5	TRIG	32
3.2	Comparator Display	32
3.2.1	OPTIONS	33
3.2.2	COMP.....	33
3.2.3	COMP MODE	33
3.3	Bin Display	34
3.3.1	OPTIONS	35
3.3.2	BIN	35

3.3.3	BIN BEEP	35
3.3.4	NG COLOR & GD COLOR	36
3.4	Statistics DisplayT	37
3.4.1	OPTIONS	37
3.4.2	Edge Mode	38
3.4.3	Status.....	38
	Statistical Analysis Parameters.....	38
3.4.4	38
4.1	Measurement Setup	40
4.1.1	FUNC.....	41
4.1.2	RANGE	41
4.1.3	TRIG	41
4.1.4	TRIG DELAY	41
4.1.5	AVERAGE	42
4.1.6	SPEED.....	42
4.1.7	0 ADJ.....	42
4.2	Bin Setup.....	42
4.2.1	OPTIONS	43
4.2.2	BIN 1 to 3.....	43
4.2.3	STATE.....	43
4.2.4	BIN MODE.....	43
4.3	System Setup	44
4.3.1	OPTIONS	45
4.3.2	Touch Tone.....	45
4.3.3	Language	46
4.3.4	Password	46
4.3.5	Bus Mode	46
4.3.6	Baud Rate	46
4.3.7	AC Frequency	47
4.3.8	Handler VCC	47
4.3.9	Setting Time and Date.....	47
5.1	File Structure	48
5.1.1	Saving Configuration Files	48
5.1.2	Load Configuration Files.....	49
5.1.3	Delete File.....	49
5.1.4	Copy File to I:/E:	49

5.1.5	Select	49
5.2	SCREEN COPY	50
5.3	SAVE DATA.....	50
5.4	USB Flash Driver Requirements.....	50
6.1	Timing	52
7.1	RS232C.....	54
7.2	USBTMC	55
7.3	USB (USBCDC - Virtual COM).....	55
7.4	Remote Commands	55
8.1	Handler Sequence.....	57
8.2	Isolated Output.....	58

1 General Information

1.1 Product Overview

The BK Precision's 2840 DC Resistance Meter can handle a broad range of resistances measurements. Its maximum accuracy of 0.1% and its range, 1 mΩ to 20 kΩ are vividly displayed on the color LCD touchscreen in 4½ digits. The 2840 is ideal for testing resistances found in PCBs, conductors, relay contacts, interconnections, welding-holes as well as resistors and bigger components. The statistical analysis function provides the average, maximum, minimum, population standard deviation and sample standard deviation of the measured datasets. The statistical analysis can also provide the Process Capability Index (Cp, Cpk) which indicates the ability of a process to produce an output within the user's specification limits.

Features:

- Measurement Range: 1 mΩ to 20 kΩ
- Minimum resolution: 1 μΩ
- Maximum accuracy: 0.1%
- Lower power measurement function: LPR
- Bin sorting comparator with up to 3 bins
- Process Capability Index (Cp)
- Standard USB and RS232C interface
- Intelligent detection for test state error
- Handler interface for on-line operation.
- 4.3" LCD touchscreen, 480×272 resolution

1.2 Package Contents

Please inspect the instrument mechanically and electrically upon receiving it. Unpack all items from the shipping carton, and check for any obvious signs of physical damage that may have occurred during transportation. Report any damage to the shipping agent immediately. Save the original packing carton for possible future reshipment. Every instrument is shipped with the following contents:

1 x 2840 DC resistance meter

1 x 4-terminal Kelvin test clips

1 x AC power cord

1 x Certificate of Calibration

1 x Test Report

Verify that all items above are included in the shipping container. If anything is missing, please contact B&K Precision.

Note: User manual is available for download at www.bkprecision.com

1.3 Dimensions

The 2840 dimensions are approximately: 255 mm x 110 mm x 361 mm (10.04 in x 4.33 in x 14.22 in) (W x H x D).

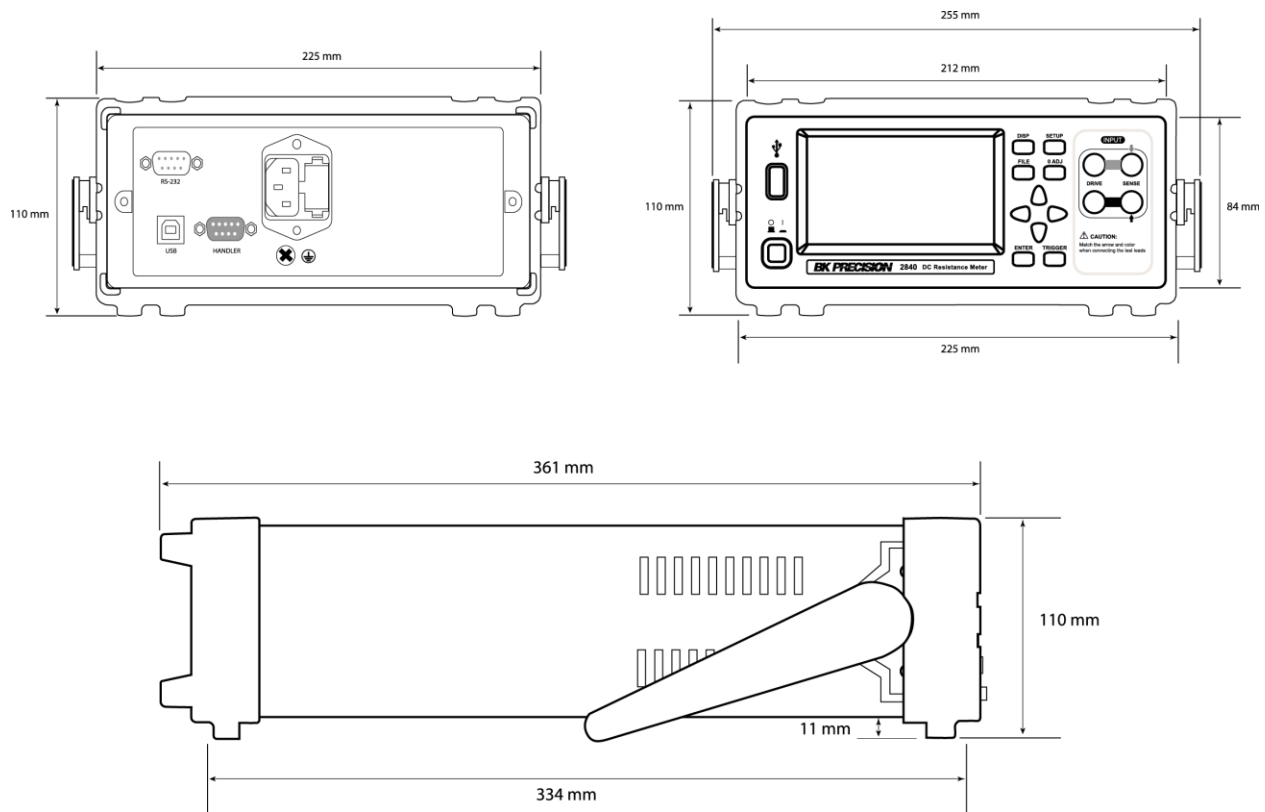

Figure 1 - Dimensions

1.4 Front Panel Overview

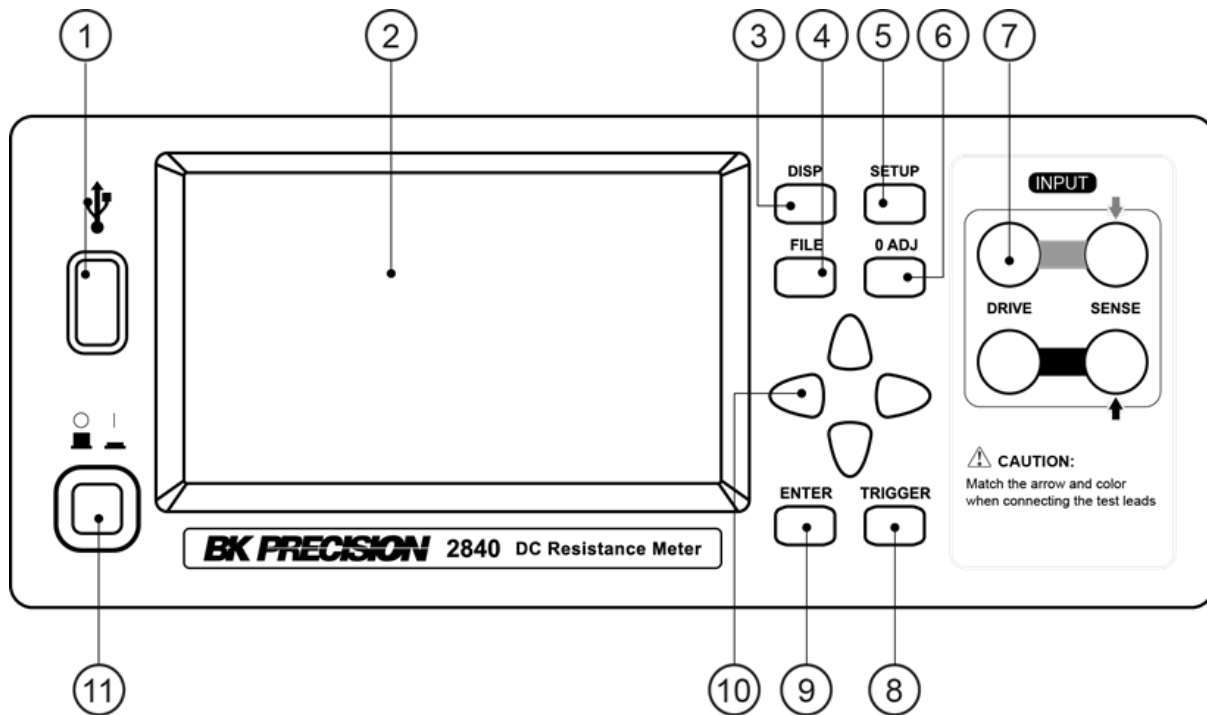

Figure 2 - Front Panel

①	USB Interface
②	LCD Touchscreen
③	DISP
④	FILE
⑤	SETUP
⑥	0 ADJ
⑦	Test Terminals
⑧	TRIGGER
⑨	ENTER
⑩	Universal Arrow Keys
⑪	Power

1.5 Rear Panel Overview

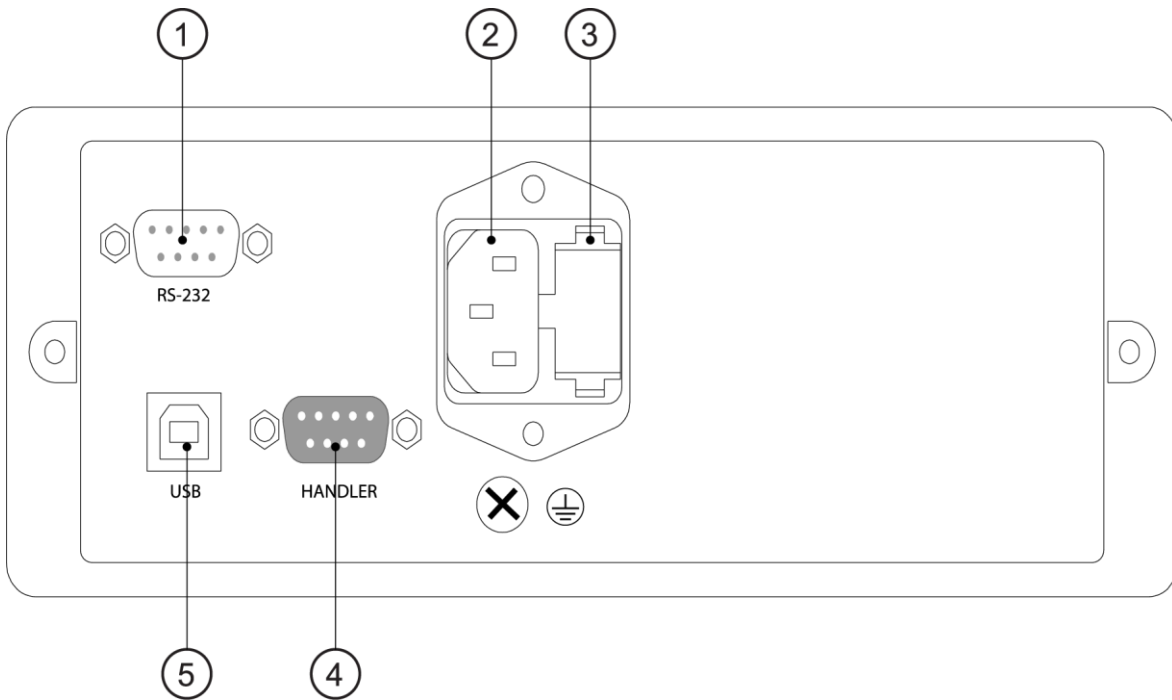

Figure 3 - Rear Panel

Rear Panel Description

①	RS-232 Serial Interface
②	Power Socket
③	Fuse Socket
④	Handler Interface
⑤	USB Interface

1.6 Keypad Overview

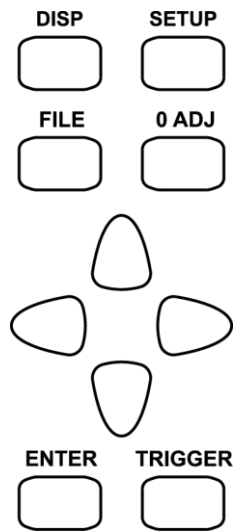





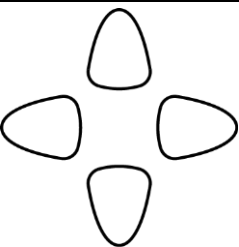

Figure 4 - Keypad

Keypad Description

<p>DISP</p> 	<p>DISP key Enters the main measurement display and opens display options</p>
<p>SETUP</p> 	<p>SETUP key Enters the setup menu.</p>
<p>FILE</p> 	<p>FILE key Enters the internal and external file manager</p>
<p>0 ADJ</p> 	<p>0 ADJ key Executes zero adjustment function</p>
<p>TRIGGER</p> 	<p>TRIGGER key Manual trigger when trigger mode is set to MANU (manual)</p>
<p>ENTER</p> 	<p>ENTER key Confirms setting</p>
	<p>Universal Arrow Keys Used to navigate any menu</p>

1.7 Display Overview

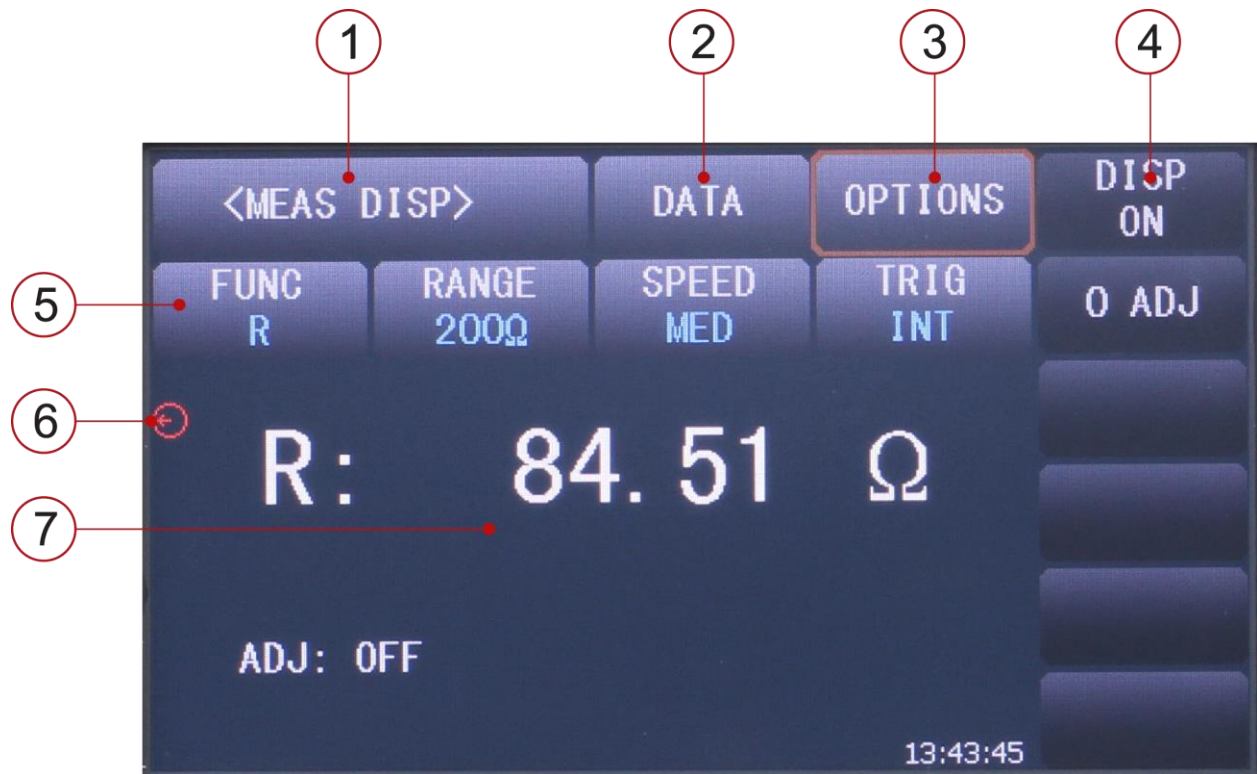

Figure 5 - Display

Display Description

- | | |
|---|---|
| ① | Display Name - Shows the current display name |
| ② | DATA – Access to save screen and file management (internal or external) |
| ③ | OPTIONS – Access to additional display specific functions |
| ④ | MENU OPTIONS – Displays the function menu depending on cursor location |
| ⑤ | FUNCTION –Access to measurement options |
| ⑥ | MEASUREMENT INDICATOR – Arrow rotates when a measurement is performed |
| ⑦ | RESULTS DISPLAY – Shows values of ongoing measurement |

2 Getting Started

Before connecting and powering up the instrument, please review and go through the instructions in this chapter.

2.1 Input Power Requirements

The supply has a universal AC input that accepts line voltage input within:

Voltage: 110 V to 240 V ($\pm 10\%$)

Frequency: 50 Hz to 60 Hz ($\pm 5\%$)

Power supply power range: $\leq 30VA$

The instrument has 50 and 60 Hz user selectable line filter in . Select 50 Hz or 60 Hz to match the line frequency. If the input power line has excessive noise, additional external noise filtering may be required.

Before connecting to an AC outlet or external power source, make sure that the power switch is in the OFF position and verify that the AC power cord, including the extension line, is compatible with the rated voltage/current and that there is sufficient circuit capacity for the power supply. Once verified, connect the cable firmly.

⚠ WARNING

The included AC power cord is safety certified for this instrument operating in rated range. To change a cable or add an extension cable, be sure that it can meet the required power ratings for this instrument. Any misuse with wrong or unsafe cables will void the warranty.

2.2 Fuse Requirements

An AC input fuse is necessary when powering the instrument. The fuse is located at the back of the instrument. In the event the fuse needs to be replaced, make sure the AC input power cord is disconnected from the instrument before replacing. The below table shows the fuse required for all specified AC input voltages.

⚠ WARNING

Before replacing fuse, disconnect AC input power cord first to prevent electric shock. Only use a fuse of the same rating as required. Using a different rated fuse will damage the instrument.

Rating	Fuse Specification
~110V/60Hz	T2AL 250V
~220V/50Hz	T1AL 250V

Table 1 - Fuse Specification

Follow the steps below to check or change fuse and line voltage selection.

Step 1 - Check and/or Change Fuse

- Locate the fuse box above the AC input in the rear panel.
- With 2 fingers, press both left and right sides of the fuse box and pull it out.
- Check and replace fuse (if necessary) for the desired line voltage operation.

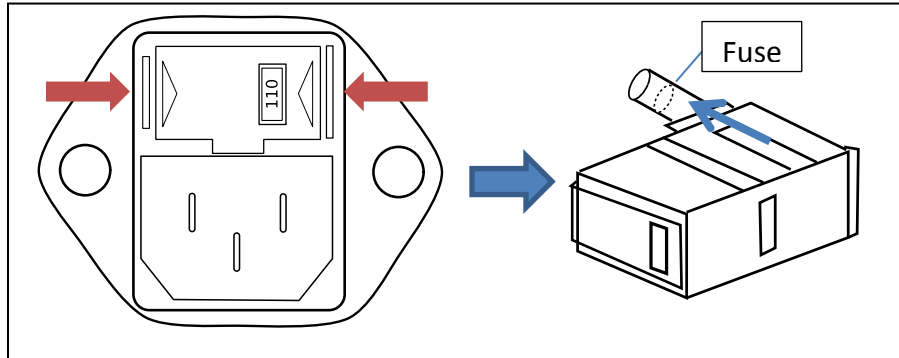

Figure 6 - Remove Fuse Casing

Step 2 - Check and/or Change Line Voltage

- The line voltage selector is the fuse holder that contains the fuse. Follow the step above to remove the fuse box.
- The grey colored piece is the fuse holder and the line voltage selector. To change the line voltage configuration between **110 V** and **220 V**, pull this piece out of the fuse box and rotate it 180 degrees.
- Place it back in the fuse box. The front of the fuse box has an opening, which should indicate the line voltage you configured. It should display either **110** or **220**. If neither of these labels is shown in the fuse box opening, pull out the fuse holder and turn it again until it shows the line voltage configuration desired.

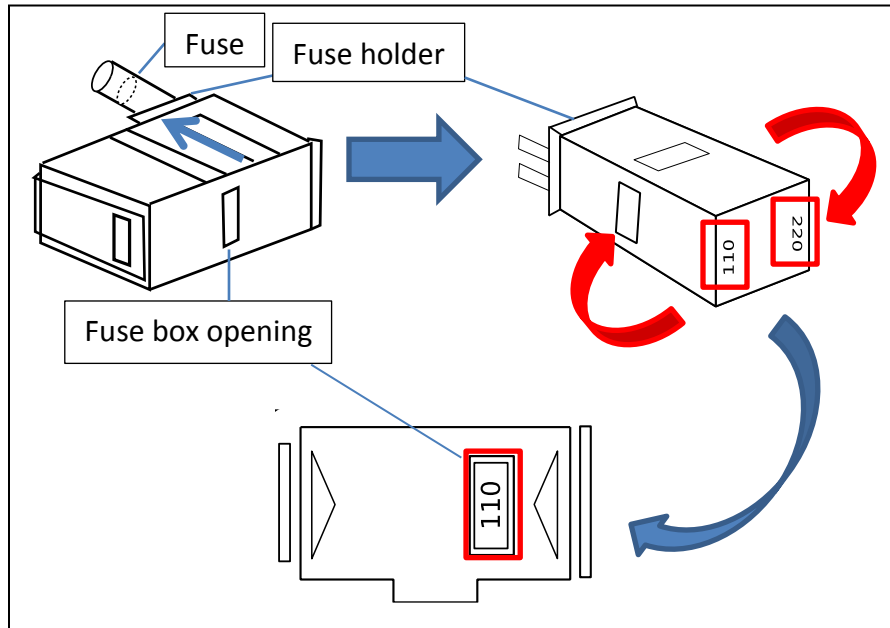

Figure 7 - Rotate to line voltage



Any disassembling of the case or changing the fuse not performed by an authorized service technician will void the warranty of the instrument.

2.3 Input Connections

The instrument uses 4-terminal Kelvin test clips to measure more accurately and attain a higher level of performance than 2-terminal clips. Connect the cable to HI and LO terminals on the instrument front panel. Check the color and alignment arrows conformity of the test fixture with that of the connectors (see **Figure 8**). Do not insert the connectors vertically as this will cause inaccurate measurements (see **Figure 9**).

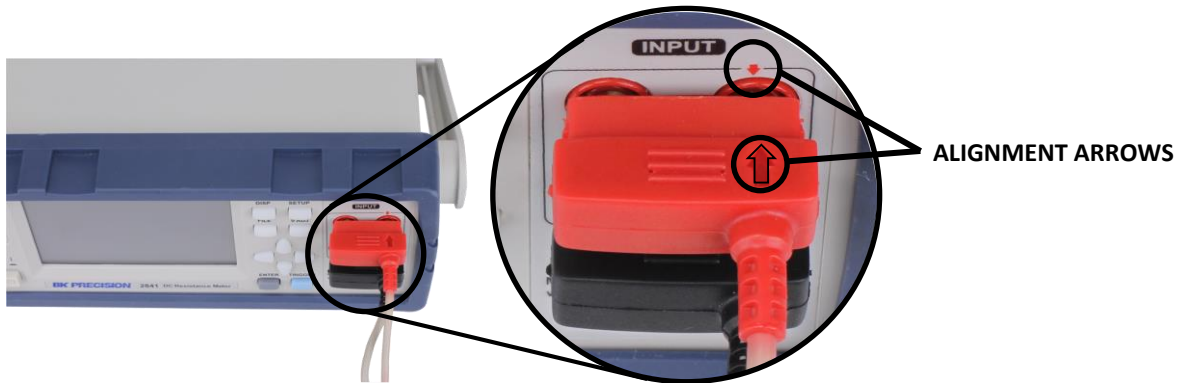

Figure 8 - Connection Alignment



Figure 9 - Do Not Connect Vertically

2.4 Preliminary Check

Complete the following steps to verify that the instrument is ready for use.

1. Verify AC Input Voltage

Verify and check to make sure proper AC voltages are available to power the instrument. The AC voltage range must meet the acceptable specification as explained in Input Power Requirements.

2. Connect Power

Connect AC power cord to the AC receptacle in the rear panel and press the power switch to the I () ON position to turn ON the instrument. The instrument will have a boot screen while loading (see **Figure 10**), after which the main screen will be displayed.

After power on, the loading screen will be displayed for about five seconds. The firmware version is found on the loading screen:



Figure 10 - Boot Screen

If password protection is enabled, the user will have to input the password to operate the unit. The default password is 2840. See 4.3.4 Password for more details.

2.5 Cable Calibration

The resistance in the 4-terminal cables can be compensated for through the zero adjustment (0 ADJ) function. This should be performed when connecting a new cable to the instrument, when the environment temperature changes ± 5 °C, or when desired.

Complete the following steps to perform the cable calibration:

1. Warm-up the instrument for 30 minutes.
2. Short the 4-terminal connectors together (see Figure 11).
3. Ensure **DRIVE+** is aligned with **DRIVE-** and **SENSE+** is aligned with **SENSE-**.
4. Select a resistance range or AUTO to calibrate for all ranges.
5. Initiate the calibration function. Press 0 ADJ on the front panel.
6. Calibration time is affected by the SPEED, AVERAGE samples, and auto ranging.

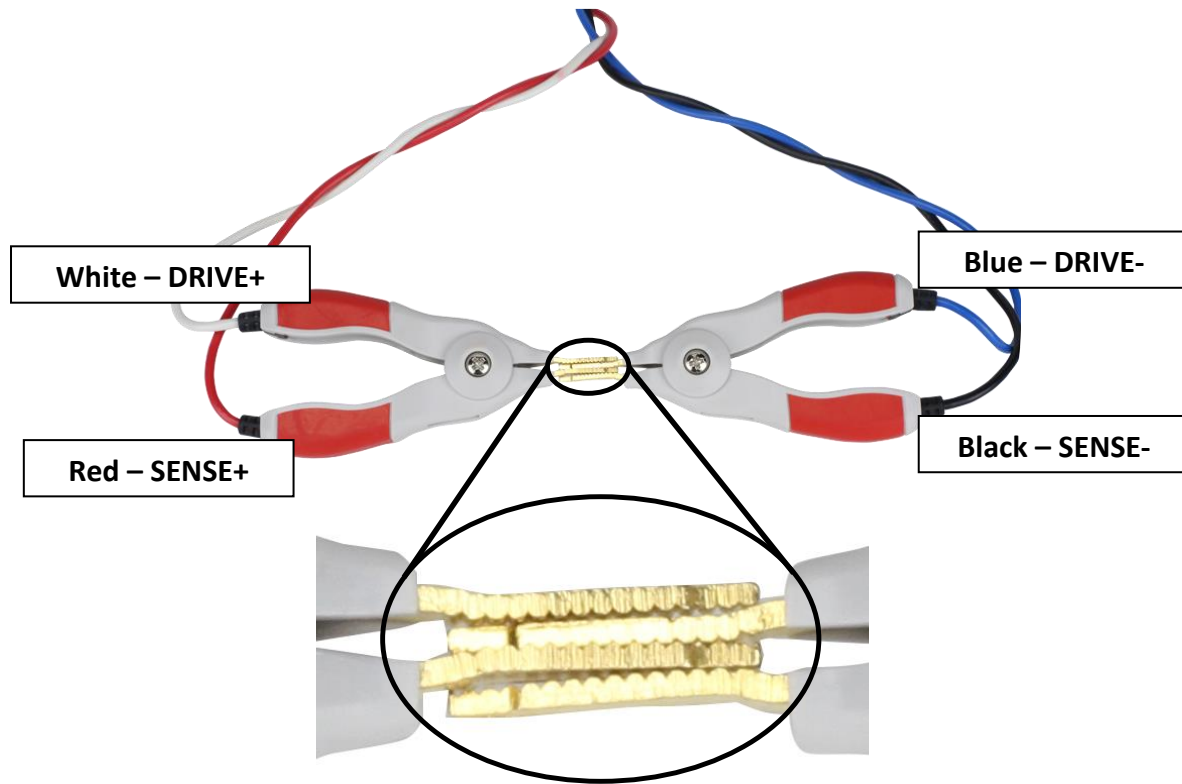

Figure 11 - Short Connection

3 Front Panel Operation

The touchscreen menu displays contains all measurement and function options. The universal arrow keys along with the **ENTER** key can also be used to navigate the touchscreen. The measurement display menu consists of a primary menu and a secondary menu shown to the right of the screen.

There are 4 measurement operation displays:

1. Measurement Display
2. Comparator Display
3. Bin Display
4. Statistics Display

Each display and setup page has a **DATA** option for quick access to the file manager, screen copy, and save data functions. See **FILE MANAGER** for details.

When prompted to enter a numeric value, the numeric keypad will be displayed. Press **Enter** to confirm the value or **u**, **m**, **k** or **M** to confirm the value with the corresponding magnitude.

u = 10^{-6} ; **m** = 10^{-3} ; **k** = 10^3 ; **M** = 10^6

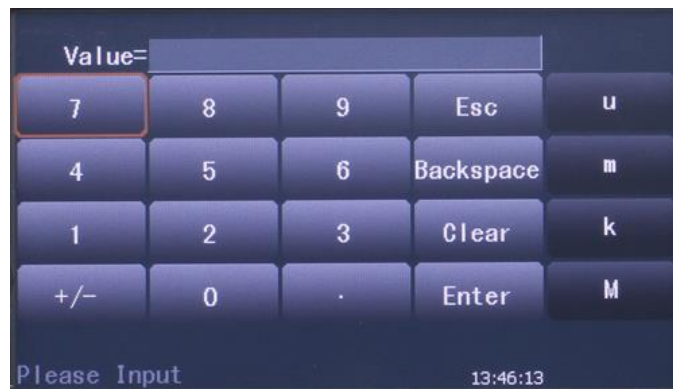

Figure 12 - Numeric Keypad

When prompted to enter an alphanumeric value, the alphanumeric keypad will be displayed.



Figure 13 - Alphanumeric Keypad

3.1 Measurement Display

The Measurement Display (MEAS DISP) is the main page for displaying resistance measurements. To access the page press the **DISP** button and select **MEAS DISP** in menu options. See 1.1 for additional options.

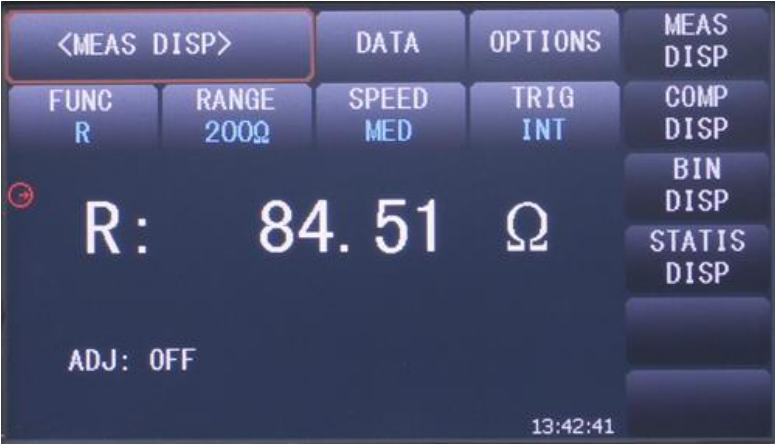

Figure 14 - Measurement Display

Touch the measurement result area to zoom the display, removing the menu options from the display. Touch again to return to the normal screen display.



Figure 15 - Zoom Display

The following parameters are accessible from the Measurement Display:

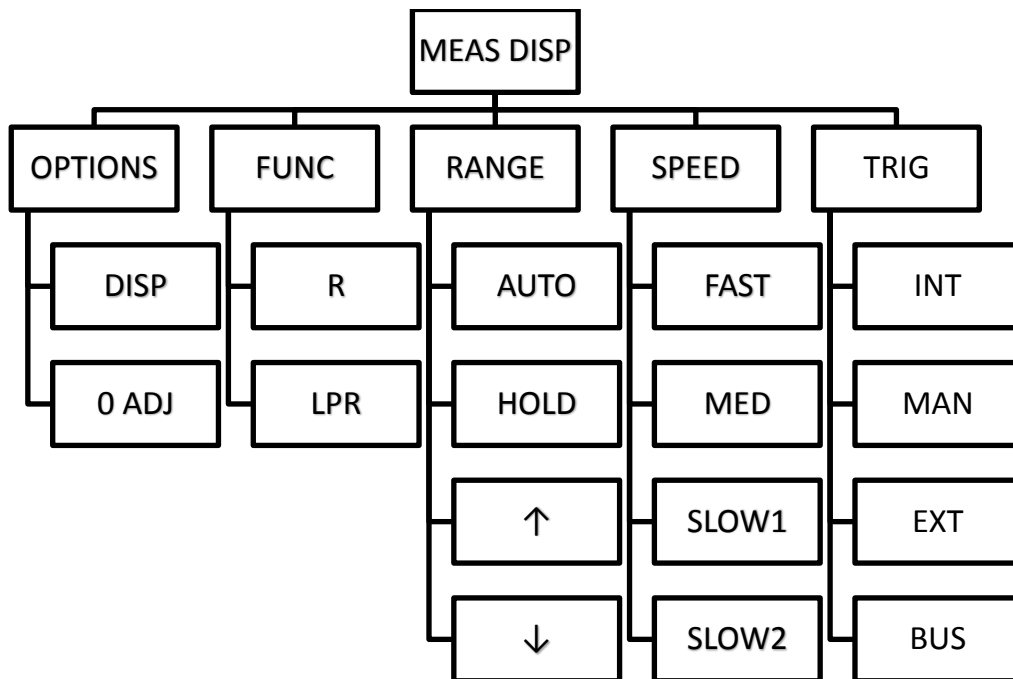

Figure 16 - MEAS DISP Menu Tree

3.1.1 OPTIONS

The **OPTIONS** key allows the user to access the additional measurement options menu.

The measurement options are:

- **DISP (ON/OFF)**: Toggle the measurement results display on and off.
- **0 ADJ**: Execute zero adjustment. See 2.5 Cable Calibration for details.

3.1.2 FUNC

The **FUNC** key allows the user to measure resistance in normal or low voltage modes.

The measurement modes are:

- **R:** Resistance
- **LPR:** Resistance tested at low voltage

3.1.3 RANGE

There are 2 resistance measurement modes:

1. Measurement Mode (R) with 7 ranges:
2. 20 mΩ, 200 mΩ, 2 Ω, 20 Ω, 200 Ω, 2 kΩ, 20 kΩ
3. Measurement Mode at Low Voltage (LPR) with 4 ranges:
4. 2 Ω, 20 Ω, 200 Ω, 2 kΩ

Follow the instructions below to set the resistance measurement ranges.

1. Touch the **RANGE** key, the following menu options will be displayed:
 - **AUTO:** Automatically selects the range mode depending on the resistance detected.
 - **HOLD:** Lock to the current resistance measurement range.
 - **↑ (+):** Increase measurement range and sets the measurement to **HOLD**.
 - **↓ (-):** Decrease measurement range and sets the measurement to **HOLD**.

3.1.4 SPEED

The **SPEED** key controls the measurement time. In **SLOW1** and **SLOW2** mode noise is lower but measurement time is increased. **FAST** mode performs high speed measurements but with increased noise. See **1.1** for timing details.

Follow the instructions below to set the measurement speed.

1. Touch the **SPEED** key, the following menu options will be displayed:
 - **FAST**
 - **MED**
 - **SLOW1**
 - **SLOW2**

Note: In SLOW2, SLOW1 or MED mode the display measurement is 5 digits. FAST mode is 4 digits.

3.1.5 TRIG

The **TRIG** key is used to select the trigger options. See 4.1.3 for more details.

3.2 Comparator Display

The Comparator Display (COMP DISP) page compares the resistance measurement to absolute limits or a nominal value \pm a percentage. The total count (TOT) is incremented and the result is categorized as high (HI), low (LO), or in (IN). To access the page press the **DISP** button and select **COMP DISP** in menu options.

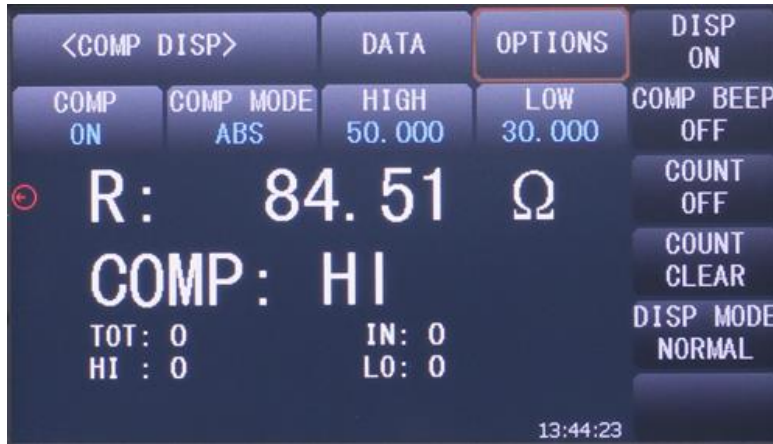

Figure 17 - Comparator NORMAL Display

When in **DEV** display mode, the following screen will be displayed.



Figure 18 - Comparator DEV Display

The following parameters are accessible from the Comparator Display:

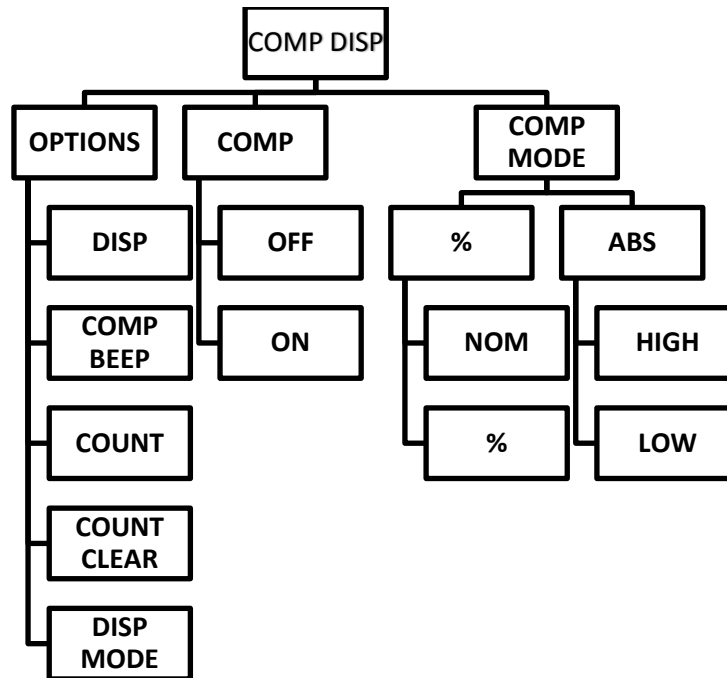

Figure 19 - COMP DISP Menu Tree

3.2.1 OPTIONS

The **OPTIONS** key allows the user to access the additional comparator option menu.

The options are:

- **DISP (ON/OFF)**: Toggle the measurement results display on and off
- **COMP BEEP (OFF/NG/GD)**: Toggles beep between off, not good (NG) and good (GD).
- **COUNT (ON/OFF)**: ON begins the comparator count if **COMP** is **ON**. Count increments based on trigger settings. OFF stops the count.
- **COUNT CLEAR**: HI, LO, IN, and TOT counts are reset to 0.
- **DISP MODE**: Toggle between **NORMAL** and **DEV** modes. **NORMAL** shows the resistance measurement. **DEV** shows a percentage (Δ) based on the following equation:

$$\Delta = (\text{Measured Resistance} - \text{Nominal Value}) / \text{Nominal Value} \times 100\%$$

3.2.2 COMP

The **COMP** key turns the comparator functions **ON** and **OFF**. Results are in the results display area. COMP: NC will be displayed if **COMP** is **OFF**.

3.2.3 COMP MODE

The **COMP MODE** key allows the user to access two comparator modes.

- **% (Percent Error)**: The user can set the nominal value (**NOM**) and the percent error (**%**). If the nominal value is 100 and percentage is 10, the tolerance will be 100±10%. The

instrument will compare the measured value to the tolerance and determine if the DUT is HI (above tolerance), LO (below tolerance), or IN (within tolerance). The display will show \pm percent (Δ) difference the measurement is from the nominal value.

- **ABS (Absolute):** The user can set absolute **HIGH** and **LOW** limits. The instrument will compare the measured value to the absolute limits and determine if the DUT is HI (above the upper limit), LO (below the lower limit), or IN (within limits).

3.3 Bin Display

The Bin Display (BIN DISP) page places the resistance measurement in up to 3 user defined bins. See **0** for instructions to define the bins. The bin operation is executed when the instrument is triggered. To access the page press the **DISP** button and select **BIN DISP** in menu options.



Figure 20 - Bin Display

When the measurement is outside of a bin's tolerance, it is defined as **NOT GOOD (NG)**. When the measurement is inside of a bin's tolerances, it is defined as **GOOD (GD)**.

The following parameters are accessible from the Bin Display:

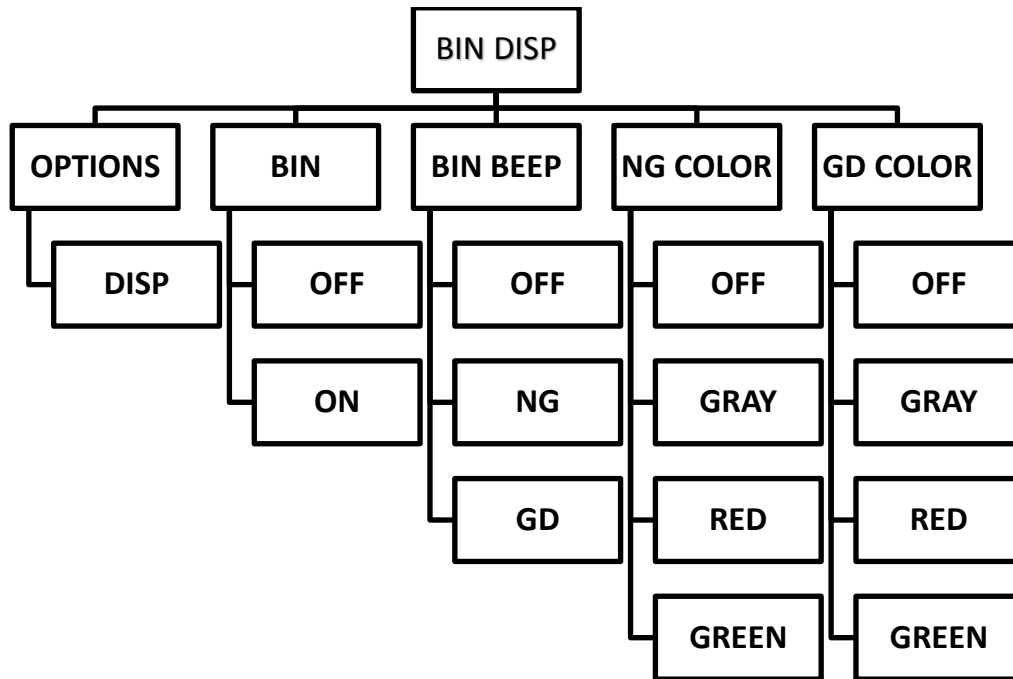

Figure 21 - BIN DISP Menu Tree

3.3.1 OPTIONS

The **OPTIONS** key allows the user to access the additional bin options menu.

The options are:

- **DISP (ON/OFF)**: Toggle the resistance measurement results display on and off

3.3.2 BIN

The **BIN** key turns the bin function and the bin results display on and off. Each bin is replaced with a horizontal line (—) when the function is off.

3.3.3 BIN BEEP

This option allows the user to select whether the unit will beep when a bin is determined. The user can select one of the following options:

- **OFF**: Turns off the bin beep function.
- **NG**: When the measurement result is different from the bin setting the beep will sound.
- **GD**: When the measurement result conforms to the bin setting the beep will sound.

3.3.4 NG COLOR & GD COLOR

The user can select what color will be displayed when the measurement is **NG** or **GD**. While the **NG COLOR** and **GD COLOR** settings can be set with the same color, it is recommended to use different colors to distinguish between a **NG** and **GD** measurement.

NG COLOR

- **OFF**: Nothing is displayed when the measurement result differs from the bin setting.
- **GREY**: When the measurement result differs from the bin setting, the corresponding bin will be displayed in grey.
- **RED**: When the measurement result differs from the bin setting, the corresponding bin will be displayed in red.
- **GREEN**: When the measurement result differs from the bin setting, the corresponding bin will be displayed in green.

GD COLOR

- **OFF**: Nothing is displayed when the measurement result is within the accepted values.
- **GREY**: When the measurement result conforms to the bin setting, the corresponding bin will be displayed in grey.
- **RED**: When the measurement result conforms to the bin setting, the corresponding bin will be displayed in red.
- **GREEN**: When the measurement result conforms to the bin setting, the corresponding bin will be displayed in green.

3.4 Statistics DisplayT

The Statistics Display (STATIS DISP) page calculates the statistical results of sampled measurements. Mean, standard deviation, min and max values among other statistical information are displayed. A sample is taken when the unit is triggered. To access the page press the **DISP** button and select **STATIS DISP** in menu options.

<STATIS DISP>		DATA	OPTIONS	CLEAR
Edge Mode ABS	Hi 89.250	Lo 80.750	Status ON	TRIG
Mean 84.515	Dev 22.097m	Var 0.00n	Cp 99.990	
CpK 99.990	Hi(num) 0	Lo(num) 0	In(num) 5	
Max 84.516	MaxIndex 2	Min 84.515	MinIndex 1	
R: 84.52 Ω num: 5		valn: 5		
Stat is started.Trig!				13:45:03

Figure 22 - Statistical Display

The following parameters are accessible from the Statistical Display:

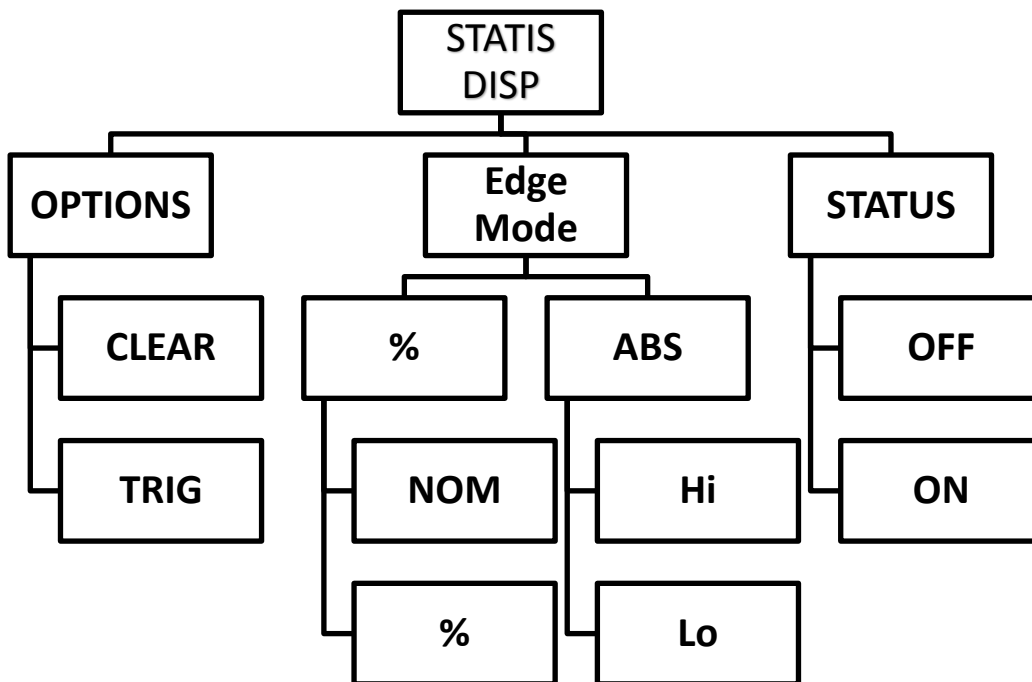

Figure 23 STATIS DISP Menu Tree

3.4.1 OPTIONS

The **OPTIONS** key allows the user to access the additional statistics options menu.

The measurement options are:

- **CLEAR:** Clear all statistical parameters.
- **TRIG:** Trigger measurement execution.

3.4.2 Edge Mode

The **Edge Mode** key allows the user to access two modes.

- **% (Percent Error):** The user can set the nominal value (**NOM**) and the percent error (**%**). If the nominal value is 100 and percentage is 10, the tolerance will be 100±10%. The instrument will compare the measured value to the tolerance and determine if the DUT is HI (above tolerance), LO (below tolerance), or IN (within tolerance).
- **ABS (Absolute):** The user can set absolute **HIGH** and **LOW** limits. The instrument will compare the measured values to the absolute limits and determine if the DUT is HI (above the upper limit), LO (below the lower limit), or IN (within limits).

3.4.3 Status

The **Status** key allows the user to turn the statistical calculations **OFF** and **ON**.

- **ON:** When ON is selected, all functions and buttons are disabled except the trigger and save screen functions. The instrument makes a statistical measurement at every trigger.
- **OFF:** When OFF is selected, the statistic measurements are disabled. All other functions and buttons are enabled.

3.4.4 Statistical Analysis Parameters

Parameter	Variable	Description	Formula
MEAN	\bar{x}	Average value	$\bar{x} = \frac{\sum x}{n}$
Dev	σ	Population Standard Deviation	$\sigma = \sqrt{\frac{\sum(x - \bar{x})^2}{n}}$
Var	σ_{n-1}	Sample Standard Deviation	$\sigma_{n-1} = \sqrt{\frac{\sum(x - \bar{x})^2}{n - 1}}$
Cp	C_p	Process Capability Index (Dispersion)	$C_p = \frac{ USL - LSL }{6\sigma_{n-1}}$
CpK	C_{pk}	Process Capability Index (Deviation)	$C_{pk} = \frac{ USL - LSL - USL + LSL - 2\bar{x} }{6\sigma_{n-1}}$

Table 2 - Statistical Analysis Parameters

NOTE: Variables in the above table:

n: The total number of samples.

x: Measurement results of each sample measurement. The data are saved in the instrument buffer memory.

USL: Upper specification limit. If NOM, % is 100±10% then *USL*= 110.

LSL: Lower specification limit. If NOM, % is 100±10% then *LSL* = 90.

When *Cp, Cpk* > 1.33, the working capacity is ideal.

When 1.33 ≥ *Cp, Cpk* > 1.00, the working capacity is sufficient.

When 1.00 ≥ *Cp, Cpk*, the working capacity is insufficient.

- **Hi**: Incremented when the measurement result exceeds the upper limit value *USL*.
- **Lo**: Incremented when the measurement result is less than the lower limit value *LSL*.
- **In**: Incremented when the measurement result is within the limits.
- **Max**: Maximum measurement result among the current data set.
- **MaxIndex**: Sample index number that corresponds to the maximum measurement result.
- **Min**: Minimum measurement result among the current data set.
- **MinIndex**: Sample index number that corresponds to the minimum measurement result.
- **R**: Measured resistance.
- **num**: Incremented every trigger, even when the source terminal is open.
- **v**: Incremented for every measurement recorded

Example: NOM, % is 100±10%

Sample Index	1	2	3	4	5	6	8
Result (Ω)	100.4	101.6	103.7	98.4	87.9	112.1	86.5

Results:

Hi = 1, Lo = 2, In = 5, Max = 112.1, MaxIndex = 6, Min = 86.5, MinIndex = 8

4 Setup Menus

The setup menus allow the user to have more control the measurement operations, functions, and calculations. The universal arrow keys along with the **ENTER** key can also be used to navigate the touchscreen. The setup page menus consists of a primary menu and a secondary menu shown to the right of the screen.

There are 3 setup pages:

1. Measurement Setup
2. Bin Setup
3. System Setup

4.1 Measurement Setup

The Measurement Setup (**MEAS SETUP**) page has additional measurement parameters. To access the page press the **SETUP** button and select **MEAS SETUP** in menu options. <MEAS SETUP> is the default setup page.



Figure 24 - Measurement Setup

The following parameters are accessible from the Measurement Setup page:

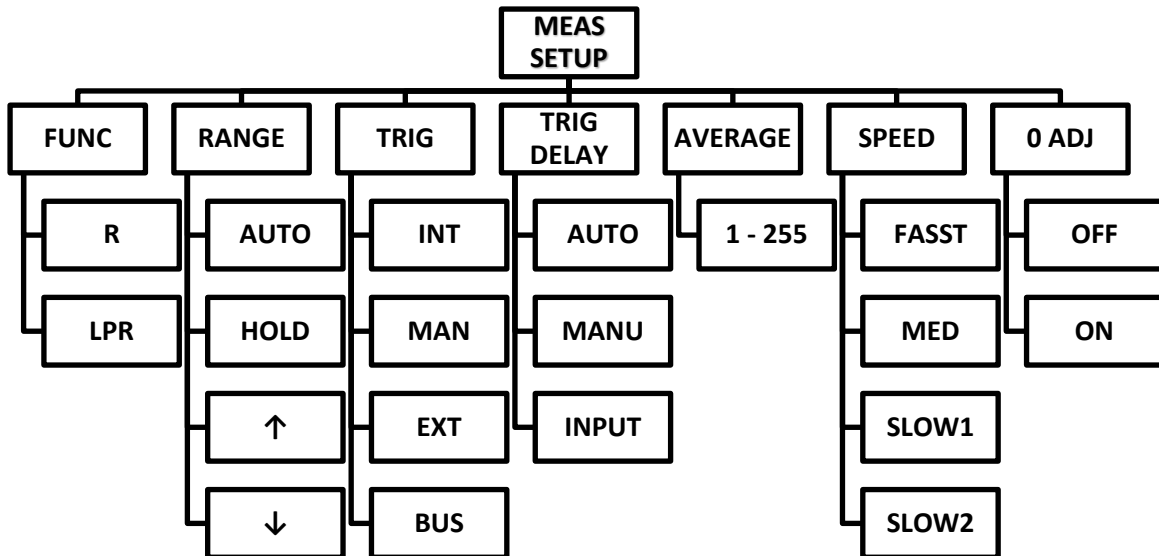

Figure 25 - MEAS SETUP Menu Tree

4.1.1 FUNC

This function is identical to **FUNC** on <MEAS DISP> page. See 3.1.2 for details.

4.1.2 RANGE

This function is identical to **RANGE** on <MEAS DISP> page. See 3.1.3 for details.

4.1.3 TRIG

Press **TRIG** to access the 4 trigger mode options:

- **INT**: (Internal), continuously tests the DUT and displays the result, (default mode).
- **MAN**: (Manual), press the **TRIGGER** button to test a DUT once and display the result.
- **EXT**: (External), trigger the instrument through the $\overline{\text{TRIG}}$ handler pin 1.
- **BUS**: Trigger the instrument through the COM interface with a software command.

Note: The instrument is in waiting mode until triggered in all trigger modes except INT

4.1.4 TRIG DELAY

The **TRIG DELAY** enables the user to select between **AUTO** and **MANU** (manual) modes. Automatic trigger delay is a maximum of 30 ms. To set a manual trigger delay:

1. Press **MANU**
2. Press **INPUT** to open the numeric keypad.

3. Use the keypad to enter the delay value. Manual trigger delay range is: 0 ms to 9999 ms.

Note: If delay time is set to 0 ms, the contact settling time detection cannot be executed. It is recommended to set the delay time to be greater than 1 ms.

4.1.5 AVERAGE

Press **AVERAGE** to open a numeric keypad. The user can set the average number a samples taken per trigger, ranging from 1 to 255. The larger the sample sizes reduces variation at the cost of a longer time to display the result.

4.1.6 SPEED

This function is identical to **SPEED** on **<MEAS DISP>** page. See 3.1.4 for details.

4.1.7 0 ADJ

Select the zero adjustment offset state. **OFF** will not include the offset in the measurement calculation. **ON** will include the offset in the measurement calculation. The offset value used for this setting is calculated after the cable calibration is completed. See 2.5 for details.

- 0 ADJ OFF: measured value + cable resistance will be displayed.
- 0 ADJ ON: measured value - cable resistance will be displayed.

Note: The Cable Calibration must be completed correctly before this feature can be used

4.2 Bin Setup

The **BIN SETUP** page is where the user can define the parameters for the 3 bins.

To access the page press the **SETUP** button and select **BIN SETUP** in menu options.



<BIN SETUP>		DATA	OPTIONS	BIN MODE ABS
BIN NO.	STATE	HIGH	LOW	BIN BEEP OFF
1	ON	0.0000u	0.0000u	BIN CLEAR
2	ON	85.000	80.000	
3	ON	0.0000u	0.0000u	

13:45:34

Figure 26 - Bin Setup

The following parameters are accessible from the Bin Setup page:

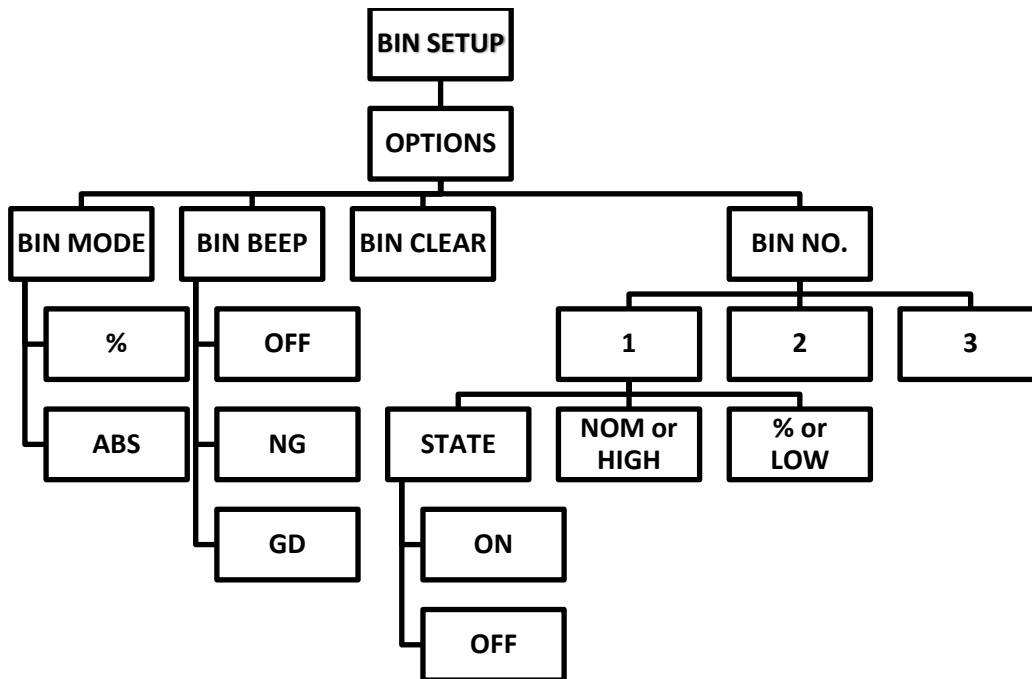

Figure 27 - BIN SETUP Menu Tree

4.2.1 OPTIONS

The **OPTIONS** key allows the user to access the additional bin setup options menu.

The options are:

- **BIN MODE**: Toggle between **%** (percentage error) and **ABS** (Absolute limits).
- **BIN BEEP**: Toggle between three bin beep modes: **OFF**, **NG** and **GD**.
- **BIN CLEAR**: Clear all setting parameters for all bins.

4.2.2 BIN 1 to 3

Press the bin number **1**, **2**, or **3** to display the **DEL** option. Press **DEL** to delete bin settings and set the state to **OFF**.

4.2.3 STATE

Press **STATE** to display the bin state as **ON** or **OFF**. When **ON** is set, the corresponding bin in the display zone will be shown as lighted circle. When **OFF** is set, the corresponding bin is shown as a horizontal line (—).

4.2.4 BIN MODE

The bin calculation is determined by the **BIN MODE**. Press the limit or value field to open a numeric keypad.

If **BIN MODE**: **ABS** is selected:

- **HIGH:** Input the high limit for DUT comparison.
- **LOW:** Input the low limit for DUT comparison.

If **BIN MODE: %** is selected:

- **NOM:** Input the nominal value.
- **%:** Input the percentage value.

4.3 System Setup

The **SYSTEM SETUP** page is where the user can change instrument settings. To access the page press the **SETUP** button and select **SYSTEM SETUP** in menu options.



Figure 28 - System Setup

The following parameters are accessible from the System Setup page:

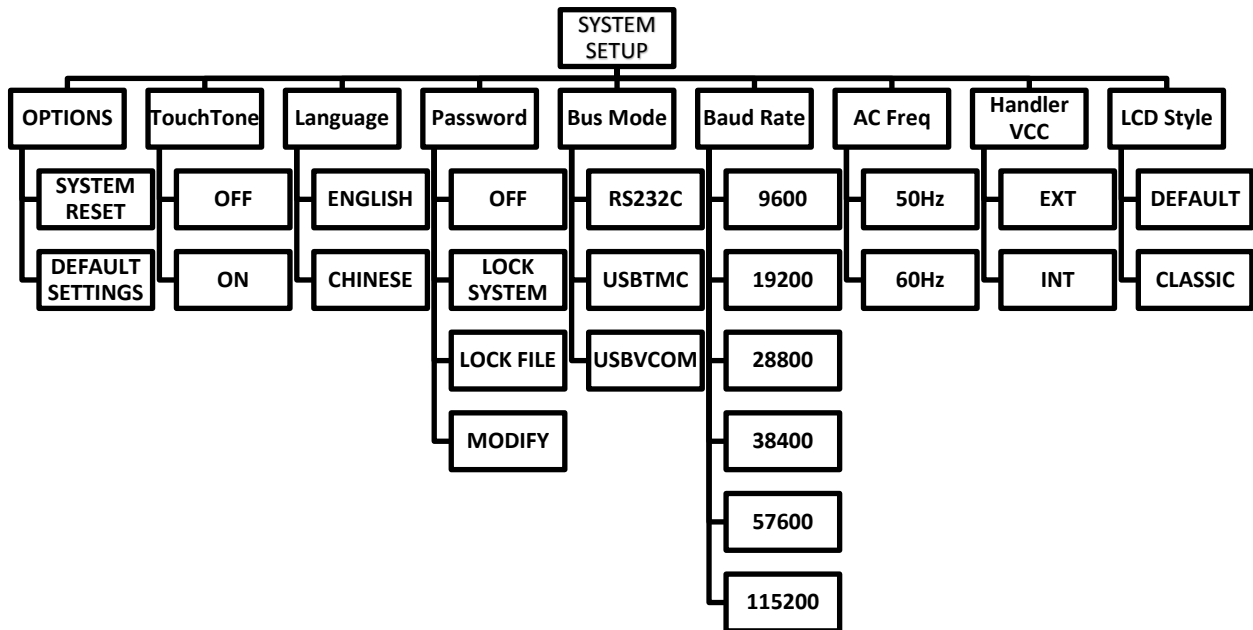

Figure 29 - SYSTEM SETUP Menu Tree

4.3.1 OPTIONS

The **OPTIONS** key allows the user to access the additional system setup options menu.

The options are:

- **SYSTEM RESET**: Performs a soft reset on the instrument.
- **DEFAULT SETTINGS**: Restores default settings:
 - Touch Tone: ON
 - Language: English
 - Password: OFF
 - Bus Mode: RS232C
 - Baud Rate: 9600
 - Handler VCC: INT
 - LCD Style: DEFAULT

4.3.2 Touch Tone

Press **Touch Tone** to select the touch tone **ON** or **OFF**. When selected **ON**, the tone is played when a touch screen key is touched or a button is pressed. **OFF** disables the tone.

4.3.3 Language

Press **Language** to select the displayed language, **ENGLISH** or **CHINESE**. The default language is English.

4.3.4 Password

Press **Password** to access the following menu options:

- **OFF**: Touch this key to turn off the password protection function. This function requires the user to input the current password to de-activate the password protection.
- **LOCK SYSTEM**: Touch this key to enable the password function. Please input the password which will be required when opening a file or starting up the instrument.
- **LOCK FILE**: It is necessary to input the password if this function is enabled.
- **MODIFY**: Touch this key to modify the password.

Steps for changing the password:

1. Touch **MODIFY** to open an alphanumeric keypad.
2. Input the original password and press **ENTER** to confirm.
3. Prompt: "Input password"
4. Input the new password and press **ENTER** to confirm.
5. Prompt: "New password"
6. Input the new password a second time and press **ENTER** to confirm.
7. Prompt: "Confirm new password"
8. The <SYSTEM SETUP> page will be displayed and the password modification is complete.
9. Prompt: "Password modify ok"

Note: The default password is 2516.

4.3.5 Bus Mode

Press **Bus Mode** to select the communication interface in the menu options. All interfaces are accessible on the rear panel.

- **RS232C**
- **USBTMC**
- **USBVCOM**

4.3.6 Baud Rate

Press **Baud Rate** to select from the following six baud rates:

- 9600

- 19200
- 28800
- 38400
- 57600
- 115200

4.3.7 AC Frequency

Press **AC Freq** to select the power supply frequency: **50Hz** or **60Hz**. Selecting the correct frequency reduces the power line noise's influence on the instrument.

4.3.8 Handler VCC

Press **Handler VCC** to select **INT**ernal or **EXT**ernal power supply for the handler output.

4.3.9 Setting Time and Date

Touch the time or date digits to open the modification menu.

For example: 9 o'clock 13 minute and 25 second a.m. on November 12, 2010 will be shown as 10-11-12 09:13:25.

Operations are as follows: Touch the time zone to be modified, the following items will be displayed.

- **++**: Increment by 5.
- **+**: Increment by 1.
- **-**: Decrement by 1.
- **--**: Decrement by 5.
- **<<**: Cursor under the time date move left.
- **>>**: Cursor under the time date move right.

Bus Addr and **RS485** are not supported.

5 FILE MANAGER

The file manager menu is used to save and load parameter configuration files (.STA) set by the user. These files can be saved to the internal (I) non-volatile memory or externally (E) to a USB flash drive. Insert an empty USB flash drive to the front panel USB port and wait for the drive to initialize (about five seconds).



Figure 30 - File Manager

To access the file manager menu:

1. Press the **FILE** button or select the **DATA** key that can be found on all display pages, then select **FILE**.
2. Press **<INTERNAL FILE>** or **<EXTERNAL FILE>** to navigate between screens.

5.1 File Structure

The internal non-volatile memory can store up to 30 STA files. The following folder structure is automatically created on a USB flash drive when an external USB flash drive is connected.

Folder	Maximum Amount of File	Description
CSV	1	Measurement results, *.CSV file.
STA	40	Configuration data, *.STA file.
PIC	999	Screen capture, *.gif file.

Table 3 - Folders Generated in USB

5.1.1 Saving Configuration Files

1. Navigate to the FILE MANAGER screen.
2. Select desired destination, **INTERNAL FILE** or **EXTERNAL FILE** (if USB is attached).
3. Select a file slot or press **Page #** to navigate **PAGE UP** or **PAGE DOWN** to show the next 4 file slots.

4. Select **SAVE**. If an existing STA file is select, it will be overwritten.
5. Select **YES** to continue. Select **NO** to cancel.
6. An alphanumeric keypad will open. Type in desired file name. Press **Enter**. Or **Esc** to cancel.

5.1.2 Load Configuration Files

1. Navigate to the FILE MANAGER screen.
2. Select desired destination, **INTERNAL FILE** or **EXTERNAL FILE** (if USB is attached).
3. Select an STA file or press **Page #** to navigate **PAGE UP** or **PAGE DOWN** to show the next 4 file slots.
4. Select **LOAD**.
5. Select **YES** to continue. Select **NO** to cancel.

5.1.3 Delete File

1. Navigate to the FILE MANAGER screen.
2. Select desired destination, **INTERNAL FILE** or **EXTERNAL FILE** (if USB is attached).
3. Select an STA, GIF, or CSV file or press **Page #** to navigate **PAGE UP** or **PAGE DOWN** to show the next 4 file slots.
4. Select **DELETE**.
5. Select **YES** to continue. Select **NO** to cancel.

5.1.4 Copy File to I:/E:

1. Navigate to the FILE MANAGER screen.
2. Select desired destination, **INTERNAL FILE** or **EXTERNAL FILE** (if USB is attached).
3. Select an STA file or press **Page #** to navigate **PAGE UP** or **PAGE DOWN** to show the next 4 file slots.
4. Select **COPY TO I:/E:**. This will move the STA from internal to external memory or external to internal memory.
5. Select **YES** to continue. Select **NO** to cancel.

5.1.5 Select

Use **SELECT** to copy multiple files at once from internal to external memory. Press **SELECT** again on a file to deselect it.

5.2 SCREEN COPY

This function can be found in the **DATA** menu on most displays. Press SAVE SCREEN and a screenshot will be saved in the PIC folder mentioned above. The name assigned to the screenshot will start at zero, but if there are other screenshots from this units in that folder, it will assign the lowest value possible.

5.3 SAVE DATA

Enabled when a USB flash drive is attached. When activated, resistance data is continuously saved to an auto-generated CSV onto the drive. The key changes to **OFF** to terminate the function. **ON** is disabled if no USB flash drive is attached.

The CSV header is: R,COMP,DEV,BIN1,BIN2,BIN3,COUNT,VCOUNT,STAT,Time

NOTICE

Removing the USB flash drive before pressing STOP SAVE will result in the loss of the recorded data.

5.4 USB Flash Driver Requirements

The instrument features a USB host interface for connecting an external USB flash drive. Below lists the requirements of the USB flash drive as supported by the instrument:

- Meets the USB 1.0/1.1 standard
- Capacity: 32MB/256MB/2GB/4GB
- File format: FAT16, FAT32 (Format the USB memory from a Windows® operating system)

6 Specifications

All specifications apply to the unit after:

Temperature Stabilization time: 30 mins

Operating Temperature: 23 °C ± 5 °C

Relativity Humidity: ≤ 80%

Specifications are subject to change without notice.

Rd = Measured Value

Fs = Full range

Resistance Measurement				
Reading Digits	4 ½ digits			
Measurement Range	1 mΩ to 20 kΩ			
Resistance Range	Test Current	Resolution	Accuracy Rd % + digits	Open Circuit Voltage
20 mΩ	1 A	1 μΩ	0.1 + 3	0.7 V
200 mΩ	100 mA	10 μΩ		
2 Ω	100 mA	100 μΩ		
20 Ω	10 mA	1 mΩ	0.1 + 2	3 V
200 Ω	1 mA	10 mΩ		
2 kΩ	100 μA	100 mΩ		
20 kΩ	100 μA	1 Ω		
LPR Resistance Measurement				
2 Ω	10 mA	100 μΩ	0.2 + 5	40 mV
20 Ω	1 mA	1 mΩ		
200 Ω	100 μA	10 mΩ		
2 kΩ	10 μA	100 mΩ		

*Accuracy = (measurement value * Rd%) + (least significant digit)*

Example calculation:

Measurement = 10.404 Ω; RANGE = 20 Ω

*Accuracy = (10.404 Ω * 0.1%) + 0.002 = 0.012404 Ω*

Result: 10.404 Ω ± 0.012 Ω

Display Digits		
	SLOW2, SLOW1, MED	FAST
Display Digits	5 digits	4 digits
Measurement Function		
Resistance Measurement Time	FAST: 10 ms, MED: 25 ms, SLOW1: 115 ms, SLOW2: 455 ms (+20 ms when DISPLAY is ON)	
Low Voltage Measurement (LPR)	Open voltage ≤ 40 mV Effective range: 2 Ω , 20 Ω , 200 Ω , 2 k Ω	
Average Samples	1 to 255	
General specification		
External USB memory	Save / recall configuration files, screenshots, and measurement logs	
Remote interface	USB (USBTMC or virtual COM), RS232, Handler	
Display	24-bit, 400 x 272 touch TFT LCD screen	
Operating Temperature, Humidity	0 °C to 40 °C, $\leq 80\%$ RH	
Temperature, Humidity for basic accuracy	23 \pm 5 °C, $\leq 80\%$ RH	
Storage Temperature, Humidity	5°C to 40 °C, $\leq 85\%$ RH	
AC Input	Voltage	110 V to 240 V ($\pm 10\%$)
	Frequency	50 Hz to 60 Hz ($\pm 5\%$)
Power Consumption	≤ 30 VA	
Dimensions (WxHxD)	255 mm x 110 mm x 361 mm (10.04 in x 4.33 in x 14.22 in) (with bezel)	
Weight	Approx. 3.9 kg	

6.1 Timing

The measurement speed of the instrument is determined by the following factors:

- Integral sampling period (approx. 5ms)
- Average times (measurement times)
- Measurement delay time (a time starting from the measurement start-up to the measurement beginning)
- Display on/off

Measurement Timing	
FAST	10 ms

MED	25 ms
SLOW1	115 ms
SLOW2	455 ms
Display On	+20 ms
Computing Time	1 ms

Table 4 - Typical Measuring Times

7 Remote Control

The instrument has RS232 and USB (virtual COM) for remote control. This chapter will describe how users can remotely operate the instrument and use SCPI (Standard Commands for Programmable Instruments) commands via these interfaces. **4.3.5 Bus Mode** must be in the respective interface mode in order to communicate.

7.1 RS232C

For RS232C connectivity, refer to the diagram below for the pinout information. The RS232C is labeled in the rear panel and is a female DB-9 interface. Use a null modem or crossover cable where pins 2 and 3 are reversed.

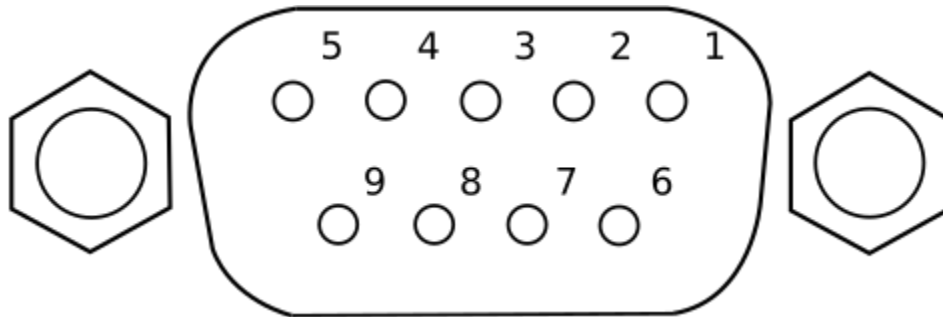

Pin	Description
1	-
2	Transmit Data
3	Receive Data
4	-
5	GND
6	-
7	-
8	-
9	-

Table 5 - RS232 Pinout

Parameter	Description
Baud rate	9600, 19200, 28800, 38400, 48000, 57600, and 115200.
Parity and data bit	None/8 bits
Stop bit	1
Flow control	None

Table 6 - RS232 Parameters

NOTICE

The RS232C interface does not support hardware flow control (only transmit, receive, and ground pins are used). The programmer should be aware of this communication error. Therefore, limitation and notice the command process time of the instrument. If the remote commands are sent too fast to the instrument, the internal buffer may overrun and cause a adding a delay between commands may be necessary to allow time for the meter to process.

7.2 USBTMC

USB The standard USB port is a USBTMC-compliant port that can be used for remote communication. There are no additional settings in the menu system for USB configuration. The only requirement is that the USBTMC driver be installed. It is included when a VISA software is installed on the computer.

(We recommend using NI-VISA, which can be downloaded at <http://www.ni.com/visa/>).

7.3 USB (USBCDC - Virtual COM)

The standard USB port is a virtual COM port that can be used for remote communication. There are no settings in the menu system for USB configuration. The settings are the same as the settings for RS232C.

NOTICE

The USB interface does not support hardware flow control (only transmit, receive, and ground pins are used). The programmer should be aware of this limitation and notice the command process time of the instrument. If the remote commands are sent too fast to the instrument, the internal buffer may overrun and cause a communication error. Therefore, adding a delay between commands may be necessary to allow time for the meter to process.

7.4 Remote Commands

The instrument supports some SCPI commands and some instrument specific commands. These commands enable a computer to remotely communicate and control the instrument over any of the supported remote interfaces: USBTMC and RS232C.

Refer to the programming manual for details available at www.bkprecision.com

8 Handler Interface

The instrument is equipped with a 9 pin Handler interface for external control and outputting measurement and sorting results.

Terminals and Descriptions:

Mating connector: Amphenol PN: L77S-DE09S Hood: 17E-1724-1

Pin	IO	Name	Description
1	In	TRIG	Trigger signal, falling edge is valid. When the instrument is in the EXTERNAL trigger mode and this signal is valid, the instrument will trigger a measurement.
2	Out	PASS2 (P2)	Low Bin 2 comparison result output
3	Out	FAIL	The low bin comparison result output signal will be valid.
4	Power	+5V	Internal 5V power output
5	Power	EXT_VCC	When Handler VCC is set to EXTERNAL, the output requires an external power source, +5V to +30V. When Handler VCC is set to INTERNAL, the pin is shorted to the internal 5V power output.
6	Out	PASS1 (P1)	Low Bin 1 comparison result output
7	Out	PASS3 (P3)	Low Bin 3 comparison result output
8	Out	EOC	Measurement end signal.
9	Power	EXT_GND	When the "Handler" power supply is set as "External", the terminal is external GND; when the "Handler" power supply is set as "Internal", the terminal is internal GND.

Table 7 - Handler Pinout

8.1 Handler Sequence

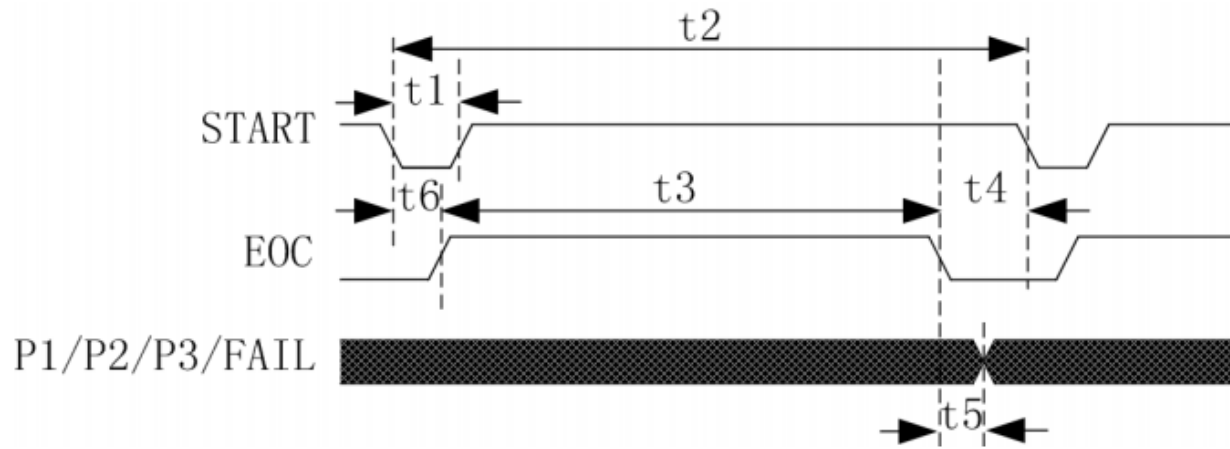

Figure 31 - Handler Output Timing Diagram

Time	Minimum Duration
t1: trigger pulse width	1 ms
t2: measurement time at one time	t3 + t4
t3: sampling time of one measurement	1 sampling time
t4: data processing and display time of one measurement	Display ON: 20 ms Display OFF: 5 ms
t5: end of sampling to control output time	2ms
t6: measurement delay time	See the setup for measurement delay

Table 8 - Handler Timing

8.2 Isolated Output

Each input and output signal is isolated by a photoelectric coupler. The output voltage of each line is determined by the connection between a pull-up resistor and an externally applied voltage (EXT_VCC).

The output circuit is shown as follows:

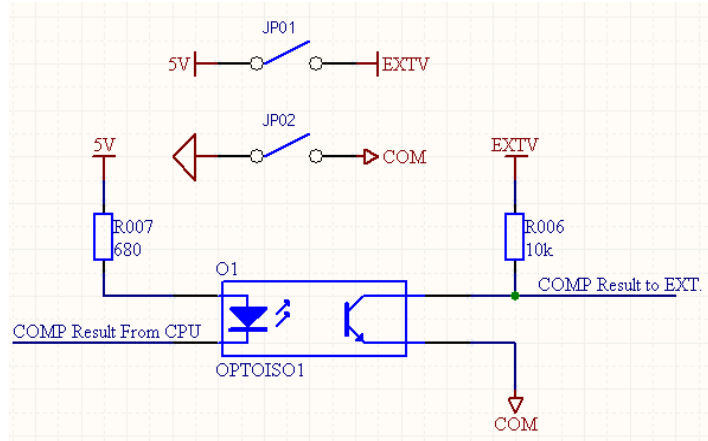

Figure 32 - Output Circuit

External control input circuit is shown as follows:

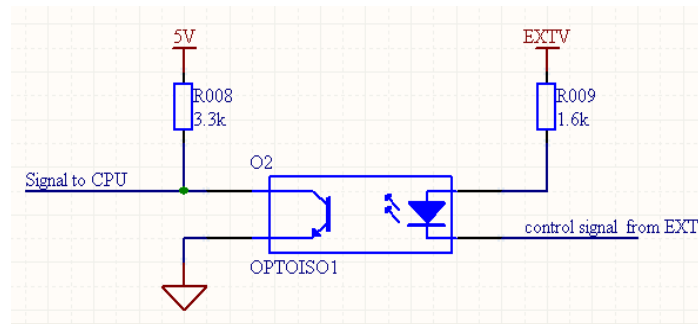

Figure 33 - Input Circuit

9 SERVICE INFORMATION

Warranty Service: Please go to the support and service section on our website at www.bkprecision.com to obtain a RMA #. Return the product in the original packaging with proof of purchase to the address below. Clearly state on the RMA the performance problem and return any leads, probes, connectors and accessories that you are using with the device.

Non-Warranty Service: Please go to the support and service section on our website at www.bkprecision.com to obtain a RMA #. Return the product in the original packaging to the address below. Clearly state on the RMA the performance problem and return any leads, probes, connectors and accessories that you are using with the device. Users not on an open account must include payment in the form of a money order or credit card. For the most current repair charges please refer to the service and support section on our website.

Return all merchandise to B&K Precision Corp. with prepaid shipping. The flat-rate repair charge for Non-Warranty Service does not include return shipping. Return shipping to locations in North America is included for Warranty Service. For overnight shipments and non-North American shipping fees please contact B&K Precision Corp.

B&K Precision Corp.

22820 Savi Ranch Parkway

Yorba Linda, CA 92887

www.bkprecision.com

714-921-9095

Include with the returned instrument your complete return shipping address, contact name, phone number and description of problem.

10 LIMITED THREE-YEAR WARRANTY

B&K Precision Corp. warrants to the original purchaser that its products and the component parts thereof, will be free from defects in workmanship and materials for a period of **three years** from date of purchase.

B&K Precision Corp. will, without charge, repair or replace, at its option, defective product or component parts. Returned product must be accompanied by proof of the purchase date in the form of a sales receipt.

To help us better serve you, please complete the warranty registration for your new instrument via our website www.bkprecision.com

Exclusions: This warranty does not apply in the event of misuse or abuse of the product or as a result of unauthorized alterations or repairs. The warranty is void if the serial number is altered, defaced or removed.

B&K Precision Corp. shall not be liable for any consequential damages, including without limitation damages resulting from loss of use. Some states do not allow limitations of incidental or consequential damages. So the above limitation or exclusion may not apply to you.

This warranty gives you specific rights and you may have other rights, which vary from state-to-state.

B&K Precision Corp.
22820 Savi Ranch Parkway
Yorba Linda, CA 92887
www.bkprecision.com
714-921-9095



22820 Savi Ranch Parkway

Yorba Linda, CA 92887

www.bkprecision.com

© 2017 B&K Precision Corp.

Printed in China

v081518

BK PRECISION®

2841 DC Resistance Meter

USER MANUAL



Safety Summary

The following safety precautions apply to both operating and maintenance personnel and must be followed during all phases of operation, service, and repair of this instrument.

WARNING

Before applying power to this instrument:

- Read and understand the safety and operational information in this manual.
- Apply all the listed safety precautions.
- Verify that the voltage selector at the line power cord input is set to the correct line voltage. Operating the instrument at an incorrect line voltage will void the warranty.
- Make all connections to the instrument before applying power.
- Do not operate the instrument in ways not specified by this manual or by B&K Precision.

Failure to comply with these precautions or with warnings elsewhere in this manual violates the safety standards of design, manufacture, and intended use of the instrument. B&K Precision assumes no liability for a customer's failure to comply with these requirements.

Category Rating

The IEC 61010 standard defines safety category ratings that specify the amount of electrical energy available and the voltage impulses that may occur on electrical conductors associated with these category ratings. The category rating is a Roman numeral of I, II, III, or IV. This rating is also accompanied by a maximum voltage of the circuit to be tested, which defines the voltage impulses expected and required insulation clearances. These categories are:

Category I (CAT I): Measurement instruments whose measurement inputs are not intended to be connected to the mains supply. The voltages in the environment are typically derived from a limited-energy transformer or a battery.

Category II (CAT II): Measurement instruments whose measurement inputs are meant to be connected to the mains supply at a standard wall outlet or similar sources. Example measurement environments are portable tools and household appliances.

Category III (CAT III): Measurement instruments whose measurement inputs are meant to be connected to the mains installation of a building. Examples are measurements inside a building's circuit breaker panel or the wiring of permanently-installed motors.

Category IV (CAT IV): Measurement instruments whose measurement inputs are meant to be connected to the primary power entering a building or other outdoor wiring.

WARNING

Do not use this instrument in an electrical environment with a higher category rating than what is specified in this manual for this instrument.

WARNING

You must ensure that each accessory you use with this instrument has a category rating equal to or higher than the instrument's category rating to maintain the instrument's category rating. Failure to do so will lower the category rating of the measuring system.

Electrical Power

This instrument is intended to be powered from a CATEGORY II mains power environment. The mains power should be 120 V RMS or 240 V RMS. Use only the power cord supplied with the instrument and ensure it is appropriate for your country of use.

Changing Line Voltage

WARNING

Disconnect all cables including the power cord from the instrument when changing the instrument's line voltage. After changing the line voltage setting, ensure the instrument has fuses of the proper ratings and types for the selected line voltage before applying line power.

Ground the Instrument

WARNING

To minimize shock hazard, the instrument chassis and cabinet must be connected to an electrical safety ground. This instrument is grounded through the ground conductor of the supplied, three-conductor AC line power cable. The power cable must be plugged into an approved three-conductor electrical outlet. The power jack and mating plug of the power cable meet IEC safety standards.

WARNING

Do not alter or defeat the ground connection. Without the safety ground connection, all accessible conductive parts (including control knobs) may provide an electric shock. Failure to use a properly-grounded approved outlet and the recommended three-conductor AC line power cable may result in injury or death.

WARNING

Unless otherwise stated, a ground connection on the instrument's front or rear panel is for a reference of potential only and is not to be used as a safety ground.

WARNING

Probes and Test Leads

- If the instrument is used with test leads or probes, the test leads or probes must have a safety category rating at least as high as that of the instrument to maintain the instrument's safety category rating.
- Use only probes that have finger-guards that prevent fingers from slipping down the probe body and contacting the probe's conductor.
- Inspect the probe or test leads for damage before using them. If you suspect a probe or test lead is damaged, remove it from service, mark it as unusable, and return to B&K Precision for maintenance service.
- Do not connect or disconnect test leads or probes from a circuit while that circuit is connected to a voltage source or may have non-discharged energy storage devices.
- Connect the probe or test leads to the measurement instrument before connecting them to the circuit to be tested. Disconnect the probe or test leads from the circuit to be tested before disconnecting them from the measurement instrument.
- For probes that have a voltage reference lead (for example, scope probes with a "ground lead"), connect the voltage reference lead only to conductors that are at ground potential.
- Do not use the probe or test leads in a condensing environment or where flammable materials (for example, dust, chemicals, or vapors) are present.
- Clean the probes or test leads only as instructed in their operating manuals.

Do not operate in an explosive or flammable atmosphere

WARNING

Do not operate the instrument in the presence of flammable gases or vapors, fumes, or finely-divided particulates.

WARNING

The instrument is designed to be used in office-type indoor environments. Do not operate the instrument

- In the presence of noxious, corrosive, or flammable fumes, gases, vapors, chemicals, or finely-divided particulates.
- In relative humidity conditions outside the instrument's specifications.
- In environments where there is a danger of any liquid being spilled on the instrument or where any liquid can condense on the instrument.
- In air temperatures exceeding the specified operating temperatures.
- In atmospheric pressures outside the specified altitude limits or where the surrounding gas is not air.
- In environments with restricted cooling air flow, even if the air temperatures are within specifications.
- In direct sunlight.

CAUTION

This instrument is intended to be used in an indoor pollution degree 2 environment. The operating temperature range is 0 °C to 40 °C and the operating humidity is ≤ 80 % relative humidity, with no condensation allowed.

Measurements made by this instrument may be outside specifications if the instrument is used in non-office-type environments. Such environments may include rapid temperature or humidity changes, sunlight, vibration and/or mechanical shocks, acoustic noise, electrical noise, strong electric fields, or strong magnetic fields.

Do not operate instrument if damaged

WARNING

If the instrument is damaged, appears to be damaged, or if any liquid, chemical, or other material gets on or inside the instrument, remove the instrument's power cord, remove the instrument from service, label it as not to be operated, and return the instrument to B&K Precision for repair. Notify B&K Precision of the nature of any contamination of the instrument.

Clean the instrument only as instructed

WARNING

Do not clean the instrument, its switches, or its terminals with contact cleaners, abrasives, lubricants, solvents, acids/bases, or other such chemicals. Clean the instrument only with a clean dry lint-free cloth or as instructed in this manual.

Not for critical applications

WARNING

This instrument is not authorized for use in contact with the human body or for use as a component in a life-support device or system.

Do not touch live circuits

WARNING

Instrument covers must not be removed by operating personnel. Component replacement and internal adjustments must be made by qualified service-trained maintenance personnel who are aware of the hazards involved when the instrument's covers and shields are removed. Under certain conditions, even with the power cord removed, dangerous voltages may exist when the covers are removed. To avoid injuries, always disconnect the power cord from the instrument, disconnect all other connections (for example, test leads, computer interface cables, etc.), discharge all circuits, and verify there are no hazardous voltages present on any conductors by measurements with a properly-operating voltage-sensing device before touching any internal parts. Verify the voltage-sensing device is working properly before and after making the measurements by testing with known-operating voltage sources and test for both DC and AC voltages. Do not attempt any service or adjustment unless another person capable of rendering first aid and resuscitation is present.

Do not insert any object into an instrument's ventilation openings or other openings.

WARNING

Hazardous voltages may be present in unexpected locations in circuitry being tested when a fault condition in the circuit exists.

Fuse Replacement

⚠ WARNING

Fuse replacement must be done by qualified service-trained maintenance personnel who are aware of the instrument's fuse requirements and safe replacement procedures. Disconnect the instrument from the power line before replacing fuses. Replace fuses only with new fuses of the fuse types, voltage ratings, and current ratings specified in this manual or on the back of the instrument. Failure to do so may damage the instrument, lead to a safety hazard, or cause a fire. Failure to use the specified fuses will void the warranty.

Servicing

⚠ CAUTION

Do not substitute parts that are not approved by B&K Precision or modify this instrument. Return the instrument to B&K Precision for service and repair to ensure that safety and performance features are maintained.

ESD Sensitivity

⚠ CAUTION

This product uses components which can be damaged by electrostatic discharge (ESD). To avoid damage, follow proper procedures for handling, storing and transporting parts and subassemblies which contain ESD-sensitive components.

Cooling Fans

⚠ CAUTION

This instrument contains one or more cooling fans. For continued safe operation of the instrument, the air inlet and exhaust openings for these fans must not be blocked nor must accumulated dust or other debris be allowed to reduce air flow. Maintain at least 25 mm clearance around the sides of the instrument that contain air inlet and exhaust ports. If mounted in a rack, position power devices in the rack above the instrument to minimize instrument heating while rack mounted. Do not continue to operate the instrument if you cannot verify the fan is operating (note some fans may have intermittent duty cycles). Do not insert any object into the fan's inlet or outlet.

For continued safe use of the instrument

- Do not place heavy objects on the instrument.
- Do not obstruct cooling air flow to the instrument.
- Do not place a hot soldering iron on the instrument.
- Do not pull the instrument with the power cord, connected probe, or connected test lead.
- Do not move the instrument when a probe is connected to a circuit being tested.

Compliance Statements

Disposal of Old Electrical & Electronic Equipment (Applicable in the European Union and other European countries with separate collection systems)

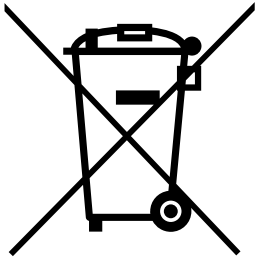

This product is subject to Directive 2002/96/EC of the European Parliament and the Council of the European Union on waste electrical and electronic equipment (WEEE), and in jurisdictions adopting that Directive, is marked as being put on the market after August 13, 2005, and should not be disposed of as unsorted municipal waste. Please utilize your local WEEE collection facilities in the disposition of this product and otherwise observe all applicable requirements.

CE Declaration of Conformity

This instrument meets the requirements of the Low Voltage Directive, 2006/95/EC and Electromagnetic Compatibility Directive, 2004/108/EC using the standards referenced below:









Low Voltage

- EN 61010-1:2010
- EN 61010-2-030:2010

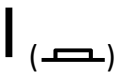
EMC Directive

- EN 61326-1:2013
- EN 61000-3-2:2006+A1:2009+A2:2009
- EN 61000-3-3:2008

Safety Symbols

	Refer to the user manual for warning information to avoid hazard or personal injury and prevent damage to instrument.
	Electric Shock hazard
	On (Supply). This is the AC mains connect/disconnect switch on the front of the instrument.
	Off (Supply). This is the AC mains connect/disconnect switch on the front of the instrument.
	Protective earth ground
	CAUTION indicates a hazardous situation which, if not avoided, will result in minor or moderate injury
	WARNING indicates a hazardous situation which, if not avoided, could result in death or serious injury
	DANGER indicates a hazardous situation which, if not avoided, will result in death or serious injury.
	NOTICE is used to address practices not related to physical injury.

Notations

TEXT – Denotes a softkey.

TEXT – Denotes a front panel button.

Table of Contents

1.1	Product Overview	78
1.2	Package Contents	78
1.3	Dimensions	79
1.4	Front Panel Overview	80
1.5	Rear Panel Overview.....	81
1.6	Keypad Overview	82
1.7	Display Overview	83
2.1	Input Power Requirements	84
2.2	Fuse Requirements	84
2.3	Input Connections	85
2.4	Preliminary Check.....	86
2.5	Cable Calibration	87
3.1	Measurement Display.....	90
3.1.1	OPTIONS	91
3.1.2	FUNC.....	92
3.1.3	RANGE	92
3.1.4	SPEED.....	93
3.1.5	TC/ Δt	93
3.2	Comparator Display	94
3.2.1	OPTIONS	95
3.2.2	COMP.....	95
3.2.3	COMP MODE	95
3.3	Bin Display	96

3.3.1	OPTIONS	97
3.3.2	BIN	97
3.3.3	BIN BEEP	97
3.3.4	NG COLOR & GD COLOR	97
3.4	Statistics Display	98
3.4.1	OPTIONS	99
3.4.2	EdgeMode	99
3.4.3	Status	99
3.4.4	Statistical Analysis Parameters	100
4.1	Measurement Setup	102
4.1.1	mR + b	103
4.1.2	FUNC	103
4.1.3	RANGE	103
4.1.4	TRIG	103
4.1.5	TRIG DELAY	104
4.1.6	AVERAGE	104
4.1.7	200m Ω	104
4.1.8	DETECT	104
4.1.9	Meas Mode	105
4.1.10	Adjust	105
4.2	Temperature Compensation (TC/ Δ t) Setup	105
4.2.1	Parameter Settings	106
4.2.2	TC/ Δ t	106
4.2.3	Types of Temperature Sensors	107
4.2.4	Temperature Correction (TC) Function	107
4.2.5	Temperature Conversion (Δ t) Function	107
4.2.6	Analog Input	108
4.3	BIN SETUP	109
4.3.1	OPTIONS	110
4.3.2	BIN NO.	110
4.3.3	BIN 0 to 9	110
4.3.4	STATE	110
4.3.5	BIN MODE	110
4.4	SYSTEM SETUP	111
4.4.1	OPTIONS	111
4.4.2	TouchTone	112
4.4.3	Language	112
4.4.4	Password	112

4.4.5	Bus Mode	113
4.4.6	Baud Rate	113
4.4.7	EOC Signal.....	113
4.4.8	Err.OUT signal.....	114
4.4.9	Setting Time and Date	115
4.5	LAN SETUP	115
5.1	File Structure	117
5.1.1	Saving Configuration Files	117
5.1.2	Load Configuration Files.....	118
5.1.3	Delete File.....	118
5.1.4	Copy File to I:/E:	118
5.1.5	Select	118
5.2	SAVE SCREEN	119
5.3	USB Flash Driver Requirements.....	119
6.1	Specifications.....	120
6.2	Basic Accuracy for Resistance Measurement.....	121
6.3	Resistance Measurement at Low Voltage Basic Accuracy	122
6.4	Timing	123
6.5	Accuracy for Temperature Measurement (TPTC2)	124
6.6	Accuracy for Temperature Measurement (Analog Input).....	124
7.1	RS232C.....	125
7.2	USBTMC.....	126
7.3	USB (USBCDC - Virtual COM)	126
7.4	LAN (Ethernet)	127
7.5	Remote Commands	127
8.1	Input Signals.....	128
8.2	Output Signal	131
8.3	Power and Ground.....	131
8.4	Isolated Output.....	132

1 General Information

1.1 Product Overview

The BK Precision's 2841 DC Resistance Meter is can handle a broad range of resistances measurements. Its maximum accuracy of 0.01% and its range, 0.1 $\mu\Omega$ to 110 M Ω are vividly displayed on the color LCD touchscreen in 5½ digits. The 2841 is ideal for testing resistances found in PCBs, conductors, relay contacts, interconnections, welding-holes as well as resistors and bigger components. In addition, the 2841 is capable of accurately measuring temperature-sensitive resistors due to its temperature correction and conversion functions. The statistical analysis function provides the average, maximum, minimum, population standard deviation and sample standard deviation of the measured datasets. The statistical analysis can also provide the Process Capability Index (Cp, Cpk) which indicates the ability of a process to produce an output within the user's specification limits.

Features:

- Measurement Range: 0.1 $\mu\Omega$ to 110 M Ω
- Minimum resolution: 0.1 $\mu\Omega$
- Maximum accuracy: 0.01%
- Temperature accuracy: 0.1°C
- Multiple measurement combinations of R, LPR, T
- Temperature Correction (TC) and Temperature Conversion(Δt)
- Offset Voltage Compensation (OVC)
- Bin sorting comparator with up to 10 bins
- Process Capability Index (Cp)
- Standard USB, RS232C, and LAN interface
- Intelligent detection for test state error
- Handler interface for on-line operation.
- 4.3" LCD touchscreen, 480x272 resolution

1.2 Package Contents

Please inspect the instrument mechanically and electrically upon receiving it. Unpack all items from the shipping carton, and check for any obvious signs of physical damage that may have occurred during transportation. Report any damage to the shipping agent immediately. Save

the original packing carton for possible future reshipment. Every instrument is shipped with the following contents:

1 x 2841 Series DC Resistance meter

1 x 4-terminal Kelvin test clips

1 x Temperature Probe

1 x AC Power Cord

1 x Certificate of Calibration

1 x Test Report

Verify that all items above are included in the shipping container. If anything is missing, please contact B&K Precision.

Note: User manual is available for download at www.bkprecision.com

1.3 Dimensions

The 2841 dimensions are approximately: 255 mm x 110 mm x 361 mm (10.04 in x 4.33 in x 14.22 in) (W x H x D).

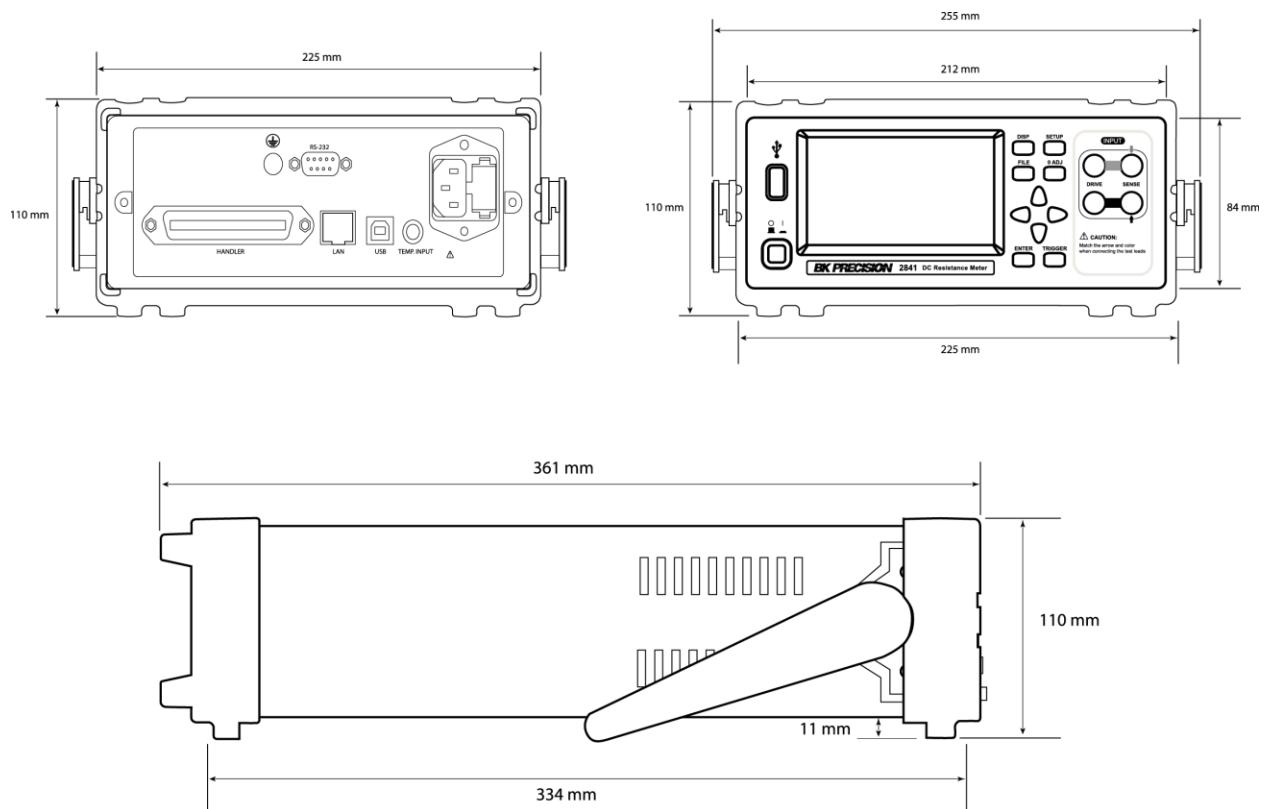

Figure 34 - Dimensions

1.4 Front Panel Overview

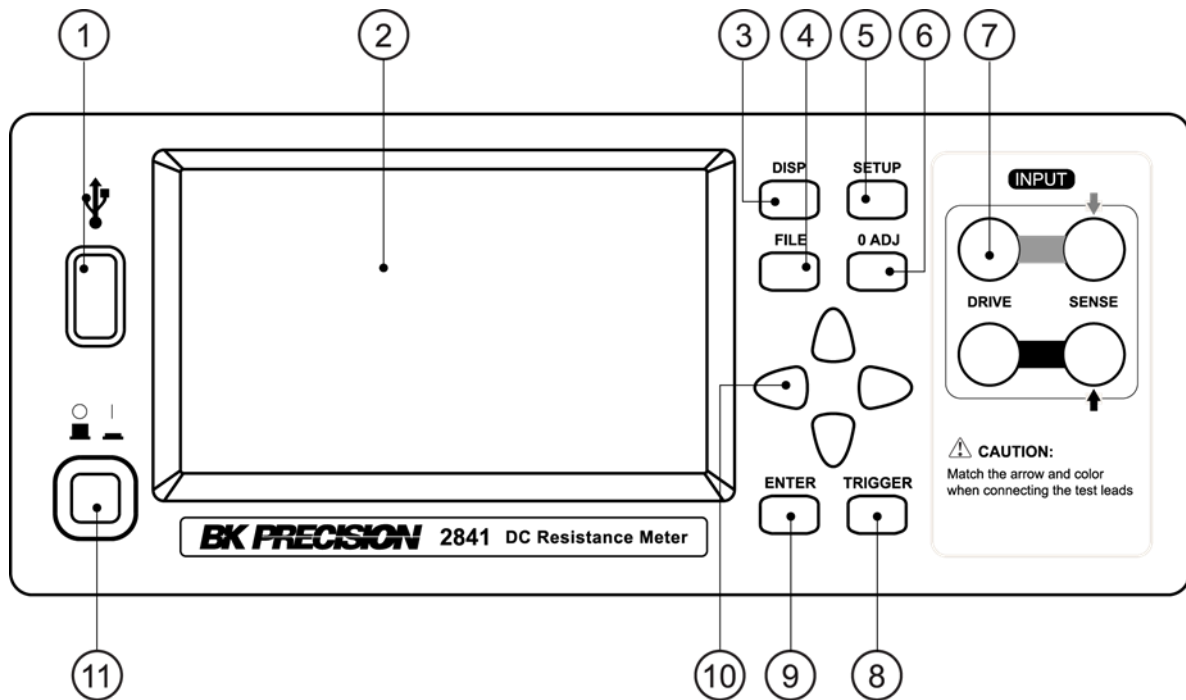

Figure 35 - Front Panel

Front Panel Description

①	USB Interface
②	LCD Touchscreen
③	DISP
④	FILE
⑤	SETUP
⑥	0 ADJ
⑦	Test Terminals
⑧	TRIGGER
⑨	ENTER
⑩	Universal Arrow Keys
⑪	Power

1.5 Rear Panel Overview

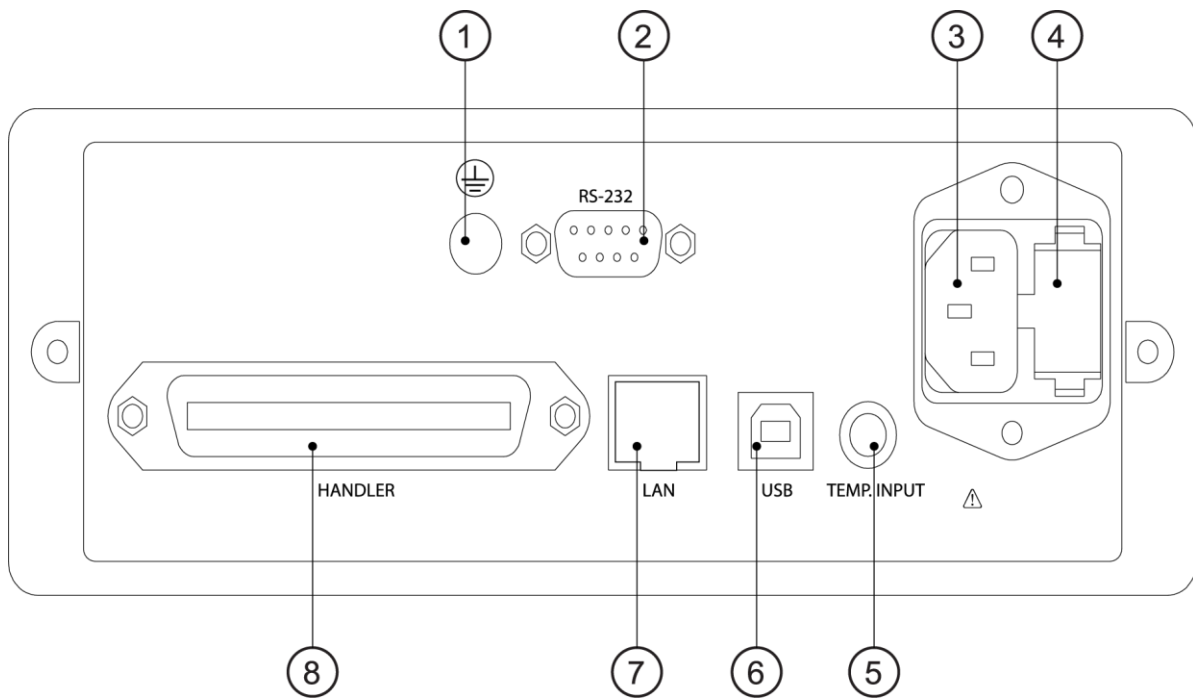

Figure 36 - Rear Panel

Rear Panel Description

-
- ① Ground Terminal

 - ② RS-232 Serial Interface

 - ③ Power Socket

 - ④ Fuse Socket

 - ⑤ Temperature input

 - ⑥ USB Interface

 - ⑦ LAN Interface

 - ⑧ Handler Interface

1.6 Keypad Overview

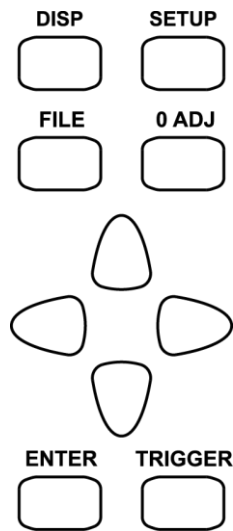





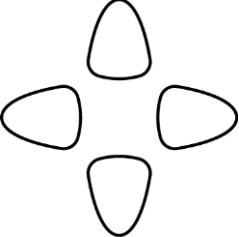

Figure 37 - Keypad

Keypad Description

	<p>DISP key Enters the main measurement display and opens display options</p>
	<p>SETUP key Enters the setup menu.</p>
	<p>FILE key Enters the internal and external file manager</p>
	<p>0 ADJ key Executes zero adjustment function</p>
	<p>TRIGGER key Manual trigger when trigger mode is set to MANU (manual)</p>
	<p>ENTER key Confirms setting</p>
	<p>Universal Arrow Keys Used to navigate any menu</p>

1.7 Display Overview

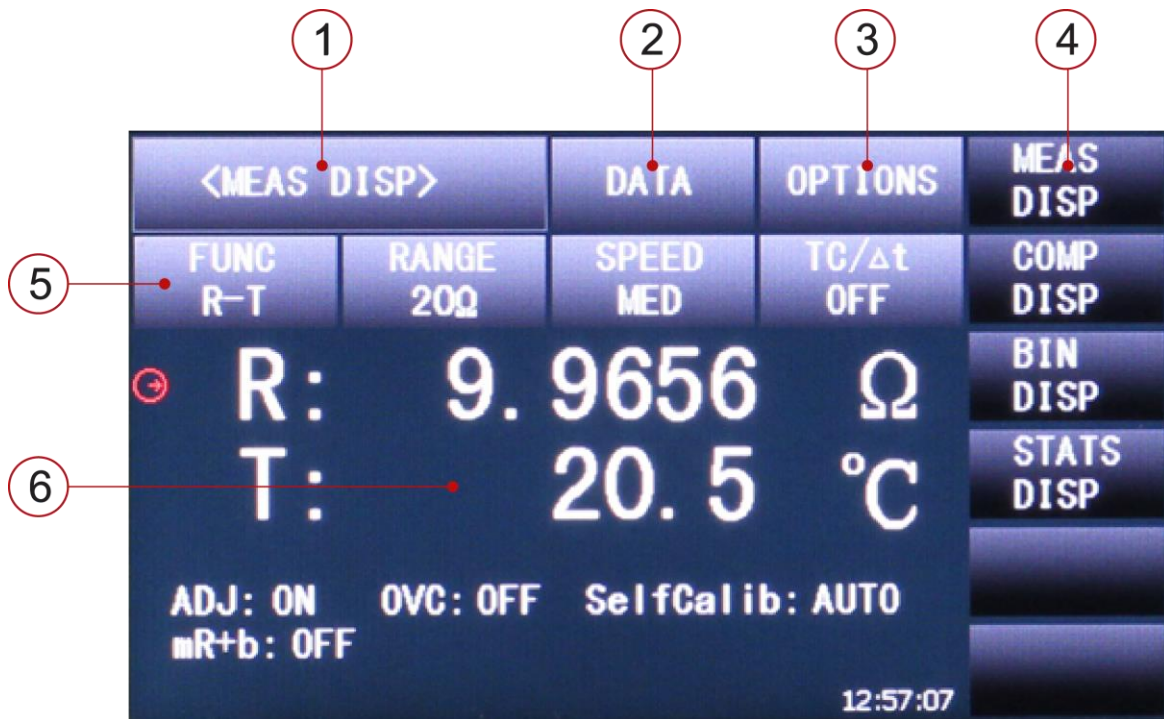

Figure 38 - Display

Display Description

- | | |
|---|---|
| ① | Display Name - Shows the current display name |
| ② | DATA – Access to save screen and file management (internal or external) |
| ③ | OPTIONS – Access to additional display specific functions |
| ④ | MENU OPTIONS – Displays the function menu depending on cursor location |
| ⑤ | FUNCTION – Access to measurement options |
| ⑥ | RESULTS DISPLAY – Shows values of ongoing measurement |

2 Getting Started

Before connecting and powering up the instrument, please review and go through the instructions in this chapter.

2.1 Input Power Requirements

The supply has a universal AC input that accepts line voltage input within:

Voltage: 110 V – 240 V ($\pm 10\%$)

Frequency: 50 Hz – 60 Hz ($\pm 5\%$)

Power supply power range: $\leq 30VA$

- The instrument has 50 and 60 Hz user selectable line filter in . Select 50 Hz or 60 Hz to match the line frequency. If the input power line has excessive noise, additional external noise filtering may be required.
- Before connecting to an AC outlet or external power source, make sure that the power switch is in the OFF position and verify that the AC power cord, including the extension line, is compatible with the rated voltage/current and that there is sufficient circuit capacity for the power supply. Once verified, connect the cable firmly.

⚠ WARNING

The included AC power cord is safety certified for this instrument operating in rated range. To change a cable or add an extension cable, be sure that it can meet the required power ratings for this instrument. Any misuse with wrong or unsafe cables will void the warranty.

2.2 Fuse Requirements

An AC input fuse is necessary when powering the instrument. The fuse is located at the back of the instrument. In the event the fuse needs to be replaced, make sure the AC input power cord is disconnected from the instrument before replacing. The below table shows the fuse required for all specified AC input voltages.

Before replacing fuse, disconnect AC input power cord first to prevent electric shock.

⚠ WARNING

Only use a fuse of the same rating as required. Using a different rated fuse will damage the instrument.

Fuse Specification
T1AL 250V

Table 9 - Fuse Specification

Check and/or Change Fuse

1. Locate the fuse box next to the AC input connector in the rear panel (see Figure 3 - Rear Panel)
2. With a small flat blade screwdriver, insert into the fuse box slit to pull and slide out the fuse box as indicated below.
3. Check and replace fuse (if necessary).

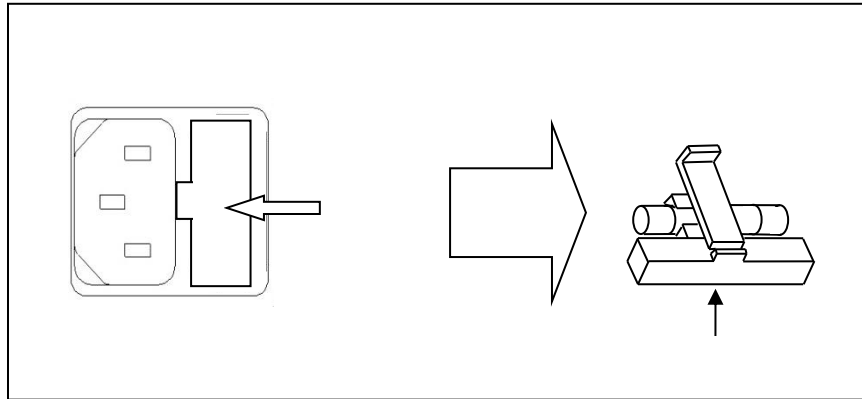

Figure 39 - Replacing Fuse



Any disassembling of the case or changing the fuse not performed by an authorized service technician will void the warranty of the instrument.

2.3 Input Connections

The instrument uses 4-terminal Kelvin test clips to measure more accurately and attain a higher level of performance than 2-terminal clips. Connect the cable to HI and LO terminals on the instrument front panel. Check the color and alignment arrows conformity of the test fixture with that of the connectors (see **Figure 8**). Do not insert the connectors vertically as this will cause inaccurate measurements (see **Figure 9**).

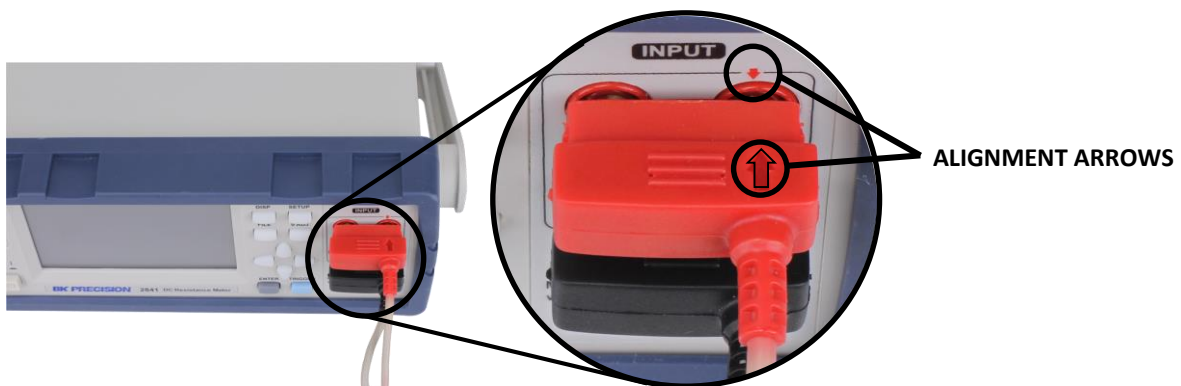

Figure 40 Connection Alignment



Figure 41 Do Not Connect Vertically

2.4 Preliminary Check

Complete the following steps to verify that the instrument is ready for use.

1. Verify AC Input Voltage

Verify and check to make sure proper AC voltages are available to power the instrument. The AC voltage range must meet the acceptable specification as explained in Input Power Requirements.

2. Connect Power

Connect AC power cord to the AC receptacle in the rear panel and press the power switch to the | () ON position to turn ON the instrument. The instrument will have a boot screen while loading (see **Figure 10**), after which the main screen will be displayed.

After power on, the loading screen will be displayed for about five seconds. The firmware version is found on the loading screen:

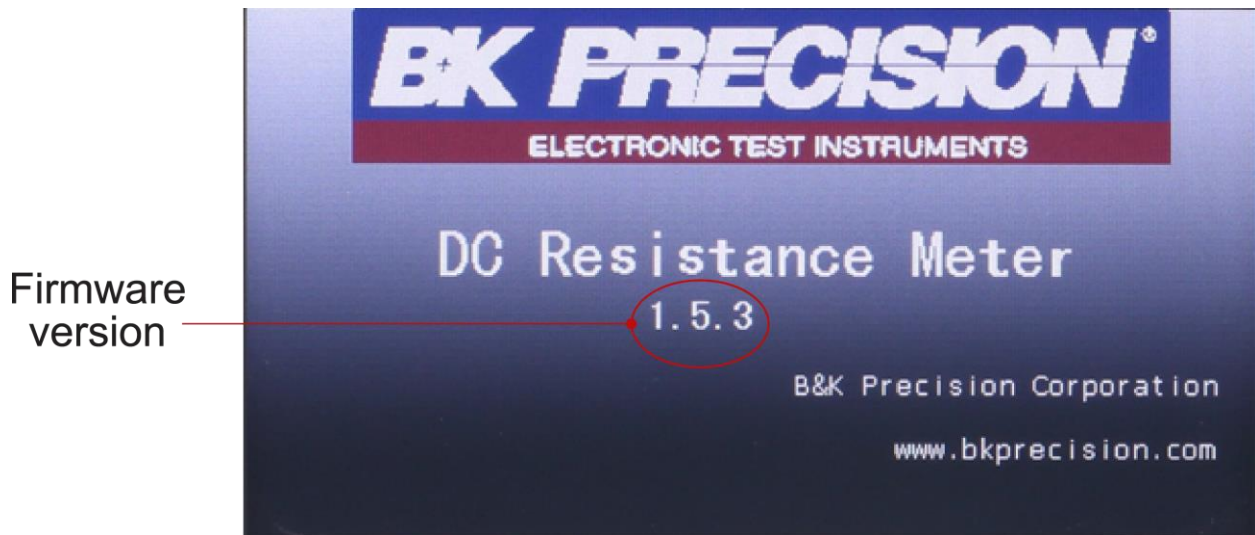

Figure 42 - Boot Screen

If password protection is enabled, the user will have to input the password to operate the unit. The default password is **2841** See **4.3.4 Password** for more details.

2.5 Cable Calibration

The resistance in the 4-terminal cables can be compensated for through the zero adjustment (0 ADJ) function. This should be performed when connecting a new cable to the instrument, when the environment temperature changes ± 5 °C, or when desired.

Complete the following steps to perform the cable calibration:

1. Warm-up the instrument for 30 minutes.
2. Short the 4-terminal connectors together (see **Figure 11**).
3. Ensure **DRIVE+** is aligned with **DRIVE-** and **SENSE+** is aligned with **SENSE-**.
4. Select a resistance range or AUTO to calibrate for all ranges.
5. Initiate the calibration function. Press **0 ADJ** on the front panel.
6. Calibration time is affected by the SPEED, AVERAGE samples, and auto ranging.

Note: If step 3 is not performed, zero adjustment will fail at the 20 m Ω and AUTO range.

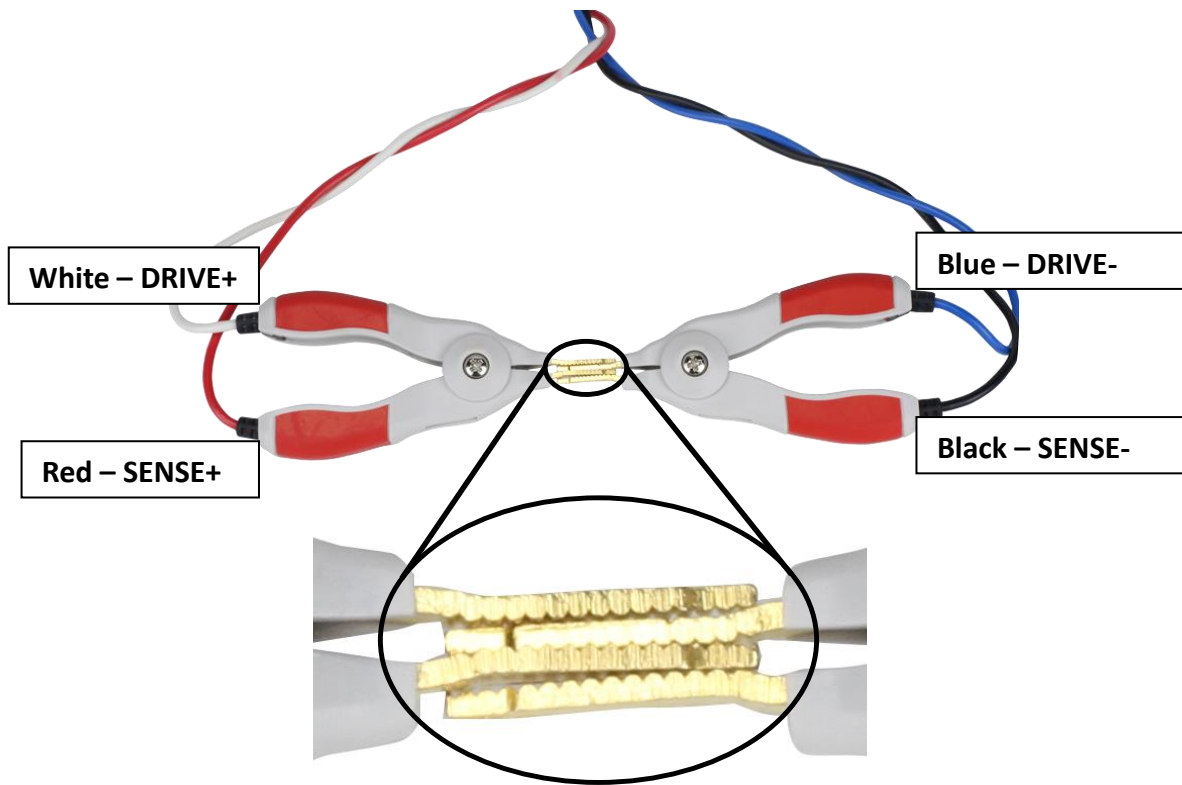

Figure 43 Short Connection

3 Front Panel Operation

The touchscreen menu displays contains all measurement and function options. The universal arrow keys along with the **ENTER** key can also be used to navigate the touchscreen. The measurement display menu consists of a primary menu and a secondary menu shown to the right of the screen.

There are 4 measurement operation displays:

1. Measurement Display
2. Comparator Display
3. Bin Display
4. Statistics Display

Each display and setup page has a **DATA** option for quick access to the file manager and save screen function. See **5 FILE MANAGER** for details.

When prompted to enter a numeric value, the numeric keypad will be displayed. Press **Enter** to confirm the value or **u**, **m**, **k** or **M** to confirm the value with the corresponding magnitude.

u = 10^{-6} ; **m** = 10^{-3} ; **k** = 10^3 ; **M** = 10^6

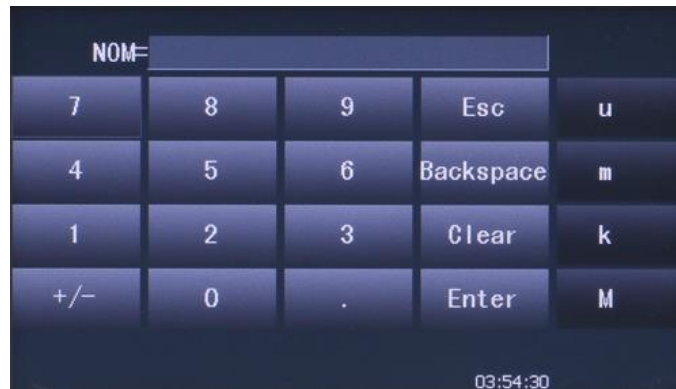

Figure 44 Numeric Keypad

When prompted to enter an alphanumeric value, the alphanumeric keypad will be displayed.

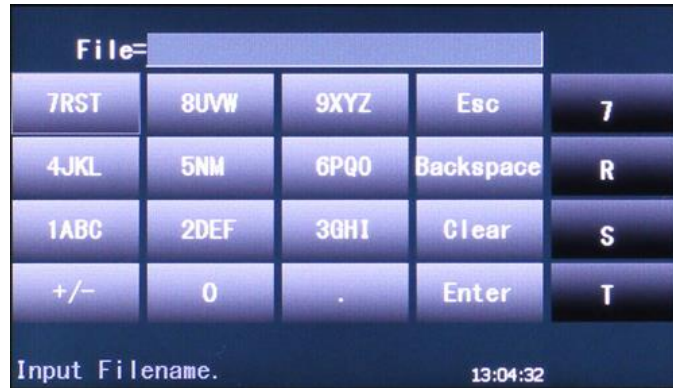

Figure 45 Alphanumeric Keypad

3.1 Measurement Display

The Measurement Display (MEAS DISP) is the main page for displaying resistance and temperature measurements. See 1.1 for additional options. To access the page press the **DISP** button and select **MEAS DISP** in menu options.

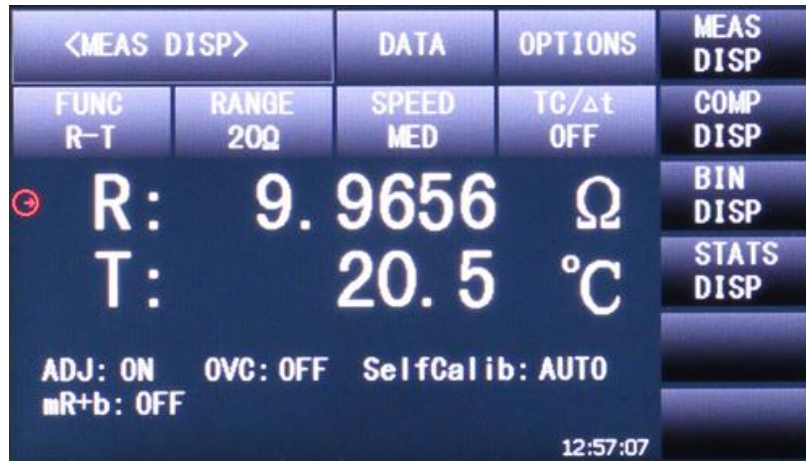

Figure 46 - Measurement Display

Touch the measurement result area to zoom the display, removing the menu options from the display. Touch again to return to the normal screen display.



Figure 47 Zoom Display

The following parameters are accessible from the Measurement Display.

OPTIONS	FUNC	RANGE	SPEED	TC/ Δt
<ul style="list-style-type: none"> •DISP •0 ADJ Compensation •0 ADJ •OVC •SELF CAL •SAVE DATA 	<ul style="list-style-type: none"> •R •R-T •T •LPR •LPR-T 	<ul style="list-style-type: none"> •AUTO •HOLD •↑ •↓ 	<ul style="list-style-type: none"> •FAST •MED •SLOW1 •SLOW2 	<ul style="list-style-type: none"> •TC •Δt

3.1.1 OPTIONS

The **OPTIONS** key allows the user to access the additional measurement options menu.

The measurement options are:

- **DISP (ON/OFF)**: Toggle the measurement results display on and off
- **0 ADJ (ON/OFF)**: Toggle the zero adjustment offset. OFF will not include the offset in the measurement calculation.
 - Example: If 0 ADJ offset = 0.1 m Ω in the 20 m Ω range, measured value = 5 m Ω
 - 0 ADJ ON: 4.9000 m Ω will be displayed
 - 0 ADJ OFF: 5.0000 m Ω will be displayed
- **0 ADJ**: Execute zero adjustment. See **2.5** for more details.
- Cable Calibration.

- **OVC (ON/OFF)**: Toggle Offset Voltage Compensation on and off. OVC increases accuracy at the cost of increased measurement time.

Note: OVC - When two different materials come into contact, a thermo electromotive force (EMF) will be generated on the contact surface and will vary with the ambient temperature. The higher the ambient temperature is, the larger the thermo electromotive force will be. The principle of OVC is to apply an inverse current through the test terminals and the formula is $R = \frac{R_p - R_n}{2}$, where R_p is a positive value, R_n is a negative value.

- **SELF CAL (AUTO/MANU)**: Toggle between auto and manual. See **4.1.7 0 ADJ** for details.
- **SAVE DATA**: Enabled when a USB flash drive is attached. When activated, resistance and temperature data is continuously saved to an auto-generated CSV onto the drive. The key changes to **STOP SAVE** to terminate the function. **SAVE DATA** is disabled if no USB flash drive is attached.

NOTICE

Removing the USB flash drive before pressing STOP SAVE will result in the loss of the recorded data. The CSV is rewritten every time.

3.1.2 FUNC

The **FUNC** key allows the user to measure resistance in normal or low voltage modes and display temperature.

The measurement modes are:

- **R**: Resistance
- **R-T**: Resistance and Temperature
- **T**: Temperature
- **LPR**: Resistance tested at low voltage
- **LPR-T**: Resistance tested at low voltage and temperature

3.1.3 RANGE

There are 2 resistance measurement modes:

6. Measurement Mode (R, R-T) with 11 ranges:

- 20 mΩ, 200 mΩ, 2 Ω, 20 Ω, 200 Ω, 2 kΩ, 20 kΩ, 100 kΩ, 1 MΩ, 10 MΩ, 100 MΩ

7. Measurement Mode at Low Voltage (LPR, LPR-T) with 4 ranges:

- 2 Ω, 20 Ω, 200 Ω, 2 kΩ

Follow the instructions below to set the resistance measurement ranges.

1. Touch the **RANGE** key, the following menu options will be displayed:

- **AUTO**: Automatically selects the range mode depending on the resistance detected.
- **HOLD**: Lock to the current resistance measurement range.
- **↑ (+)**: Increase measurement range and sets the measurement to **HOLD**.
- **↓ (-)**: Decrease measurement range and sets the measurement to **HOLD**.

If **FUNC** is set to **T**, resistance **RANGE** menu options are disabled and will display **AUTO**.

The temperature measurement (T) range is fixed at -10°C to 99.9°C.

3.1.4 SPEED

The **SPEED** controls the measurement time. In **SLOW1** and **SLOW2** mode noise is lower but measurement time is increased. **FAST** mode performs high speed measurements but with increased noise. See **1.1** for timing details.

Follow the instructions below to set the measurement speed.

1. Touch the **SPEED** key, the following menu options will be displayed:
 - **FAST**
 - **MED**
 - **SLOW1**
 - **SLOW2**

Note: In SLOW2, SLOW1 or MED mode, the resolution of the measurement is 6 digits. FAST mode is 5 digits.

3.1.5 TC/Δt

The **TC/Δt** option allows the user to enable the temperature compensation functions. Touch the **TC/Δt** key, the following menu options will be displayed:

- **OFF**: Disable all temperature compensation functions
- **TC**: Enable Temperature Correction. See **4.2.4** for details.
- **Δt**: Enable Temperature Conversion. See **4.2.5** for details.

3.2 Comparator Display

The Comparator Display (COMP DISP) page compares the resistance measurement to absolute limits or a nominal value \pm a percentage. The total count (TOT) is incremented and the result is categorized as high (HI), low (LO), or in (IN). To access the page press the **DISP** button and select **COMP DISP** in menu options.



Figure 48 - Comparator Display

Touch the measurement result area to enlarge display, removing the menu options from the display.



Figure 49 Comparator Display Enlarged

The following parameters are accessible from the Comparator Display.

OPTIONS	COMP	COMP MODE
<ul style="list-style-type: none">• DISP• COMP BEEP• COUNT• COUNT CLEAR• SAVE DATA	<ul style="list-style-type: none">• OFF• ON	<ul style="list-style-type: none">• %• NOM• %• ABS• HIGH• LOW

3.2.1 OPTIONS

The **OPTIONS** key allows the user to access the additional comparator option menu.

The options are:

- **DISP (ON/OFF)**: Toggle the measurement results display on and off
- **COMP BEEP (OFF/NG/GD)**: Toggles beep between off, not good (NG) and good (GD).
- **COUNT (ON/OFF)**: ON begins the comparator count if **COMP** is **ON**. Count increments based on trigger settings. OFF stops the count.
- **COUNT CLEAR**: HI, LO, IN, and TOT counts are reset to 0.
- **SAVE DATA**: Enabled when a USB flash drive is attached. When activated, resistance and temperature data is continuously saved to an auto-generated CSV onto the drive. The key changes to **STOP SAVE** to terminate the function. **SAVE DATA** is disabled if no USB flash drive attached.

NOTICE

Removing the USB flash drive before pressing STOP SAVE will result in the loss of the recorded data. The CSV is rewritten every time.

3.2.2 COMP

The **COMP** key turns the comparator functions **ON** and **OFF**. Results are in the results display area. COMP: NC will be displayed if **COMP** is **OFF**.

3.2.3 COMP MODE

The **COMP MODE** key allows the user to access two comparator modes.

- **% (Percent Error)**: The user can set the nominal value (**NOM**) and the percent error (**%**). If the nominal value is 100 and percentage is 10, the tolerance will be $100 \pm 10\%$. The instrument will compare the measured value to the tolerance and determine if the DUT is HI (above tolerance), LO (below tolerance), or IN (within tolerance). The display will show \pm percent (Δ) difference the measurement is from the nominal value.

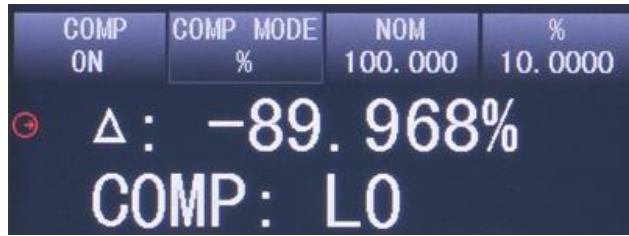

Figure 50 Comparator Display Percent Error

- **ABS (Absolute):** The user can set absolute **HIGH** and **LOW** limits. The instrument will compare the measured value to the absolute limits and determine if the DUT is HI (above the upper limit), LO (below the lower limit), or IN (within limits).

3.3 Bin Display

The Bin Display (BIN DISP) page places the resistance measurement in up to 10 user-defined bins. See **0** for instructions to define bins. The bin operation is executed when the instrument is triggered. To access the page press the **DISP** button and select **BIN DISP** in menu options.



Figure 51 - Bin Display

When the measurement is outside of a bin's tolerance, it is defined as **NOT GOOD (NG)**. When the measurement is inside of a bin's tolerance, it is defined as **GOOD (GD)**.

The following parameters are accessible from the Bin Display.

OPTIONS	BIN	BIN BEEP	NG COLOR	GD COLOR
<ul style="list-style-type: none">• DISP• SAVE DATA	<ul style="list-style-type: none">• OFF• ON	<ul style="list-style-type: none">• OFF• NG• GD	<ul style="list-style-type: none">• OFF• GRAY• RED• GREEN	<ul style="list-style-type: none">• OFF• GRAY• RED• GREEN

3.3.1 OPTIONS

The **OPTIONS** key allows the user to access the additional bin options menu.

The options are:

- **DISP (ON/OFF)**: Toggle the resistance measurement results display on and off
- **SAVE DATA**: Enabled when a USB flash drive is attached. When activated, resistance and temperature data is continuously saved to an auto-generated CSV onto the drive. The key changes to **STOP SAVE** to terminate the function. **SAVE DATA** is disabled if no USB flash drive attached.

NOTICE

Removing the USB flash drive before pressing **STOP SAVE** will result in the loss of the recorded data. The CSV is rewritten every time.

3.3.2 BIN

The **BIN** key turns the bin function and the bin results display on and off. Each bin is replaced with a horizontal line (—) when the function is off.

3.3.3 BIN BEEP

This option allows the user to select whether the unit will beep when a bin is determined. The user can select one of the following options:

- **OFF**: Turns off the bin beep function.
- **NG**: When the measurement result is different from the bin setting the beep will sound.
- **GD**: When the measurement result conforms to the bin setting the beep will sound.

3.3.4 NG COLOR & GD COLOR

The user can select what color will be displayed when the measurement is **NG** or **GD**. While the **NG COLOR** and **GD COLOR** settings can be set with the same color, it is recommended to use different colors to distinguish between a **NG** and **GD** measurement.

NG COLOR

- **OFF**: Nothing is displayed when the measurement result differs from the bin setting.
- **GREY**: When the measurement result differs from the bin setting, the corresponding bin will be displayed in grey.
- **RED**: When the measurement result differs from the bin setting, the corresponding bin will be displayed in red.
- **GREEN**: When the measurement result differs from the bin setting, the corresponding bin will be displayed in green.

GD COLOR

- **OFF**: Nothing is displayed when the measurement result is within the accepted values.
- **GREY**: When the measurement result conforms to the bin setting, the corresponding bin will be displayed in grey.
- **RED**: When the measurement result conforms to the bin setting, the corresponding bin will be displayed in red.
- **GREEN**: When the measurement result conforms to the bin setting, the corresponding bin will be displayed in green.

3.4 Statistics Display

The Statistics Display (STATS DISP) page calculates the statistical results of sampled measurements. Mean, standard deviation, min and max values among other statistical information are displayed. A sample is taken when the unit is triggered. To access the page press the **DISP** button and select **STATS DISP** in menu options.

<STATS DISP>		DATA	OPTIONS	CLEAR
EdgeMode ABS	Hi 11.0000	Lo 9.90000	Status ON	
MEAN 9.9657	STDEV 3.9062m	SaSTDEV 4.1760m	Cp 43.902	TRIG
CpK 5.242	Hi (num) 0	Lo (num) 0	In (num) 8	
Max 9.9658	MaxIndex 8	Min 9.9656	MinIndex 1	
R: 9.9657 Q num: 8 valn: 8 Statis is started.Trig!				SAVE DATA
				13:03:59

Figure 52 - Statistical Display

The following parameters are accessible from the Statistical Display.

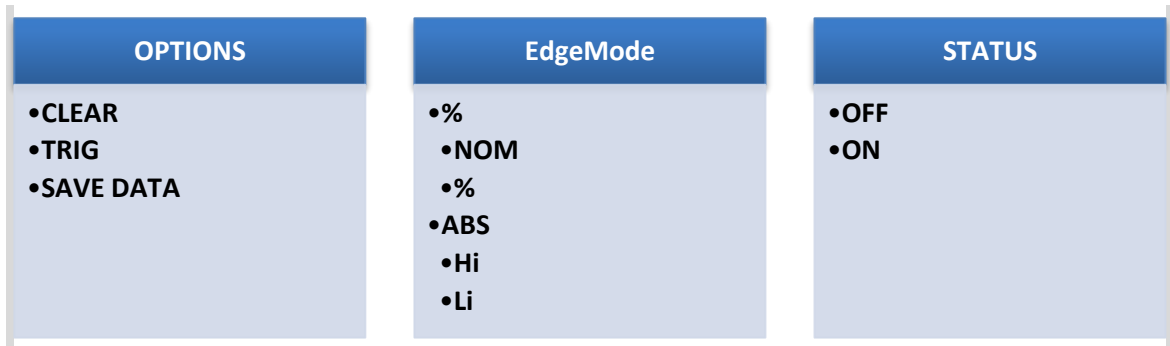

3.4.1 OPTIONS

The **OPTIONS** key allows the user to access the additional statistics options menu.

The measurement options are:

- **CLEAR:** Clear all statistical parameters.
- **TRIG:** Trigger measurement execution.
- **SAVE DATA:** Enabled when a USB flash drive is attached. When activated, resistance and temperature data is continuously saved to an auto-generated CSV onto the drive. The key changes to **STOP SAVE** to terminate the function. **SAVE DATA** is disabled if no USB flash drive attached.

NOTICE

Removing the USB flash drive before pressing **STOP SAVE** will result in the loss of the recorded data. The CSV is rewritten every time.

3.4.2 EdgeMode

The **EdgeMode** key allows the user to access two modes.

- **% (Percent Error):** The user can set the nominal value (**NOM**) and the percent error (**%**). If the nominal value is 100 and percentage is 10, the tolerance will be $100 \pm 10\%$. The instrument will compare the measured value to the tolerance and determine if the DUT is HI (above tolerance), LO (below tolerance), or IN (within tolerance).
- **ABS (Absolute):** The user can set absolute **HIGH** and **LOW** limits. The instrument will compare the measured values to the absolute limits and determine if the DUT is HI (above the upper limit), LO (below the lower limit), or IN (within limits).

3.4.3 Status

The **Status** key allows the user to turn the statistical calculations **OFF** and **ON**.

- **ON:** When ON is selected, all functions and buttons are disabled except the trigger and save screen functions. The instrument makes a statistical measurement at every trigger.

- **OFF**: When OFF is selected, the statistic measurements are disabled. All other functions and buttons are enabled.

3.4.4 Statistical Analysis Parameters

Parameter	Variable	Description	Formula
MEAN	\bar{x}	Average value	$\bar{x} = \frac{\sum x}{n}$
STDEV	σ	Population Standard Deviation	$\sigma = \sqrt{\frac{\sum(x - \bar{x})^2}{n}}$
SaSTDEV	σ_{n-1}	Sample Standard Deviation	$\sigma_{n-1} = \sqrt{\frac{\sum(x - \bar{x})^2}{n - 1}}$
Cp	C_p	Process Capability Index (Dispersion)	$C_p = \frac{ USL - LSL }{6\sigma_{n-1}}$
CpK	C_{pk}	Process Capability Index (Deviation)	$C_{pk} = \frac{ USL - LSL - USL + LSL - 2\bar{x} }{6\sigma_{n-1}}$

Table 10 Statistical Analysis Parameters

NOTE: Variables in Table 2 - Statistical Analysis Parameters formulas:

n: The total number of samples.

x: Measurement results of each sample measurement. The data are saved in the instrument buffer memory.

USL: Upper specification limit. If NOM, % is 100±10% then **USL**= 110.

LSL: Lower specification limit. If NOM, % is 100±10% then **LSL** = 90.

When **Cp, Cpk > 1.33**, the working capacity is ideal.

When **1.33 ≥ Cp, Cpk > 1.00**, the working capacity is sufficient.

When **1.00 ≥ Cp, Cpk**, the working capacity is insufficient.

- **Hi**: Incremented when the measurement result exceeds the upper limit value **USL**.
- **Lo**: Incremented when the measurement result is less than the lower limit value **LSL**.
- **In**: Incremented when the measurement result is within the limits.
- **Max**: Maximum measurement result among the current data set.
- **MaxIndex**: Sample index number that corresponds to the maximum measurement result.

- **Min:** Minimum measurement result among the current data set.
- **MinIndex:** Sample index number that corresponds to the minimum measurement result.

Example:

NOM, % is 100±10%

Sample Index	1	2	3	4	5	6	8
Result (Ω)	100.4	101.6	103.7	98.4	87.9	112.1	86.5

Results:

Hi = 1, Lo = 2, In = 5, Max = 112.1, MaxIndex = 6, Min = 86.5, MinIndex = 8

4 Setup Menus

The setup menus allow the user to have more control the measurement operations, functions, and calculations. The universal arrow keys along with the **ENTER** key can also be used to navigate the touchscreen. The setup page menus consists of a primary menu and a secondary menu shown to the right of the screen.

There are 5 setup pages:

5. Measurement Setup
6. Temperature Compensation (TC/ Δt) Setup
7. Bin Setup
8. System Setup
9. LAN Setup

4.1 Measurement Setup

The Measurement Setup (**MEAS SETUP**) page has additional measurement parameters. To access the page press the **SETUP** button and select **MEAS SETUP** in menu options. <MEAS SETUP> is the default setup page.

<MEAS SETUP>	DATA	mR+b OFF	MEAS SETUP
FUNC R-T	RANGE 20Ω	TRIG INT	TC/ Δt SETUP
TRIG DELAY AUTO	AVERAGE 1	200mΩ 100mA	BIN SETUP
DETECT AUTO	Meas Mode SLOW	SPEED MED	SYSTEM SETUP
m 1.000	b 0.000	Adjust AUTO	LAN SETUP

04:00:12

Figure 53 - Measurement Setup

The following parameters are accessible from the Measurement Setup page:

mR+b	FUNC	RANGE	TRIG	TRIG DELAY	AVERAGE
<ul style="list-style-type: none"> •OFF •ON 	<ul style="list-style-type: none"> •R •R-T •T •LPR •LPR-T 	<ul style="list-style-type: none"> •AUTO •HOLD •↑ •↓ 	<ul style="list-style-type: none"> •INT •MAN •EXT •BUS 	<ul style="list-style-type: none"> •AUTO •MANU •INPUT 	<ul style="list-style-type: none"> •1 - 255

200 mΩ	DETECT	Meas Mode	SPEED	m	b	Adjust
<ul style="list-style-type: none"> •1A •100mA 	<ul style="list-style-type: none"> •AUTO •MANU •INPUT 	<ul style="list-style-type: none"> •SLOW •FAST 	<ul style="list-style-type: none"> •FASST •MED •SLOW1 •SLOW2 	<ul style="list-style-type: none"> •-1000000 to 1000000 	<ul style="list-style-type: none"> •-1000000 to 1000000 	<ul style="list-style-type: none"> •AUTO •MANU

4.1.1 mR + b

This algebraic function displays a modified result to the resistance measurement display. The function can be selected **ON** or **OFF**. The variables **m** and **b** open a numeric keypad to enter a value.

Example calculation: R (measurement) = 10.0404 Ω; $m = 2$; $b = 5$

$$m * R + b = 2 * 10.0404 \Omega + 5 = 25.0808 \Omega$$

25.0808 Ω will be displayed in the measurement result area instead of 10.0404 Ω.

4.1.2 FUNC

This function is identical to **FUNC** on **<MEAS DISP>** page. See **3.1.2** for details.

4.1.3 RANGE

This function is identical to **RANGE** on **<MEAS DISP>** page. See **3.1.3** for details.

4.1.4 TRIG

Press **TRIG** to access the 4 trigger mode options:

- **INT**: Continuously test a DUT and display the result.
- **MAN**: Press **TRIGGER** to test a DUT once and display the result.
- **EXT**: Trigger the instrument through the $\overline{\text{TRIG}}$ handler pin 4.
- **BUS**: Trigger the instrument through the COM interface.

Note: The instrument is in waiting mode until triggered.

4.1.5 TRIG DELAY

The **TRIG DELAY** enables the user to select between **AUTO** and **MANU** (manual) modes. Automatic trigger delay is determined by **Table 11 Auto Trigger Delay**. To set a manual trigger delay:

1. Press **MANU**
2. Press **INPUT** for open a numeric keypad.
3. Set delay. Manual trigger delay range is: 0 ms to 9999 ms.

Note: TRIG DELAY cannot be less than the DETECT time. The instrument will prompt a message “Data out of range.”

	Range(Ω)	20m	200m	2	20	200	2k	20k	100k	1M	10M	100M
Resistance Measurement Delay (ms)	OVC OFF	30	30	3	3	3	3	3	10	50	100	1000
	OVC ON	100	100	100	100	100	100	100	—	—	—	—
Resistance Measurement at low voltage Delay(ms)	OVC OFF	—	—	3	3	3	15	—	—	—	—	—
	OVC ON	—	—	100	100	100	100	—	—	—	—	—

Table 11 Auto Trigger Delay

Note: If delay time is set to 0 ms, the contact settling time detection cannot be executed. It is recommended to set the delay time to be greater than 1 ms.

4.1.6 AVERAGE

Press **AVERAGE** to open a numeric keypad. The user can set the average number a samples taken per trigger, ranging from 1 to 255. The larger the sample sizes reduces variation at the cost of a longer time to display the result.

4.1.7 200m Ω

The 200 m Ω resistance measurement range has two current source options.

- **1A**: Open voltage is 5 V max.
- **100mA**: Open voltage is 2.6 V max.

4.1.8 DETECT

DUT detection is the time between trigger initiation and when the measurement starts. The user can select from the following options:

- **AUTO**: Internally set timing.

- **MANU**: Detection time manually set.
- **INPUT**: Opens numeric keypad to modify manual detection timing.

4.1.9 Meas Mode

The instrument has an internal 10 nF capacitor that can be connected or disconnected across the terminals. Commonly used when measuring large resistors and inductors. The user can select between the following modes:

- **SLOW**: Connects the 10 nF capacitor across the test terminals.
- **FAST**: Disconnects the 10 nF capacitor across the test terminals.

4.1.10 Adjust

Internal instrument corrections are controlled by **Adjust**. These corrections take 55ms. The user can select between the following modes:

- **AUTO**: Enable the instrument to automatically make corrections every 30 minutes.
- **MANU**: Corrections occur only when manually triggered by $\overline{\text{CAL}}$ handler pin 29.

4.2 Temperature Compensation (TC/ Δt) Setup

The **TC/ Δt SETUP** page is where the user can enable the temperature compensation functions, modify temperature calculation parameters, and select the temperature probe type. The connector is a ¼ inch shielded jack. To access the page press the **SETUP** button and select **TC/ Δt SETUP** in menu options.



<TC/ Δt SETUP>		DATA	
t0 (°C)	αt_0 (ppm)	R1 (Ω)	
0.0	3390	100.000	
t1 (°C)	k ()	V1 (V)	
23.0	235.0	0.00	
T1 (°C)	V2 (V)	T2 (°C)	
0.0	2.00	100.0	
TC/ Δt	T. SENS		
OFF	Pt		
			12:59:35

Figure 54 - TC/ Δt setup

The following parameters are accessible from the Temperature Compensation Setup page:

TC	Δt	Analog	TC/ Δt	T.SENS
<ul style="list-style-type: none"> • t0 (°C) • $\alpha t0$ (ppm) 	<ul style="list-style-type: none"> • R1 (Ω) • t1 (°C) • k 	<ul style="list-style-type: none"> • V1 (V) • V2 (V) • T1 (°C) • T2 (°C) 	<ul style="list-style-type: none"> • OFF • TC • Δt 	<ul style="list-style-type: none"> • Pt • AnLG_In

Note:

1. The temperature probe detects ambient temperature, not DUT surface temperature.
2. Before measurement, warm up the instrument and probe for about half an hour.
3. The temperature probe should be placed as close as possible to the DUT but not in direct contact.

4.2.1 Parameter Settings

Each parameter key opens a numeric keypad to input the corresponding value.

Temperature Correction (TC) Parameters:

- **t0** (°C): Reference temperature.
- **$\alpha t0$** (ppm): DUT temperature coefficient of DUT at t0.

Temperature Conversion (Δt) Parameters:

- **R1** (Ω): Resistance at the start of the thermal test
- **t1** (°C): DUT temperature at the start of the thermal test
- **k**: Reciprocal of the DUT temperature coefficient at 0 °C

Analog Input Parameters:

- **V1** (V): Reference voltage 1
- **V2** (V): Reference voltage 2
- **T1** (°C): Reference temperature 1
- **T2** (°C): Reference temperature 2

4.2.2 TC/ Δt

The **TC/ Δt** option allows the user to enable the temperature compensation functions. Touch the **TC/ Δt** key, the following menu options will be displayed:

- **OFF**: Disable all temperature compensation functions
- **TC**: Enable Temperature Correction. See below for details.
- **Δt** : Enable Temperature Conversion. See below for details.

4.2.3 Types of Temperature Sensors

The instrument is designed to use two types of temperature input: Pt and Analog Input. Touch the **T.SENS** key, the following menu options will be displayed:

- **Pt**: Provided temperature probe.
- **AnLG_In**: Linearly converts probe input voltage (0 to 2 V) into temperature based on Analog Input settings. See **4.2.6 Analog Input**.

4.2.4 Temperature Correction (TC) Function

The resistance of a material changes with temperature according to the material's temperature coefficient. The temperature correction function compensates for changes in resistance due to changes in ambient temperature. The measured resistance is displayed as if it was measured at the preset temperature.

$$R_t = R_{t0} * \{ 1 - \alpha_{t0} * (t - t_0) \}$$

R_t - Resistance measured under the current ambient temperature

R_{t0} - Resistance corrected to the preset temperature

t_0 - Preset temperature

t - Current ambient temperature

α_{t0} - Temperature coefficient of the material

Example:

A copper DUT measured 10.393 Ω at 30 °C. Coppers temperature coefficient is 3930 ppm / °C at 20 °C.

$$R_{t0} = \frac{R_t}{1 + \alpha_{t0} * (t - t_0)} = \frac{10.393}{1 + (3930 \times 10^{-6}) * (30 - 20)} = 10.000 \Omega \text{ at } 20 \text{ }^\circ\text{C}$$

4.2.5 Temperature Conversion (Δt) Function

This function converts the change in a DUT's winding resistance into a change in temperature. The user measures the DUT's resistance and surface temperature before operation (cold) and measures the DUT's resistance and ambient temperature after the element has heated up (hot) from operation and is no longer powered. Δt represents an estimate of the DUT's change in temperature between the cold and hot state. This is typically used to measure a motor's temperature or the inside of a coil after heating up from operation and power is removed.

$$\Delta t = \frac{R_2}{R_1} (k + t_1) - (k + t_a)$$

Δt – Temperature difference between the initial cold and final hot state.

R_1 – Resistance at the start of the thermal test.

R_2 – Resistance at the end of the thermal test.

t_1 – DUT temperature at the start of the thermal test.

t_a – Ambient temperature at the end of the thermal test.

k – Variance ration of the temperature coefficient when the conductor is at 0 °C.

Example:

A copper DUT is measure before operation: R_1 is 100 mΩ, t_1 is 20 °C. A second measurement is taken after operation and power is removed: R_2 is 105 mΩ, t_a is 25 °C. k is 234.5.

The temperature change is calculated:

$$\Delta t = \frac{R_2}{R_1} (k + t_1) - (k + t_a) = \frac{105 \times 10^{-3}}{100 \times 10^{-3}} (234.5 + 20) - (234.5 + 25) = 7.725^\circ\text{C}$$

The DUT's temperature (t_R) can be estimated be adding the ambient and change in temperature.

$$t_R = t_a + \Delta t = 25 + 7.725 = 32.725^\circ\text{C}$$

The k constant can be calculated for a material with a temperature coefficient α_{t_0} at a given temperature t_0 with the following formula.

$$k = \frac{1}{\alpha_{t_0}} - t_0$$

The copper k constant can be calculated where $\alpha_{t_0} = 3930\text{ppm}$ at $t_0 = 20^\circ\text{C}$.

$$k = \frac{1}{\alpha_{t_0}} - t_0 = \frac{1}{3930 * 10^{-6}} - 20 = 234.5$$

4.2.6 Analog Input

Tap the **T.SENS** soft key to select the temperature input type. **AnLG_In** is analog input and the corresponding formal is:

$$\text{Measured Temperature} = \frac{T_2 - T_1}{V_2 - V_1} * \text{Input Voltage} + \frac{T_1 V_2 - T_2 V_1}{V_2 - V_1}$$

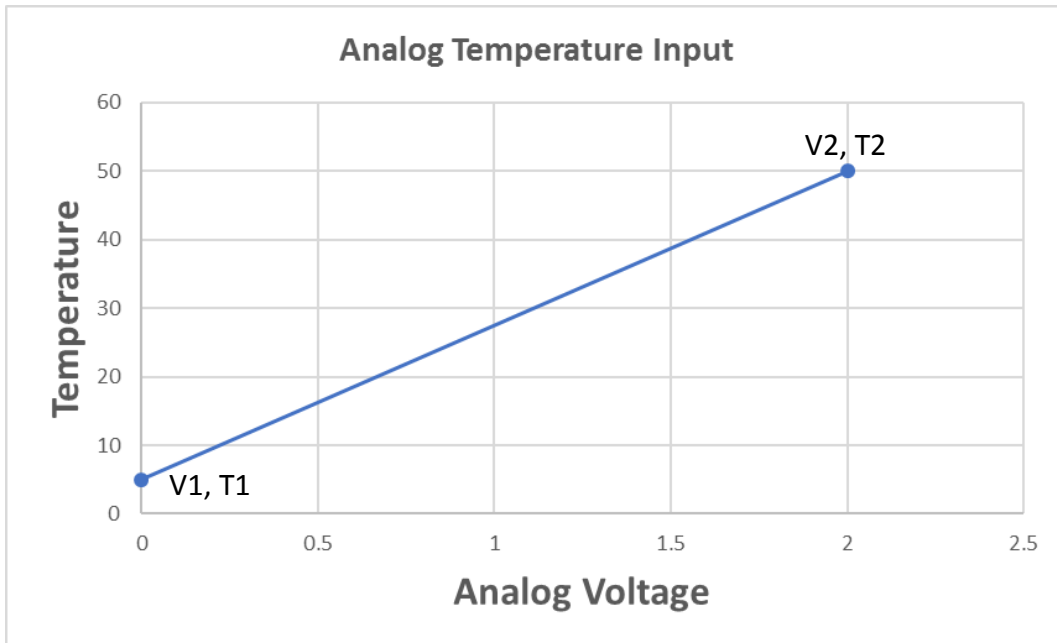

Figure 55 - Analog Input Voltage vs Temperature

Note: V1 and V2 range from 0.00V to 2.00V while T1 and T2 range from -99.9 °C to 999.9 °C.

4.3 BIN SETUP

The **BIN SETUP** page is where the user can define the parameters for up to 10 bins.

To access the page press the **SETUP** button and select **BIN SETUP** in menu options.

<BIN SETUP>		DATA	OPTIONS	MEAS SETUP
BIN NO.	STATE	HIGH	LOW	TC/ Δ t SETUP
0	ON	6.00000	5.00000	BIN SETUP
1	OFF			SYSTEM SETUP
2	OFF			LAN SETUP
				13:00:04

Figure 56 - Bin Setup

The following parameters are accessible from the Bin Setup page:

OPTIONS	BIN NO.	0 to 9	STATE
<ul style="list-style-type: none">• BIN MODE• BIN BEEP• BIN CLEAR• BIN OUT	<ul style="list-style-type: none">• PgUp• PgDn	<ul style="list-style-type: none">• DEL	<ul style="list-style-type: none">• OFF• ON

4.3.1 OPTIONS

The **OPTIONS** key allows the user to access the additional bin setup options menu.

The options are:

- **BIN MODE**: Toggle between **%** (percentage error) and **ABS** (Absolute limits).
- **BIN BEEP**: Toggle between three bin beep modes: **OFF**, **NG** and **GD**.
- **BIN CLEAR**: Clear all setting parameters for all bins.
- **BIN OUT**: Toggle between **BCD** (binary output) and **BIN** (bin compare result output) modes that format the handler interface output.

4.3.2 BIN NO.

Press **BIN NO.** to display **PgUp** and **PgDn** keys and navigate between bins 0 to 9.

4.3.3 BIN 0 to 9

Press the bin number **0** to **9** and display the **DEL** option. Press **DEL** to delete bin settings and set the state to **OFF**.

4.3.4 STATE

Press **STATE** to display the bin state as **ON** or **OFF**. When **ON** is set, the corresponding bin in the display zone will be shown as lighted circle. When **OFF** is set, the corresponding bin is shown as a horizontal line (—).

4.3.5 BIN MODE

The bin calculation is determined by the BIN MODE. Press the limit or value field to open a numeric keypad.

If **BIN MODE: ABS** is selected:

- **HIGH**: Input the high limit for DUT comparison.
- **LOW**: Input the low limit for DUT comparison.

If **BIN MODE: %** is selected:

- **NOM**: Input the nominal value.
- **%**: Input the percentage value.

4.4 SYSTEM SETUP

The **SYSTEM SETUP** page is where the user can change instrument settings. To access the page press the **SETUP** button and select **SYSTEM SETUP** in menu options.



Figure 57 - System Setup

The following parameters are accessible from the System Setup page:

OPTIONS <ul style="list-style-type: none"> • SYSTEM RESET • DEFAULT SETTINGS 	TouchTone <ul style="list-style-type: none"> • OFF • ON 	Language <ul style="list-style-type: none"> • ENGLISH • CHINESE 	Password <ul style="list-style-type: none"> • OFF • LOCK SYSTEM • LOCK FILE • MODIFY 	Bus Mode <ul style="list-style-type: none"> • RS232C • LAN • USBTMC • USBVCOM
Baud Rate <ul style="list-style-type: none"> • 9600 • 19200 • 28800 • 38400 • 96000 • 115200 	EOC(ms) <ul style="list-style-type: none"> • HOLD • PULSE • Input 	Err.OUT <ul style="list-style-type: none"> • ASYNC • SYNC 	AC Freq <ul style="list-style-type: none"> • 50Hz • 60Hz 	

4.4.1 OPTIONS

The **OPTIONS** key allows the user to access the additional system setup options menu.

The options are:

- **SYSTEM RESET**: Performs a soft reset on the instrument.
- **DEFAULT SETTINGS**: Restores default settings.

4.4.2 TouchTone

Press **TouchTone** to select the touch tone **ON** or **OFF**. When selected **ON**, the tone is played when a touch screen key is touched or a button is pressed. **OFF** disables the tone.

4.4.3 Language

Press **Language** to select the displayed language, **ENGLISH** or **CHINESE**. The default language is English.

4.4.4 Password

Press **Password** to access the following menu options:

- **OFF**: Touch this key to turn off the password protection function. This function requires the user to input the current password to activate.
- **LOCK SYSTEM**: Touch this key to enable the password function. Please input the password which will be required to be input when opening a file or starting up the instrument.
- **LOCK FILE**: It is necessary to input the password if this function is enabled.
- **MODIFY**: Touch this key to modify the password.

Steps for changing the password:

1. Touch **MODIFY** to open an alphanumeric keypad.
2. Input the original password and press **ENTER** to confirm.
3. Prompt: "Input password"
4. Input the new password and press **ENTER** to confirm.
5. Prompt: "New password"
6. Input the new password a second time and press **ENTER** to confirm.
7. Prompt: "Confirm new password"
8. The <SYSTEM SETUP> page will be displayed and the password modification is complete.
9. Prompt: "Password modify ok"

Note: The default password is 2841

4.4.5 Bus Mode

Press **Bus Mode** to select the communication interface in the menu options. All interfaces are accessible on the rear panel.

- **RS232C**
- **LAN**
- **USBTMC**
- **USBVCOM**

4.4.6 Baud Rate

Press **Baud Rate** to select from the following six baud rates:

- 9600
- 19200
- 28800
- 38400
- 57600
- 115200

4.4.7 EOC Signal

The **EOC** signal can be found on handler pin 12. The End of Conversion signal is pulled low at the beginning of measurement and pulled high at the end of all instruments internal calculations. **EOC** enables the user to select between **HOLD** and **PULSE** modes. **HOLD** will keep the **EOC** signal high, waiting for the next trigger. In **PULSE** mode the **EOC** signal pulse width is manually controlled. The user can manually set the with **PULSE** mode:

1. Press **PULSE**
2. Press **Input** for open a numeric keypad.
3. Set pulse width. Range: 0 ms – 100 ms.

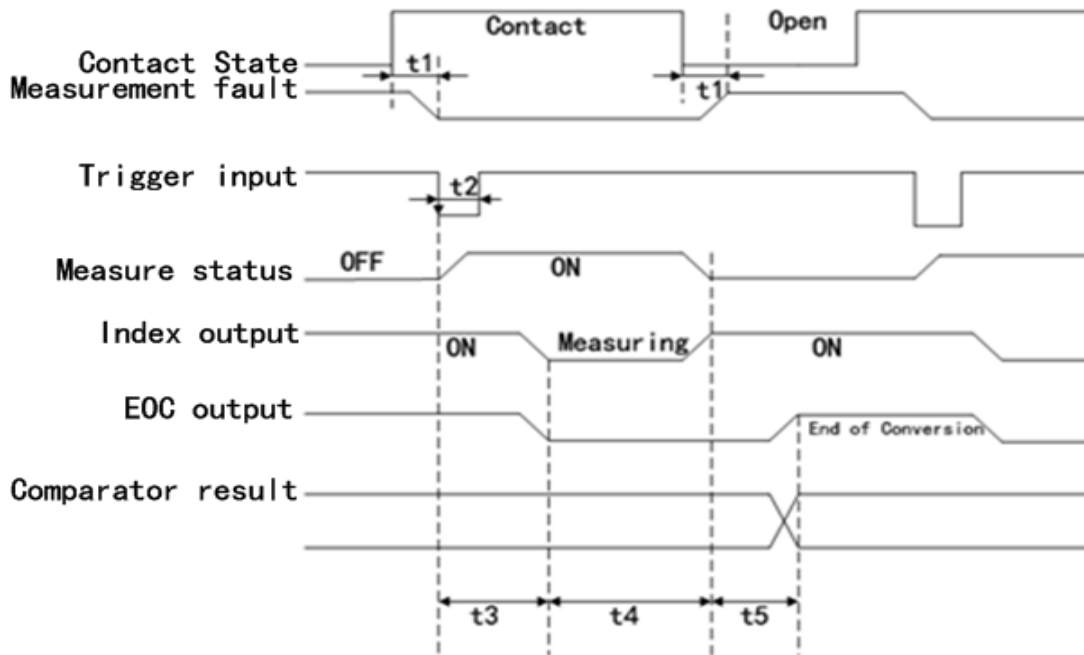

Figure 58 External Trigger Timing

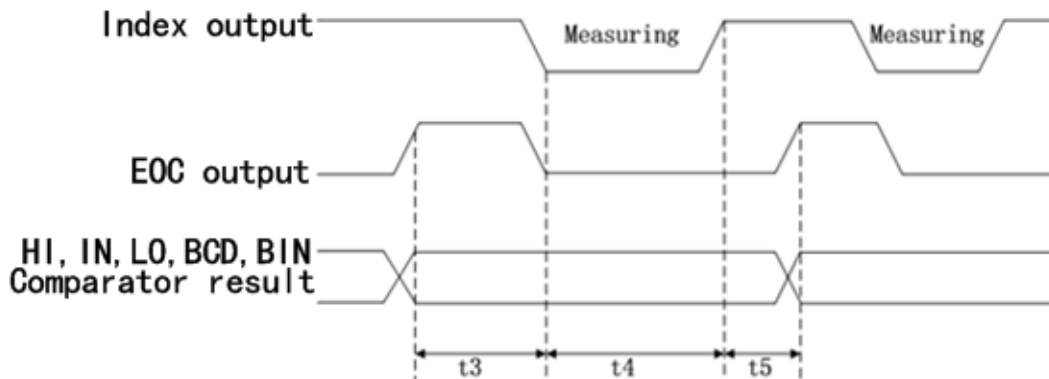
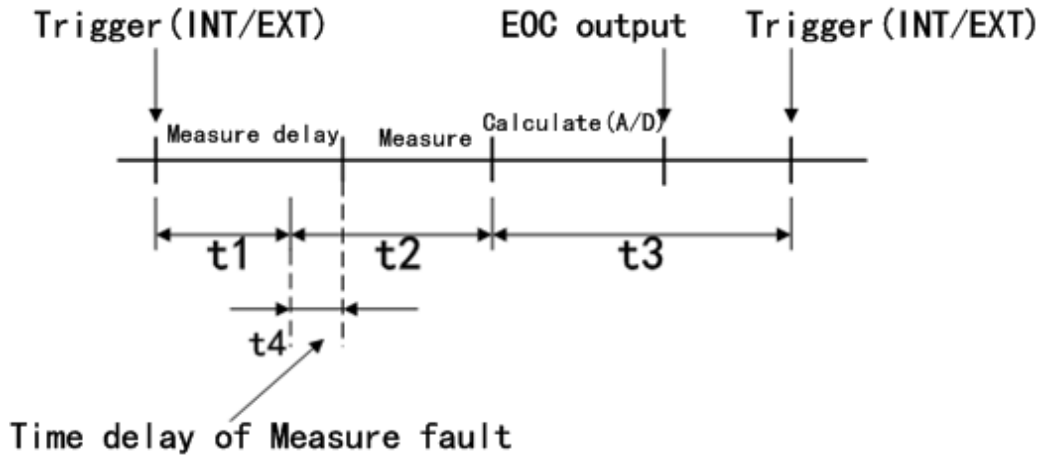

Figure 59 Internal Trigger Timing

4.4.8 Err.OUT signal

The **Err.OUT** signal can be found on pin 11 of the [Handler]. A measurement error occurs when the instrument has lost contact with a DUT. Press **Err.OUT** to select between:

- **SYNC**: If the measurement error is detected during t2, the instrument will output an error signal. No error detection will be taken in other time ranges.
- **ASYNC**: If the measurement error is detected during t2, the instrument will output a measurement error signal. If the measurement error is detected during t2 and t3 (time until next trigger) and lasts for over 5 ms, the instrument will output an error signal. If the measurement error disappears within 5 ms, no measurement error signal will be output.



AC Frequency

Press **AC Freq** to select the power supply frequency: **50Hz** or **60Hz**. Selecting the correct frequency reduces the power line noise's influence on the instrument.

4.4.9 Setting Time and Date

Touch the time or date digits to open the modification menu.

For example: 9 o'clock 13 minute and 25 second a.m. on November 12, 2010 will be shown as 10-11-12 09:13:25.

Operations are as follows: Touch the time zone to be modified, the following items will be displayed.

- **++**: Increment by 5.
- **+**: Increment by 1.
- **-**: Decrement by 1.
- **--**: Decrement by 5.
- **<<**: Cursor under the time date move left.
- **>>**: Cursor under the time date move right.

Bus Addr and **GPIB** is not supported.

4.5 LAN SETUP

The LAN SETUP page is where the user can setup the instrument up to connect over a Local Area Network (LAN). To access the page press the **SETUP** button and select **LAN SETUP** in menu

The screenshot shows the LAN SETUP screen with a numeric keypad. The keypad is used to input values for the following fields:

Field	1	0	1	60
IP ADDR	10	0	1	60
SUBNET MASK	255	255	254	0
GATEWAY	10	0	1	254
DNS SERVER1	10	0	1	254
DNS SERVER2	10	0	1	254

Additional elements on the screen include: a top bar with '<LAN SETUP>' and 'DATA'; a right-side menu with 'MEAS SETUP', 'TC/Δt SETUP', 'BIN SETUP', 'SYSTEM SETUP', and 'LAN SETUP'; and a digital clock at the bottom right showing '13:00:56'.

options.

Figure 60 LAN SETUP

The user can modify all addresses on the screen by touching the number zone and accessing the numeric keypad. The following addresses can be set:

- **IP ADDR**
- **SUBNET MASK**
- **GATEWAY**
- **DNS SERVER1**
- **DNS SERVER2**

Note: Bus Mode in SYSTEM SETUP must be set to LAN to enable network connection to the instrument.

5 FILE MANAGER

The file manager menu is used to save and load parameter configuration files (.STA) set by the user. These files can be saved to the internal (I) non-volatile memory or an external (E) USB flash drive. Insert an empty USB flash drive to the front panel USB port and wait for the drive to initialize (about five seconds).

To access the file manager menu:

1. Press the **FILE** button or select the **DATA** key that can be found on all display pages, then select **FILE**.
2. Press **<INTERNAL FILE>** or **<EXTERNAL FILE>** to navigate between screens.

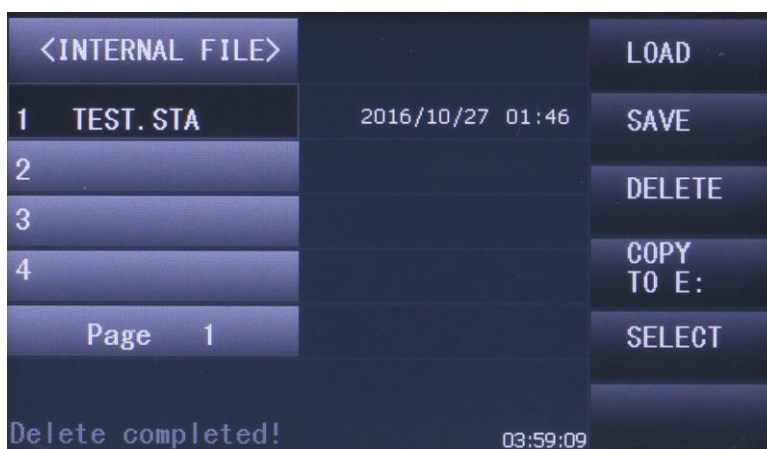

Figure 61 – File Manager

5.1 File Structure

The internal non-volatile memory can store up to 30 STA files. The following folder structure is automatically created on a USB flash drive when an external USB flash drive is connected.

Folder	Maximum Amount of File	Description
CSV	1	Measurement results, *.CSV file.
STA	40	Configuration data, *.STA file.
PIC	999	Screen capture, *.gif file.

Table 12 Folders Generated in USB

5.1.1 Saving Configuration Files

1. Navigate to the FILE MANAGER screen.
2. Select desired destination, **INTERNAL FILE** or **EXTERNAL FILE** (if USB is attached).
3. Select a file slot or press **Page #** to navigate **PAGE UP** or **PAGE DOWN** to show the next 4 file slots.

4. Select **SAVE**. If an existing STA file is select, it will be overwritten.
5. Select **YES** to continue. Select **NO** to cancel.
6. An alphanumeric keypad will open. Type in desired file name. Press **Enter**. Or **Esc** to cancel.

5.1.2 Load Configuration Files

1. Navigate to the FILE MANAGER screen.
2. Select desired destination, **INTERNAL FILE** or **EXTERNAL FILE** (if USB is attached).
3. Select an STA file or press **Page #** to navigate **PAGE UP** or **PAGE DOWN** to show the next 4 file slots.
4. Select **LOAD**.
5. Select **YES** to continue. Select **NO** to cancel.

5.1.3 Delete File

1. Navigate to the FILE MANAGER screen.
2. Select desired destination, **INTERNAL FILE** or **EXTERNAL FILE** (if USB is attached).
3. Select an STA, GIF, or CSV file or press **Page #** to navigate **PAGE UP** or **PAGE DOWN** to show the next 4 file slots.
4. Select **DELETE**.
5. Select **YES** to continue. Select **NO** to cancel.

5.1.4 Copy File to I:/E:

1. Navigate to the FILE MANAGER screen.
2. Select desired destination, **INTERNAL FILE** or **EXTERNAL FILE** (if USB is attached).
3. Select an STA file or press **Page #** to navigate **PAGE UP** or **PAGE DOWN** to show the next 4 file slots.
4. Select **COPY TO I:/E:**. This will move the STA from internal to external memory or external to internal memory.
5. Select **YES** to continue. Select **NO** to cancel.

5.1.5 Select

Use **SELECT** to copy multiple files at once from internal to external memory. Press **SELECT** again on a file to deselect it.

5.2 SAVE SCREEN

This function can be found in the **DATA** menu on most displays. Press SAVE SCREEN and a screenshot will be saved in the PIC folder mentioned above. The name assigned to the screenshot will start at zero, but if there are other screenshots from this units in that folder, it will assign the lowest value possible.

5.3 USB Flash Driver Requirements

The instrument features a USB host interface for connecting an external USB flash drive. Below lists the requirements of the USB flash drive as supported by the instrument:

- Meets the USB 1.0/1.1 standard
- Capacity: 32MB/256MB/2GB/4GB
- File format: FAT16, FAT32 (Format the USB memory from a Windows® operating system)

6 Specifications

All specifications apply to the unit after:

Temperature Stabilization time: 30 mins

Operating Temperature: 23 °C ± 5 °C

Relativity Humidity: ≤ 80%

Specifications are subject to change without notice.

Rd = Measured Value

Fs = Full range

6.1 Specifications

Resistance Measurement			
Reading Digits	5 ½ digits		
Measurement Range	0.1 μΩ to 110 MΩ		
Resistance Range	Test Current	Resolution	Accuracy Rd % + Fs %
20 mΩ	1 A	0.1 μΩ	0.25 + 0.001
200 mΩ		1 μΩ	0.25 + 0.001
200 mΩ	(selectable) 100 mA	1 μΩ	0.35 + 0.001
2 Ω	100 mA	10 μΩ	0.035 + 0.001
20 Ω	10 mA	100 μΩ	0.025 + 0.001
200 Ω		1 mΩ	0.01 + 0.001
2 kΩ	1 mA	10 mΩ	0.01 + 0.001
20 kΩ	100 μA	100 mΩ	0.01 + 0.005
100 kΩ		1 Ω	0.01 + 0.003
1 MΩ	10 μA	10 Ω	0.02 + 0.001
10 MΩ	1 μA	100 Ω	0.1 + 0.006
100 MΩ	100 nA	1 kΩ	0.5 + 0.040

*Accuracy = (measurement value * Rd%) + (resistance range * Fs%)*

Example calculation:

Measurement = 10.0404 Ω; RANGE = 20 Ω

*Accuracy = (10.0404 Ω * 0.025%) + (20 Ω * 0.001%) = 0.0027101 Ω*

Result: 10.0404 Ω ± .0027101 Ω

Display Digits		
	SLOW2, SLOW1, MED	FAST
Display Digits	6 digits	5 digits
Temperature range	3 digits, maximum display number: 999.9 °C	3 digits, maximum display number: 999.9 °C
Measurement Function		
Resistance Measurement Time	FAST: 7 ms, MED: 22 ms, SLOW1: 102 ms, SLOW2: 402 ms (+20 ms when DISPLAY is ON)	
Temperature Measurement Time	100 ± 10 ms	
Low Voltage Measurement (LPR)	Open voltage ≤ 60 mV Effective range: 2 Ω, 20 Ω, 200 Ω, 2 kΩ	
Average Samples	1 to 255	
Temperature Measurement		
TPTC2 Sensors Range	-10.0 °C to 99.9 °C	
Analog Input	Input Voltage Range: 0 V to 2 V	
	Temperature Range: -99.9 °C to 999.9 °C	
General specification		
External USB memory	Save / recall configuration files, screenshots, and measurement logs	
Remote interface	USB (USBTMC or virtual COM), RS232, LAN, HANDLER	
Display	24-bit, 400 x 272 touch TFT LCD screen	
Operating Temperature, Humidity	0 °C to 40 °C, ≤ 90%RH	
Temperature, Humidity for basic accuracy	23 ± 5 °C, ≤ 80%RH	
AC Input	Voltage	110 V to 240 V (±10%)
	Frequency	50 Hz to 60 Hz (±5%)
Power Consumption	≤ 30 VA	
Dimensions (WxHxD)	255 mm x 110 mm x 361 mm (10.04 in x 4.33 in x 14.22 in) (with bezel)	
Weight	Approx. 3.6 kg	

6.2 Basic Accuracy for Resistance Measurement

Range	Max display value	OVC	± (Rd% + Fs%)				Current Range	Open Circuit Voltage
			SLOW2	SLOW1	MED	FAST		
20 mΩ	20.0000 ± 0.2000	OFF	0.25+0.015	0.25+0.017	0.25+0.02	0.25+0.025	1A ±5%	5Vmax
		ON	0.25+0.001	0.25+0.001	0.25+0.001	0.25+0.004		

	mΩ							
200 mΩ	200.000 ± 2.000 mΩ	OFF	0.25+0.006	0.25+0.008	0.25+0.012	0.25+0.03	1A ±5%	5Vmax
		ON	0.25+0.001	0.25+0.001	0.25+0.001	0.25+0.002		
200 mΩ	200.000 ± 2.000 mΩ	OFF	0.35+0.01	0.35+0.012	0.35+0.015	0.35+0.03	100mA ±5%	2.6Vmax
		ON	0.35+0.001	0.35+0.001	0.35+0.002	3500+80		
2 Ω	2000.00 ± 20.00 mΩ	OFF	0.035+0.004	0.035+0.006	0.035+0.008	0.035+0.008	100mA ±5%	2.6Vmax
		ON	0.035+0.001	0.035+0.001	0.035+0.001	0.035+0.004		
20 Ω	20.0000 ± 0.2000 Ω	OFF	0.025+0.004	0.025+0.005	0.025+0.007	0.025+0.008	10mA ±5%	2.6Vmax
		ON	0.025+0.001	0.025+0.001	0.025+0.001	0.025+0.004		
200 Ω	200.000 ± 2.000 Ω	OFF	0.01+0.002	0.01+0.002	0.01+0.003	0.01+0.004	10mA ±5%	2.6Vmax
		ON	0.01+0.001	0.01+0.001	0.01+0.001	0.01+0.004		
2 kΩ	2000.00 ± 020.00 Ω	OFF	0.01+0.0015	0.01+0.002	0.01+0.004	0.01+0.005	1mA ±5%	2.6Vmax
		ON	0.01+0.001	0.01+0.001	0.01+0.001	0.01+0.004		
20 kΩ	20.0000 ± 0.2000 kΩ	OFF	0.01+0.002	0.01+0.002	0.01+0.002	0.01+0.002	100uA ±5%	2.6Vmax
		ON	0.01+0.0005	0.01+0.0005	0.01+0.0005	0.01+0.0005		
100 kΩ	110.000 ± 2.000 kΩ	----	0.01+0.003	0.01+0.003	0.01+0.004	0.01+0.005	100uA ±5%	13Vmax
1 MΩ	1100.00 ± 20.00 kΩ	----	0.02+0.001	0.02+0.003	0.02+0.004	0.02+0.005	10uA ±5%	13Vmax
10 MΩ	11.000 ± 0.2000 MΩ	----	0.1+0.006	0.1+0.009	0.1+0.01	0.3+0.012	1uA ±5%	13Vmax
100 MΩ	110.00 ± 2.000 MΩ	----	5000+200	5000+230	5000+400	30000+300	100nA ±5%	13Vmax

6.3 Resistance Measurement at Low Voltage Basic Accuracy

Accuracy in one year (23±5°C)

Range	Maximum display value	OV C	± (Rd% + Fs%)				Current Range	Open Circuit Voltage
			SLOW2	SLOW1	MED	FAST		

2 Ω	2000.00 ± 020.00 mΩ	OF	0.05+0.01	0.05+0.012	0.05+0.015	0.05+0.02	10m A±5 %	60mVmax
		F						
20 Ω	20.0000 ± 0.2000 Ω	ON	0.05+0.001	0.05+0.001	0.05+0.002	0.05+0.008	1mA ±5%	60mVmax
		OF	0.05+0.01	0.05+0.012	0.05+0.015	0.05+0.02		
200 Ω	200.000 ± 02.000 Ω	ON	0.05+0.001	0.05+0.001	0.05+0.002	0.05+0.008	100u A±5 %	60mVmax
		OF	0.05+0.01	0.05+0.012	0.05+0.015	0.05+0.02		
2 kΩ	2000.00 ± 020.00 Ω	ON	0.05+0.001	0.05+0.001	0.05+0.002	0.05+0.008	10u A±5 %	60mVmax
		OF	0.05+0.01	0.05+0.012	0.05+0.015	0.05+0.02		

6.4 Timing

The measurement speed of the instrument is determined by the following factors:

- Integral sampling period (approx. 5ms)
- Average times (measurement times)
- Measurement delay time (a time starting from the measurement start-up to the measurement beginning)
- Display on/off

Typical minimum times.

Measurement Timing		
	OVC OFF	OVC ON
FAST	7 ms	10 ms
MED	20 ms (50 Hz) 16.7 ms (60 Hz)	40 ms (50 Hz) 33.3 ms (60 Hz)
SLOW1	100 ms	200 ms
SLOW2	400 ms	800 ms
Display On	+20 ms	
Computing Time	1 ms	

Resistance Measurement Delay												
	Range (Ω)	20m	200m	2	20	200	2k	20k	100k	1M	10M	100M
FUNC R (ms)	OVC OFF	30	30	3	3	3	3	3	10	50	100	1000
	OVC ON	100	100	100	100	100	100	100	—	—	—	—
FUNC LPR (ms)	OVC OFF	—	—	3	3	3	15	—	—	—	—	—
	OVC ON	—	—	100	100	100	100	—	—	—	—	—

6.5 Accuracy for Temperature Measurement (TPTC2)

Temperature range	-10.0 to 39.9 °C	40.0 to 99.9 °C
Resolution	0.1 °C	0.1 °C
Accuracy in six months	±0.30%Rd ± 0.5 °C *	±0.30%Rd ± 1.0 °C
Accuracy in one year	±0.45%Rd ± 0.8 °C	±0.45%Rd ± 1.5 °C

*Accuracy=0.3% x measured value ± 0.5 °C

6.6 Accuracy for Temperature Measurement (Analog Input)

Analog Input	
Input voltage range	0 to 2 V
Temperature range display	-99.9 °C to 999.9 °C
Resolution	1 mV
Accuracy	±1% T _R ± 3 mV

$$\text{Accuracy} = 1\% * (T_R - T_{0V}) + 0.3\% * (T_{1V} - T_{0V})$$

T_{1V} : The temperature measured under input voltage of 1V.

T_{0V} : The temperature measured under input voltage of 0V.

T_R : The current measured temperature.

7 Remote Control

The instrument has RS232, USB (virtual COM), and LAN interfaces for remote control. This chapter will describe how users can remotely operate the instrument and use SCPI (Standard Commands for Programmable Instruments) commands via these interfaces. **4.3.5 Bus Mode** must be in the respective interface mode in order to communicate.

7.1 RS232C

For RS232C connectivity, refer to the diagram below for the pinout information. The RS232C is labeled in the rear panel and is a female DB-9 interface. Use a null modem or crossover cable where pins 2 and 3 are reversed.

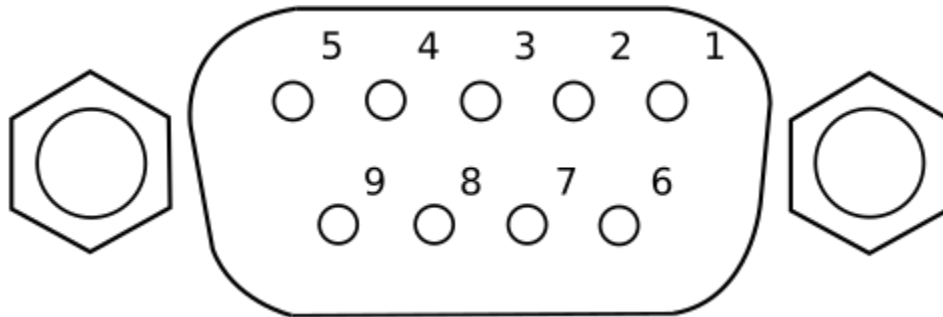

PIN	Description
1	-
2	Transmit Data
3	Receive Data
4	-
5	GND
6	-
7	-
8	-
9	-

Parameter	Description
Baud rate	9600, 19200, 28800, 38400, 48000, 57600, and 115200.
Parity and data bit	None/8 bits
Stop bit	1
Flow control	None

NOTICE

The RS232C interface does not support hardware flow control (only transmit, receive, and ground pins are used). The programmer should be aware of this communication error. Therefore, limitation and notice the command process time of the instrument. If the remote commands are sent too fast to the instrument, the internal buffer may overrun and cause a adding a delay between commands may be necessary to allow time for the meter to process.

7.2 USBTMC

USB The standard USB port is a USBTMC-compliant port that can be used for remote communication. There are no additional settings in the menu system for USB configuration. The only requirement is that the USBTMC driver be installed. It is included when a VISA software is installed on the computer. (We recommend using NI-VISA, which can be downloaded at <http://www.ni.com/visa/>).

7.3 USB (USBCDC - Virtual COM)

The standard USB port is a virtual COM port that can be used for remote communication. There are no settings in the menu system for USB configuration. The settings are the same as the settings for RS232C.

NOTICE

The USB interface does not support hardware flow control (only transmit, receive, and ground pins are used). The programmer should be aware of this limitation and notice the command process time of the instrument. If the remote commands are sent too fast to the instrument, the internal buffer may overrun and cause a communication error. Therefore, adding a delay between commands may be necessary to allow time for the meter to process.

7.4 LAN (Ethernet)

The instrument can be controlled via LAN interface. See 0

for setup instructions. Connect over Ethernet cable to a network or directly to a computer. Enter the instrument's IP address into a browser. Navigate the interface with the menu pages on the left of the screen.

Description	DC Resistance Meter
Serial Number	482H16101
Model	2841
Host name	
IP Address	10.0.1.144
VISA TCP/IP Connect String	TCP/IP::10.0.1.144::INSTR
Firmware Revision	1.5.6
MAC Address	1e-30-6c-a2-45-5e
SCPI TCP/IP Socket Port	1024

7.5 Remote Commands

The instrument supports some SCPI commands and some instrument specific commands. These commands enable a computer to remotely communicate and control the instrument over any of the supported remote interfaces: USBTMC, RS232C, and LAN.

Refer to the programming manual for details, which can be downloaded from www.bkprecision.com

8 Handler Interface

The instrument is equipped with a 50 pin Handler interface for external control and outputting measurement and sorting results. If **BIN OUT** is **BCD**, pins 14 to 50 are BCD outputs and BIN, OB, and OUT are disabled.

Mating connector: Amphenol PN:57-30500

Terminals and Their Descriptions:

Pin	I/O	Signal name	Pin	I/O	Signal name
1	IN	$\overline{\text{LOAD0}}$	26	IN	$\overline{\text{LOAD1}}$
2	IN	$\overline{\text{LOAD2}}$	27	IN	$\overline{\text{LOAD3}}$
3	IN	$\overline{\text{LOAD4}}$	28	IN	$\overline{\text{0ADJ}}$
4	IN	$\overline{\text{TRIG(IN0)}}$	29	IN	$\overline{\text{CAL}}$
5	----	Unused	30	Power	COM
6	Power	COM	31	Power	COM
7	Power	INT.GND	32	Power	INT.GND
8	Power	INT.VCC	33	Power	INT.VCC
9	Power	INT.VCC	34	Power	EXTV
10	Power	EXTV	35	Power	EXTV
11	OUT	ERR	36	OUT	INDEX
12	OUT	EOC	37	OUT	Hi
13	OUT	IN	38	OUT	Lo
14	OUT	BIN0(BCD1-0)	39	OUT	BIN1(BCD1-1)
15	OUT	BIN2(BCD1-2)	40	OUT	BIN3(BCD1-3)
16	OUT	BIN4(BCD2-0)	41	OUT	BIN5(BCD2-1)
17	OUT	BIN6(BCD2-2)	42	OUT	BIN7(BCD2-3)
18	OUT	BIN8(BCD3-0)	43	OUT	BIN9(BCD3-1)
19	OUT	OB (BCD3-2)	44	OUT	(BCD3-3)
20	OUT	(BCD4-0)	45	OUT	(BCD4-1)
21	OUT	(BCD4-2)	46	OUT	(BCD4-3)
22	OUT	OUT0(BCD5-0)	47	OUT	OUT1(BCD5-1)
23	OUT	OUT2(BCD5-2)	48	OUT	OUT3(BCD5-3)
24	OUT	OUT4(BCD6-0)	49	OUT	OUT5(BCD6-1)
25	OUT	OUT6(BCD6-2)	50	OUT	OUT7(BCD6-3)

8.1 Input Signals

$\overline{\text{0ADJ}}$: Execute one 0 calibration when the signal transitions from high to low.

$\overline{\text{CAL}}$: Execute one self-calibration when the signal transitions from high to low.

$\overline{\text{TRIG}}$: External trigger will take one measurement while this signal transitions from high to low.

1. This signal will be ignored if the trigger setting is set to internal trigger.
2. This signal will be ignored when no 4-terminal connector attached.
3. This signal will be ignored while loading the file.

$\overline{\text{LOAD0}}$ to $\overline{\text{LOAD4}}$: Load one of up to 30 internal STA configuration files. $\overline{\text{LOAD0}}$ is low-order, while $\overline{\text{LOAD4}}$ is high-order.

$\overline{\text{LOAD4}}$	$\overline{\text{LOAD3}}$	$\overline{\text{LOAD2}}$	$\overline{\text{LOAD1}}$	$\overline{\text{LOAD0}}$	File Number
0	0	0	0	0	*
0	0	0	0	1	30
0	0	0	1	0	29
0	0	0	1	1	28
0	0	1	0	0	27
0	0	1	0	1	26
0	0	1	1	0	25
0	0	1	1	1	24
0	1	0	0	0	23
0	1	0	0	1	22
0	1	0	1	0	21
0	1	0	1	1	20
0	1	1	0	0	19
0	1	1	0	1	18
0	1	1	1	0	17
0	1	1	1	1	16
1	0	0	0	0	15
1	0	0	0	1	14
1	0	0	1	0	13
1	0	0	1	1	12
1	0	1	0	0	11
1	0	1	0	1	10
1	0	1	1	0	9
1	0	1	1	1	8
1	1	0	0	0	7
1	1	0	0	1	6
1	1	0	1	0	5
1	1	0	1	1	4
1	1	1	0	0	3
1	1	1	0	1	2
1	1	1	1	0	1
1	1	1	1	1	*

Note: The file load cannot be controlled through RS232.

8.2 Output Signal

ERR: Error signal output is divided into synchronous measurement error signal output and asynchronous measurement error signal output. The measurement error signal is outputted together with EOC as synchronous error signal output, not asynchronous error signal output.

INDEX: Transitions from low to high to indicate that the instrument measurement is finished. The instrument begins calculating the DUT's resistance after the measurement is finished.

EOC: End of conversion signal. Transitions from high to low when measurement calculations begin. Transitions from low to high when measurement calculations end.

Hi, IN, Lo: Comparator results.

BIN0 to BIN9, OB (out of bins): If the DUT value conforms to the bin parameters, the corresponding bin no. output will be low. If no bins are satisfied, the OB signal will transition from high to low.

OUT0 to OUT7: Output signal controlled by :IO:OUT command. OUT0 is low-order and OUT7 is high-order. For example, if IO: OUT 52 the output is

Value	52(decimal)							
OUTX	OUT7	OUT6	OUT5	OUT4	OUT3	OUT2	OUT1	OUT0
Bit	0	0	1	1	0	1	0	0

BCD1-0 to BCD6-3: Binary coded decimal for the DUT's 6 digit measurement value. BCDx-0 is low-order and BCDx-3 is high-order. BCD1-x is low-order and BCD6-x is high-order. For example, if the measurement resistance is 498.992 the output is

Value	4				9				8				9				9				2			
BCDx-x	BCD6-				BCD5-				BCD4-				BCD3-				BCD2-				BCD1-			
	3	2	3	2	3	2	1	0	3	2	1	0	3	2	1	0	3	2	1	0	3	2	1	0
Bit	0	1	0	0	1	0	0	1	1	0	0	0	1	0	0	1	1	0	0	1	0	0	1	0

8.3 Power and Ground

COM: External power supply EXTV reference ground

EXTV: External power supply (5 to 24 VDC)

INT.GND: Internal and INT.VCC ground

INT.VCC: Internal power supply outputs 5 VDC

Note: When using internal power supply, COM and INT.GND can be shorted and EXTV and INT.VCC can be shorted. Do not short when an external power supply is used.

8.4 Isolated Output

Each input and output signal is isolated by a photoelectric coupler. The output voltage of each line is determined by the connection between a pull-up resistor and an externally applied voltage (EXTV).

The output circuit is shown as follows:

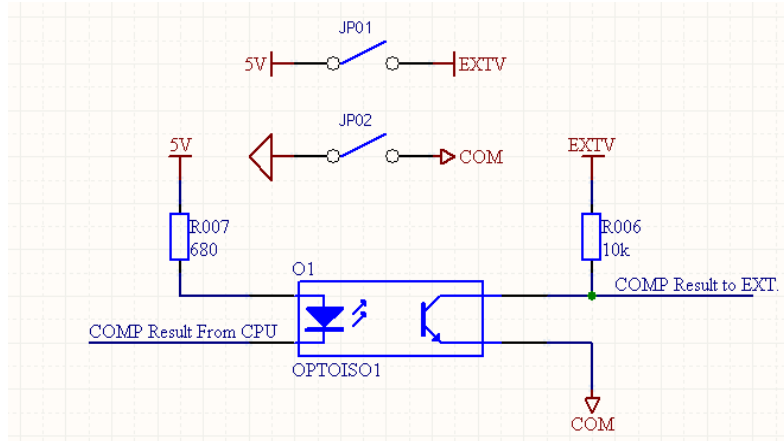

External control input circuit is shown as follows:

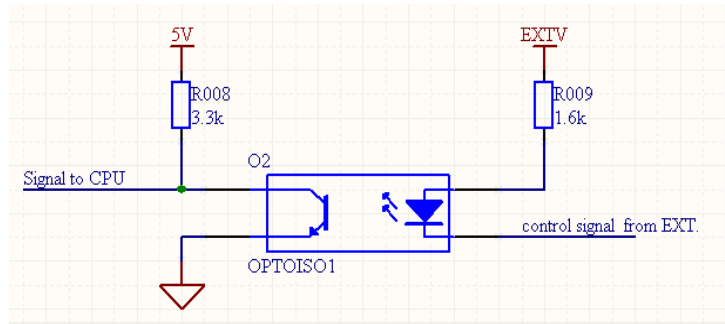

9 SERVICE INFORMATION

Warranty Service: Please go to the support and service section on our website at www.bkprecision.com to obtain a RMA #. Return the product in the original packaging with proof of purchase to the address below. Clearly state on the RMA the performance problem and return any leads, probes, connectors and accessories that you are using with the device.

Non-Warranty Service: Please go to the support and service section on our website at www.bkprecision.com to obtain a RMA #. Return the product in the original packaging to the address below. Clearly state on the RMA the performance problem and return any leads, probes, connectors and accessories that you are using with the device. Users not on an open account must include payment in the form of a money order or credit card. For the most current repair charges please refer to the service and support section on our website.

Return all merchandise to B&K Precision Corp. with prepaid shipping. The flat-rate repair charge for Non-Warranty Service does not include return shipping. Return shipping to locations in North America is included for Warranty Service. For overnight shipments and non-North American shipping fees please contact B&K Precision Corp.

B&K Precision Corp.
22820 Savi Ranch Parkway
Yorba Linda, CA 92887
www.bkprecision.com
714-921-9095

Include with the returned instrument your complete return shipping address, contact name, phone number and description of problem.

10 LIMITED THREE-YEAR WARRANTY

B&K Precision Corp. warrants to the original purchaser that its products and the component parts thereof, will be free from defects in workmanship and materials for a period of **three years** from date of purchase.

B&K Precision Corp. will, without charge, repair or replace, at its option, defective product or component parts. Returned product must be accompanied by proof of the purchase date in the form of a sales receipt.

To help us better serve you, please complete the warranty registration for your new instrument via our website www.bkprecision.com

Exclusions: This warranty does not apply in the event of misuse or abuse of the product or as a result of unauthorized alterations or repairs. The warranty is void if the serial number is altered, defaced or removed.

B&K Precision Corp. shall not be liable for any consequential damages, including without limitation damages resulting from loss of use. Some states do not allow limitations of incidental or consequential damages. So the above limitation or exclusion may not apply to you.

This warranty gives you specific rights and you may have other rights, which vary from state-to-state.

B&K Precision Corp.
22820 Savi Ranch Parkway
Yorba Linda, CA 92887
www.bkprecision.com
714-921-9095



22820 Savi Ranch Parkway

Yorba Linda, CA 92887

www.bkprecision.com

© 2017 B&K Precision Corp.

Printed in China

v081518