

Description: FPC Antenna 2.4/5.xGHz/DSRC

Series: Internal Antenna

PART NUMBER: W3334XXXXX

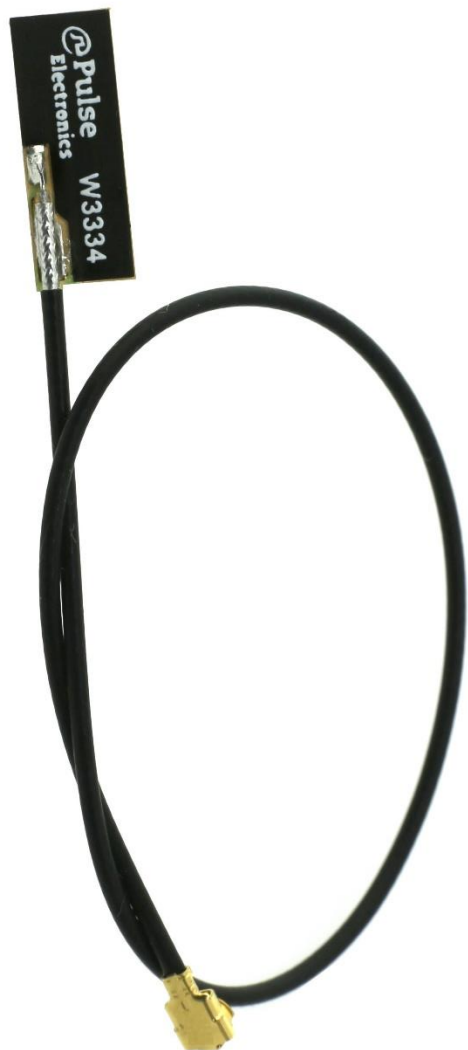

Features:

- Peak gain 4/5.5dBi
- VSWR 2:1
- Mounting with adhesive tape
- Ultra small flexible radiator 4.3x15.3x0.1mm
- Coax feed cable with U.FL compatible connector

Applications:

- 2.4/5.xGHz radios
- Dualband WiFi
- Bluetooth, BLE, ZigBee
- DSRC 5.85-5.925GHz
- Routers, set top boxes
- IoT, M2M, V2x

All dimensions are in mm / inches

Issue: 1816

In the effort to improve our products, we reserve the right to make changes judged to be necessary.

CONFIDENTIAL AND PROPRIETARY INFORMATION

This document contains confidential and proprietary information of Pulse Electronics, Inc. (Pulse) and is protected by copyright, trade secret and other state and federal laws. Its receipt or possession does not convey any rights to reproduce, disclose its contents, or to manufacture, use or sell anything it may describe. Reproduction, disclosure or use without specific written authorization of Pulse is strictly forbidden.

For more information:

Pulse Worldwide Headquarters
15255 Innovation Drive #100
San Diego, CA 92128
USA
Tel: 1-858-674-8100

Pulse/Larsen Antennas
18110 SE 34th St Bldg 2 Suite 250
Vancouver, WA 98683
USA
Tel: 1-360-944-7551

Europe Headquarters
Pulse GmbH & Do, KG
Zeppelinstrasse 15
Herrenberg, Germany
Tel: 49 7032 7806 0

Pulse (Suzhou) Wireless Products Co, Inc.
99 Huo Ju Road(#29 Bldg,4th Phase
Suzhou New District
Jiangsu Province, Suzhou 215009 PR China
Tel: 86 512 6807 9998



Description: FPC Antenna 2.4/5.xGHz/DSRC

Series: Internal Antenna

PART NUMBER: W3334XXXXX

This document covers all product variants of the following product family:

W3334B0100	100mm 1.13mm OD cable	U.FL compatible connector
W3334B0127	127mm 1.13mm OD cable	U.FL compatible connector
W3334B0150	150mm 1.13mm OD cable	U.FL compatible connector
W3334B0250	250mm 1.13mm OD cable	U.FL compatible connector
W3334B0290	290mm 1.13mm OD cable	U.FL compatible connector

Issue: 1816

In the effort to improve our products, we reserve the right to make changes judged to be necessary.

CONFIDENTIAL AND PROPRIETARY INFORMATION

This document contains confidential and proprietary information of Pulse Electronics, Inc. (Pulse) and is protected by copyright, trade secret and other state and federal laws. Its receipt or possession does not convey any rights to reproduce, disclose its contents, or to manufacture, use or sell anything it may describe. Reproduction, disclosure or use without specific written authorization of Pulse is strictly forbidden.

For more information:

Pulse Worldwide Headquarters
15255 Innovation Drive #100
San Diego, CA 92128
USA
Tel:1-858-674-8100

Pulse/Larsen Antennas
18110 SE 34th St Bldg 2 Suite 250
Vancouver, WA 98683
USA
Tel: 1-360-944-7551

Europe Headquarters
Pulse GmbH & Do, KG
Zeppelinstrasse 15
Herrenberg, Germany
Tel: 49 7032 7806 0

Pulse (Suzhou) Wireless Products Co, Inc.
99 Huo Ju Road(#29 Bldg,4th Phase
Suzhou New District
Jiangsu Province, Suzhou 215009 PR China
Tel: 86 512 6807 9998



Description: FPC Antenna 2.4/5.xGHz/DSRC

Series: Internal Antenna

PART NUMBER: W3334XXXXX

ELECTRICAL SPECIFICATIONS

Cable Length (mm)	P/N	Frequency (MHz)	Peak Gain (dBi)	Efficiency (%)	VSWR
100	W3334B0100	2400-2500	4+/-1dB	50	2:1
		4900-6000	5.5+/-1dB	70	2.5:1
127	W3334B0127	2400-2500	4+/-1dB	50	2:1
		4900-6000	5.5+/-1dB	70	2:1
150	W3334B0150	2400-2500	4+/-1dB	50	2:1
		4900-6000	5.5+/-1dB	70	2:1
250	W3334B0250	2400-2500	4+/-1dB	50	2:1
		4900-6000	5.5+/-1dB	70	2:1
290	W3334B0290	2400-2500	4+/-1dB	50	2:1
		4900-6000	5.5+/-1dB	70	2:1

Typical free space performance measured on 1mm thick PC plate

Issue: 1816

In the effort to improve our products, we reserve the right to make changes judged to be necessary.

CONFIDENTIAL AND PROPRIETARY INFORMATION

This document contains confidential and proprietary information of Pulse Electronics, Inc. (Pulse) and is protected by copyright, trade secret and other state and federal laws. Its receipt or possession does not convey any rights to reproduce, disclose its contents, or to manufacture, use or sell anything it may describe. Reproduction, disclosure or use without specific written authorization of Pulse is strictly forbidden.



Description: FPC Antenna 2.4/5.xGHz/DSRC

Series: Internal Antenna

PART NUMBER: W3334XXXXX

MECHANICAL SPECIFICATIONS

FPC size	14.3 X 5.3 X0.1[0.56 X 0.21 X 0.004]	mm[inch]
Connector type	U.FL compatible	
Cable type	$\varphi = 1.13[0.04]$	mm[inch]
Cable length	Optional	mm[inch]
Adhesive	3M467	

ENVIRONMENTAL SPECIFICATIONS

Operating temperature	-40/+85 ° C
-----------------------	-------------

Description: FPC Antenna 2.4/5.xGHz/DSRC

Series: Internal Antenna

PART NUMBER: W3334XXXXX

MECHANICAL DRAWING

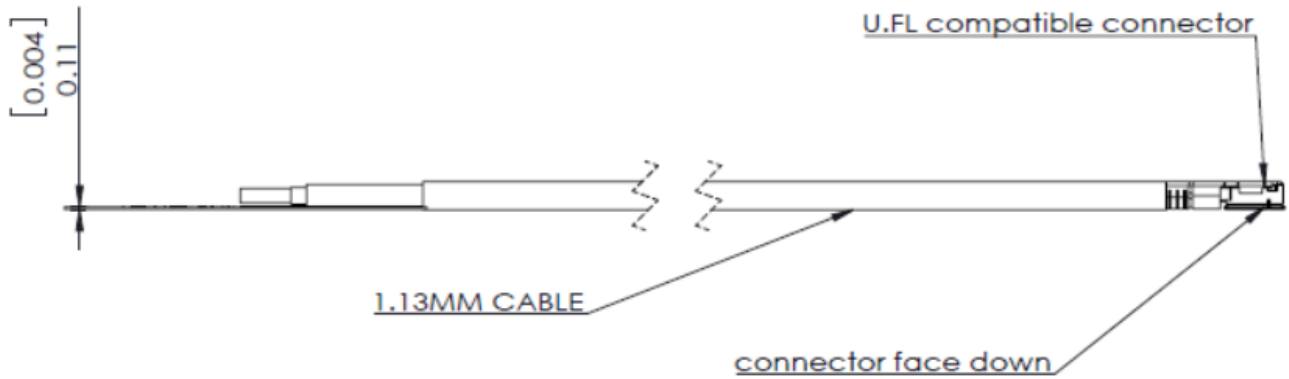
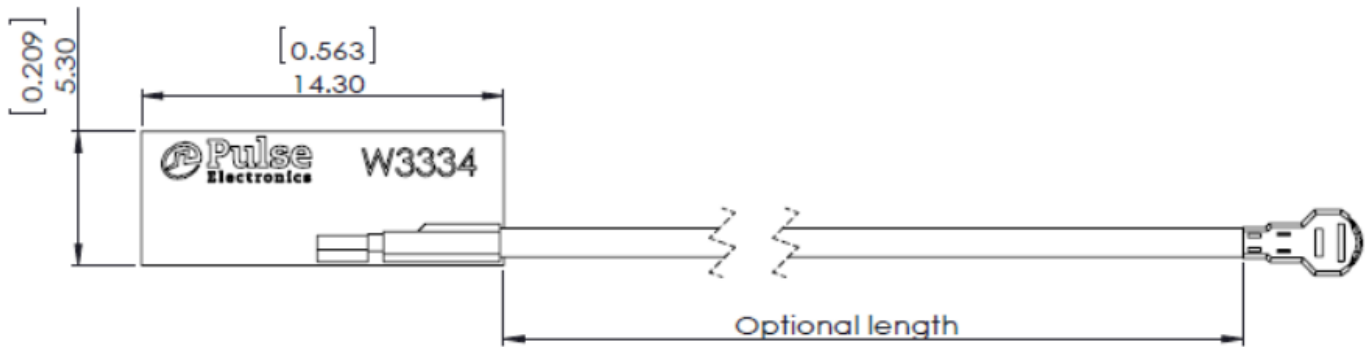

Issue: 1816

In the effort to improve our products, we reserve the right to make changes judged to be necessary.

CONFIDENTIAL AND PROPRIETARY INFORMATION

This document contains confidential and proprietary information of Pulse Electronics, Inc. (Pulse) and is protected by copyright, trade secret and other state and federal laws. Its receipt or possession does not convey any rights to reproduce, disclose its contents, or to manufacture, use or sell anything it may describe. Reproduction, disclosure or use without specific written authorization of Pulse is strictly forbidden.

Description: FPC Antenna 2.4/5.xGHz/DSRC

Series: Internal Antenna

PART NUMBER: W3334XXXXX

CHARTS

VSWR

W3334 measured with polycarbonate plate

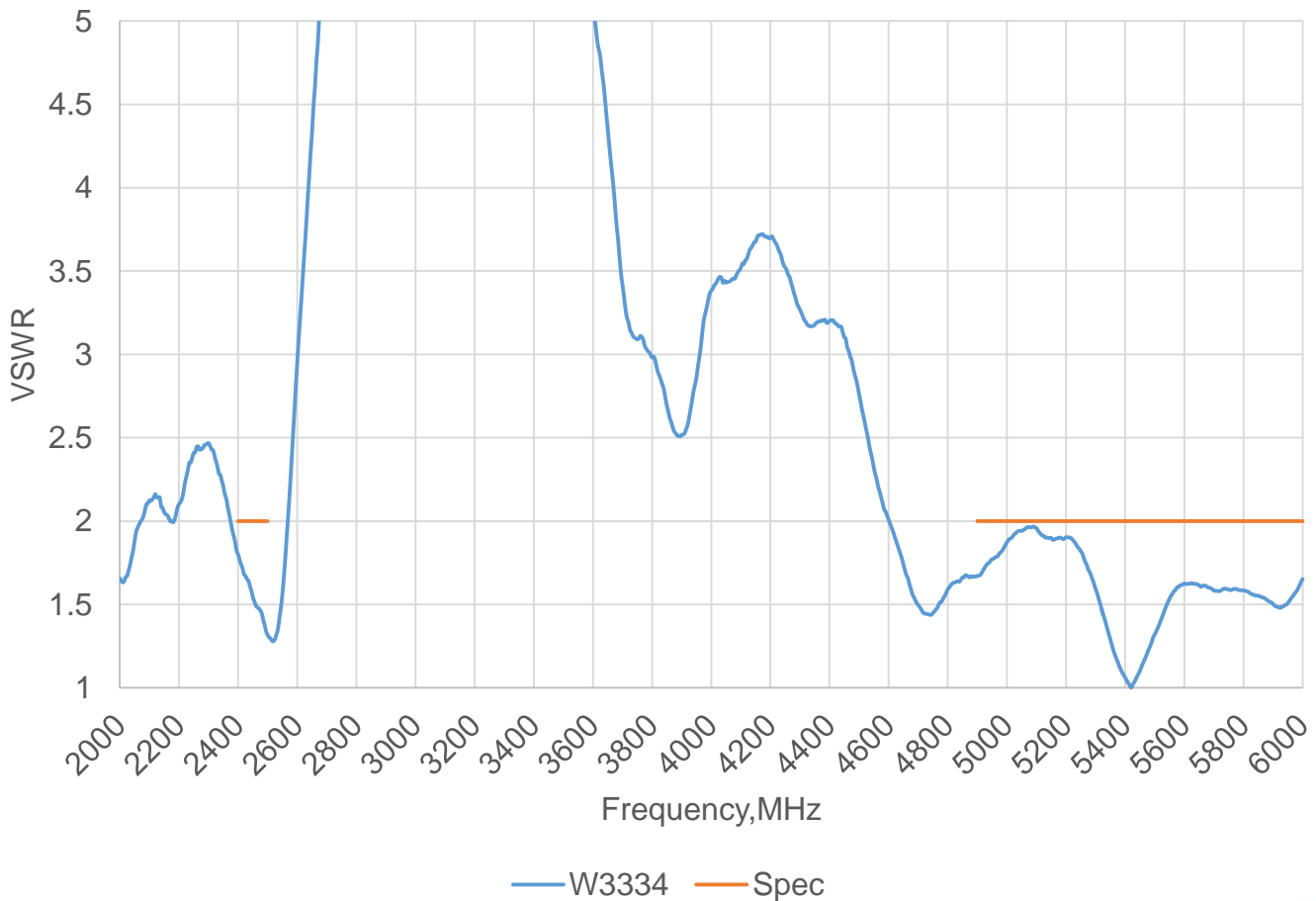

Note: Antenna tested on 1mm thickness PC plate with 150mm feed cable

Issue: 1816

In the effort to improve our products, we reserve the right to make changes judged to be necessary.

CONFIDENTIAL AND PROPRIETARY INFORMATION

This document contains confidential and proprietary information of Pulse Electronics, Inc. (Pulse) and is protected by copyright, trade secret and other state and federal laws. Its receipt or possession does not convey any rights to reproduce, disclose its contents, or to manufacture, use or sell anything it may describe. Reproduction, disclosure or use without specific written authorization of Pulse is strictly forbidden.

Description: FPC Antenna 2.4/5.xGHz/DSRC

Series: Internal Antenna

PART NUMBER: W3334XXXXX

CHARTS

Efficiency

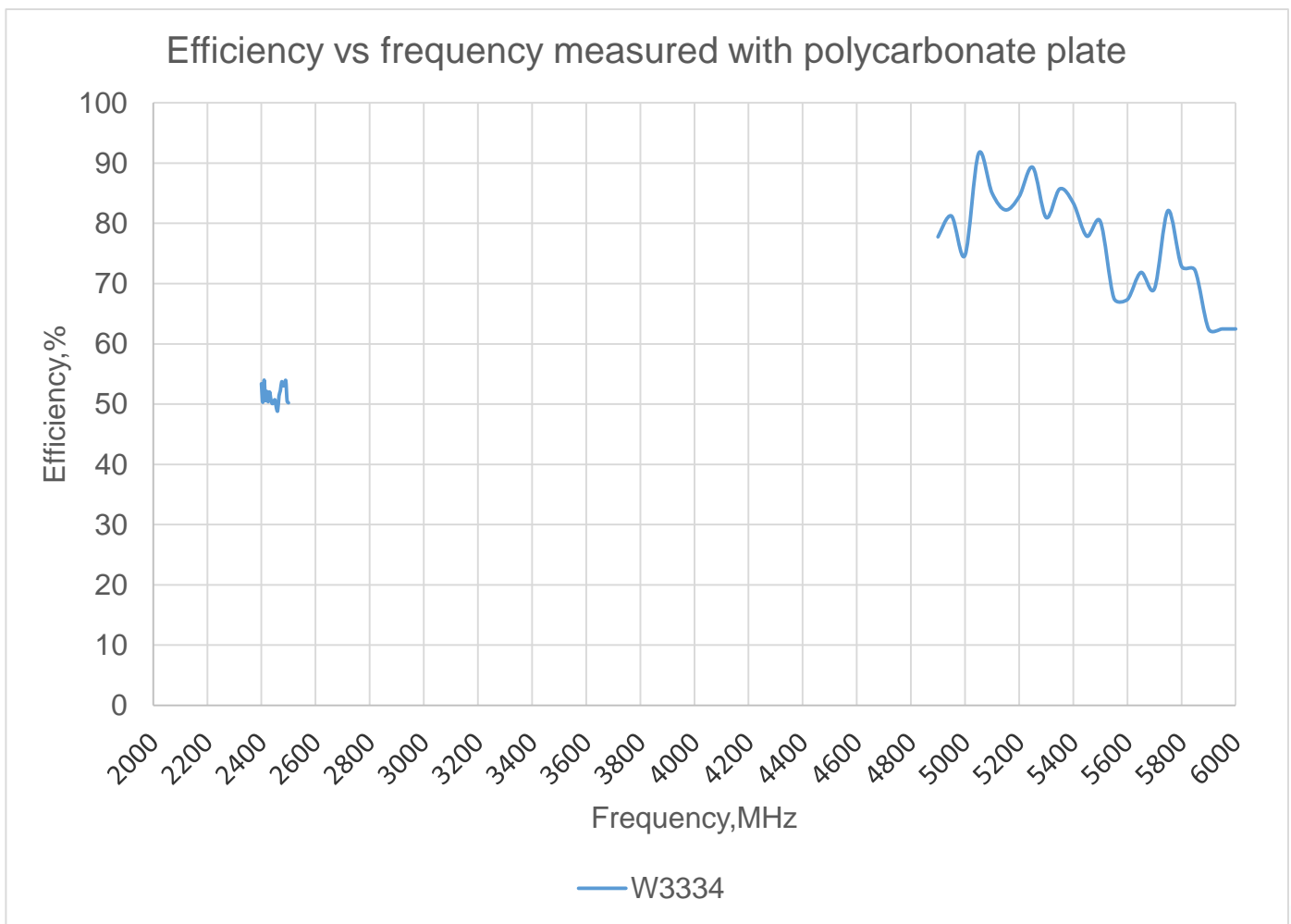

Note: Antenna tested on 1mm thickness PC plate with 150mm feed cable

Issue: 1816

In the effort to improve our products, we reserve the right to make changes judged to be necessary.

CONFIDENTIAL AND PROPRIETARY INFORMATION

This document contains confidential and proprietary information of Pulse Electronics, Inc. (Pulse) and is protected by copyright, trade secret and other state and federal laws. Its receipt or possession does not convey any rights to reproduce, disclose its contents, or to manufacture, use or sell anything it may describe. Reproduction, disclosure or use without specific written authorization of Pulse is strictly forbidden.

Description: FPC Antenna 2.4/5.xGHz/DSRC

Series: Internal Antenna

PART NUMBER: W3334XXXXX

CHARTS

Peak Gain

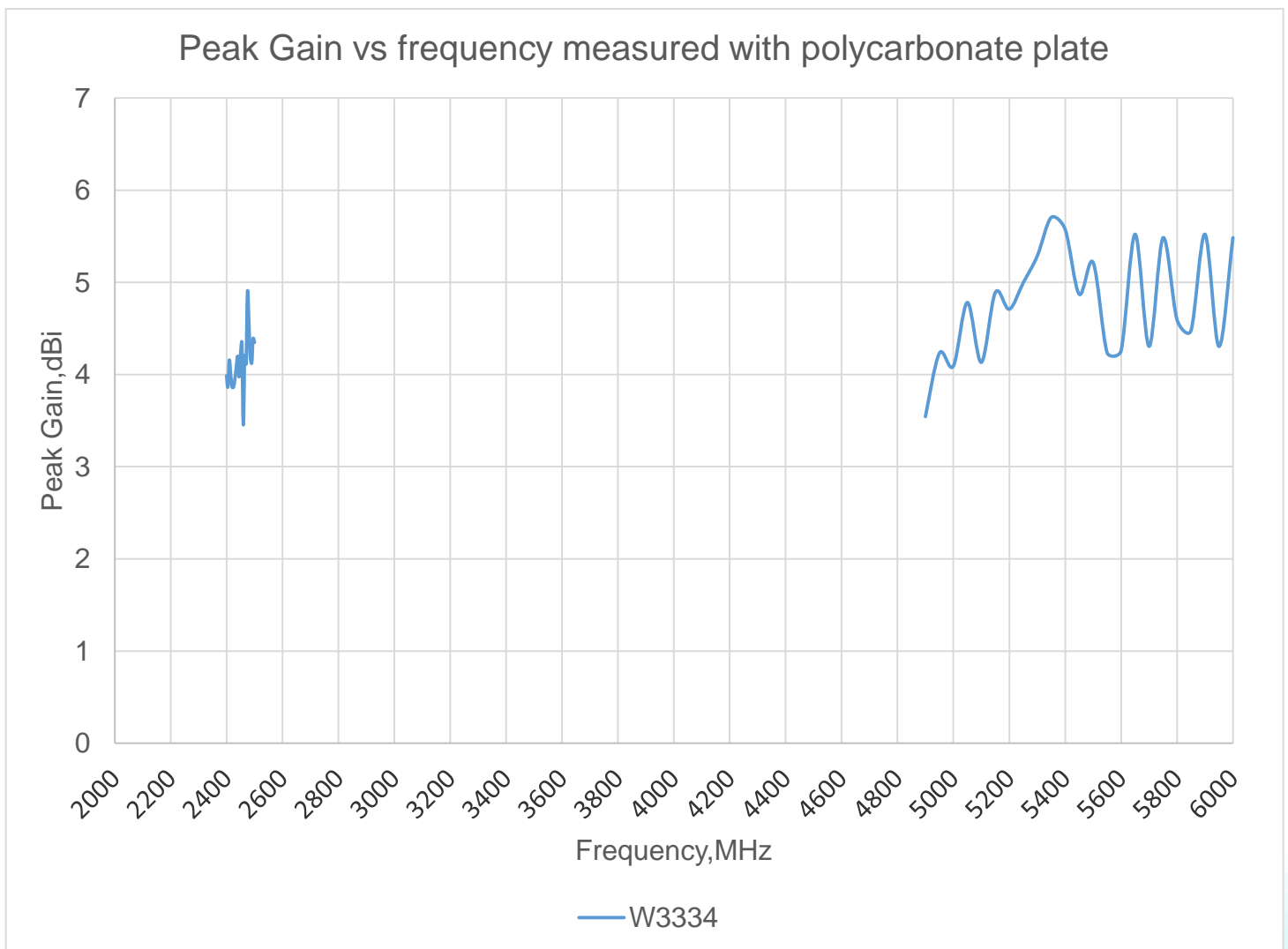

Note: Antenna tested on 1mm thickness PC plate with 150mm feed cable

Issue: 1816

In the effort to improve our products, we reserve the right to make changes judged to be necessary.

CONFIDENTIAL AND PROPRIETARY INFORMATION

This document contains confidential and proprietary information of Pulse Electronics, Inc. (Pulse) and is protected by copyright, trade secret and other state and federal laws. Its receipt or possession does not convey any rights to reproduce, disclose its contents, or to manufacture, use or sell anything it may describe. Reproduction, disclosure or use without specific written authorization of Pulse is strictly forbidden.

Description: FPC Antenna 2.4/5.xGHz/DSRC

Series: Internal Antenna

PART NUMBER: W3334XXXXX

CHARTS

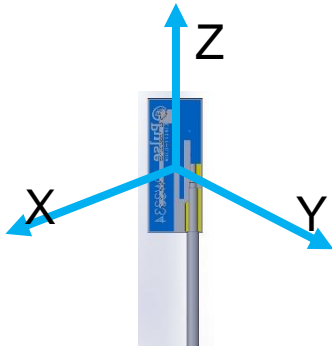

Gain Plots

XY Plane

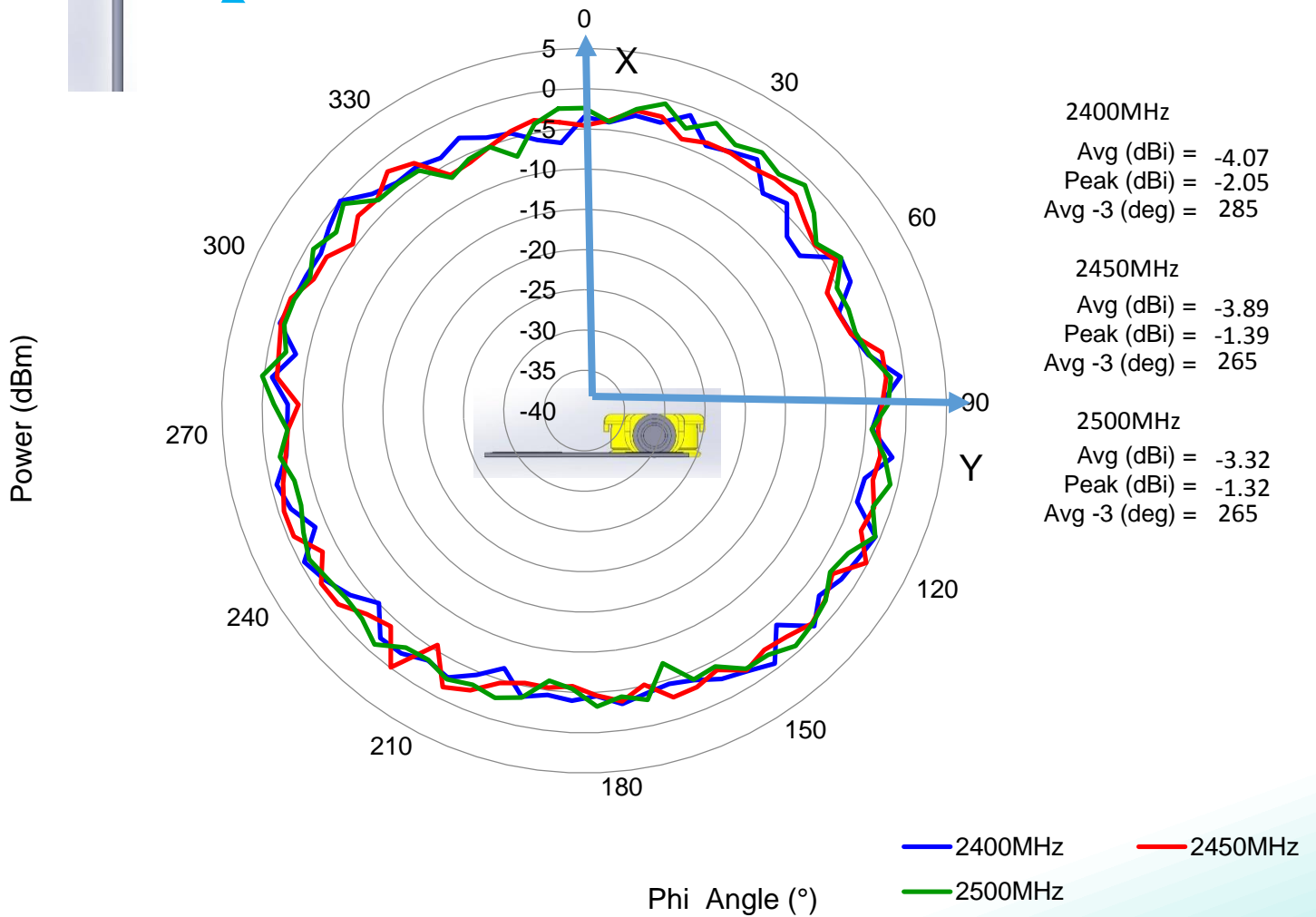

Note: Antenna tested on 1mm thickness PC plate with 150mm feed cable

Issue: 1816

In the effort to improve our products, we reserve the right to make changes judged to be necessary.

CONFIDENTIAL AND PROPRIETARY INFORMATION

This document contains confidential and proprietary information of Pulse Electronics, Inc. (Pulse) and is protected by copyright, trade secret and other state and federal laws. Its receipt or possession does not convey any rights to reproduce, disclose its contents, or to manufacture, use or sell anything it may describe. Reproduction, disclosure or use without specific written authorization of Pulse is strictly forbidden.



Description: FPC Antenna 2.4/5.xGHz/DSRC

Series: Internal Antenna

PART NUMBER: W3334XXXXX

CHARTS

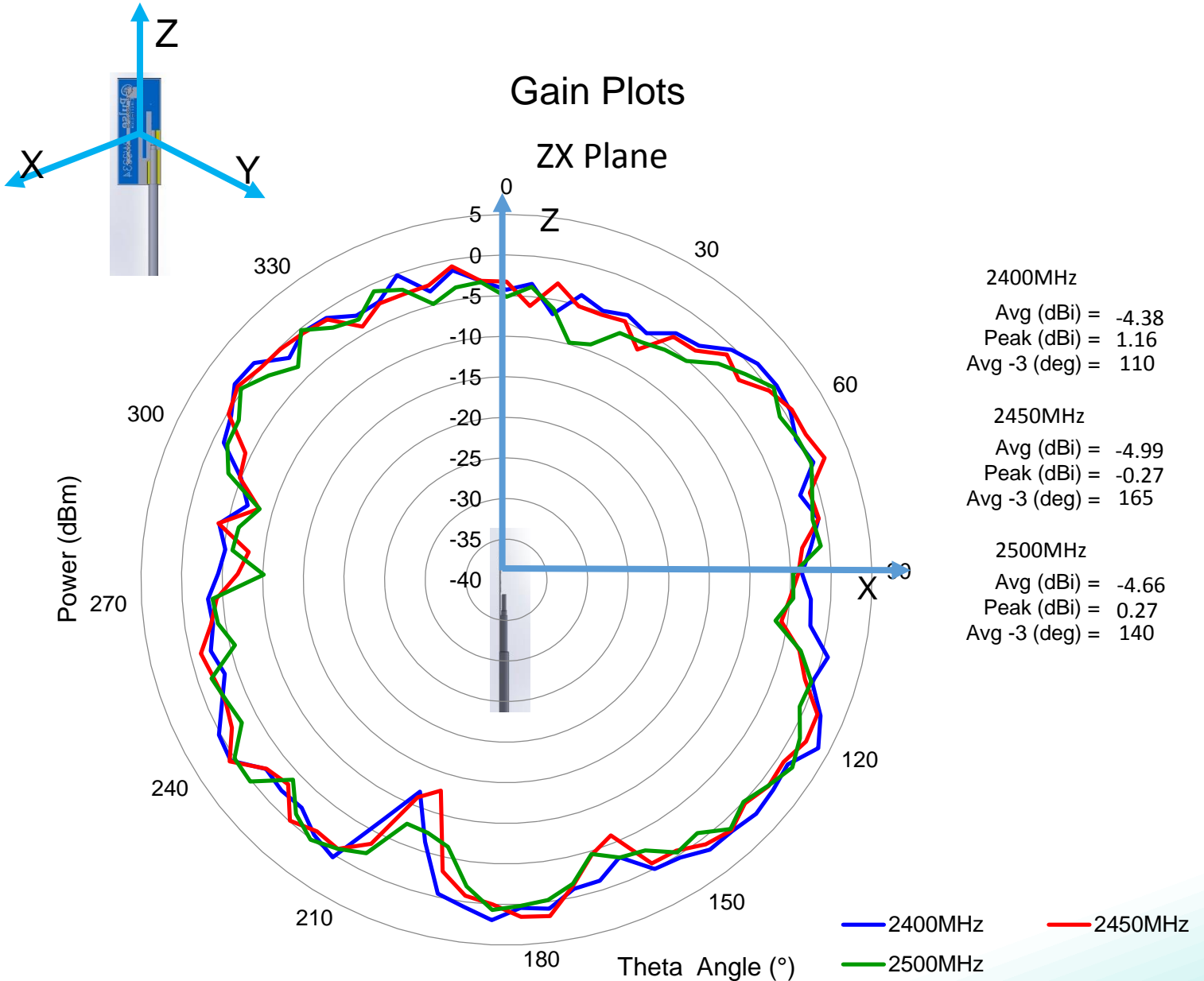

Note: Antenna tested on 1mm thickness PC plate with 150mm feed cable

Issue: 1816

In the effort to improve our products, we reserve the right to make changes judged to be necessary.

CONFIDENTIAL AND PROPRIETARY INFORMATION

This document contains confidential and proprietary information of Pulse Electronics, Inc. (Pulse) and is protected by copyright, trade secret and other state and federal laws. Its receipt or possession does not convey any rights to reproduce, disclose its contents, or to manufacture, use or sell anything it may describe. Reproduction, disclosure or use without specific written authorization of Pulse is strictly forbidden.

Description: FPC Antenna 2.4/5.xGHz/DSRC

Series: Internal Antenna

PART NUMBER: W3334XXXXX

CHARTS

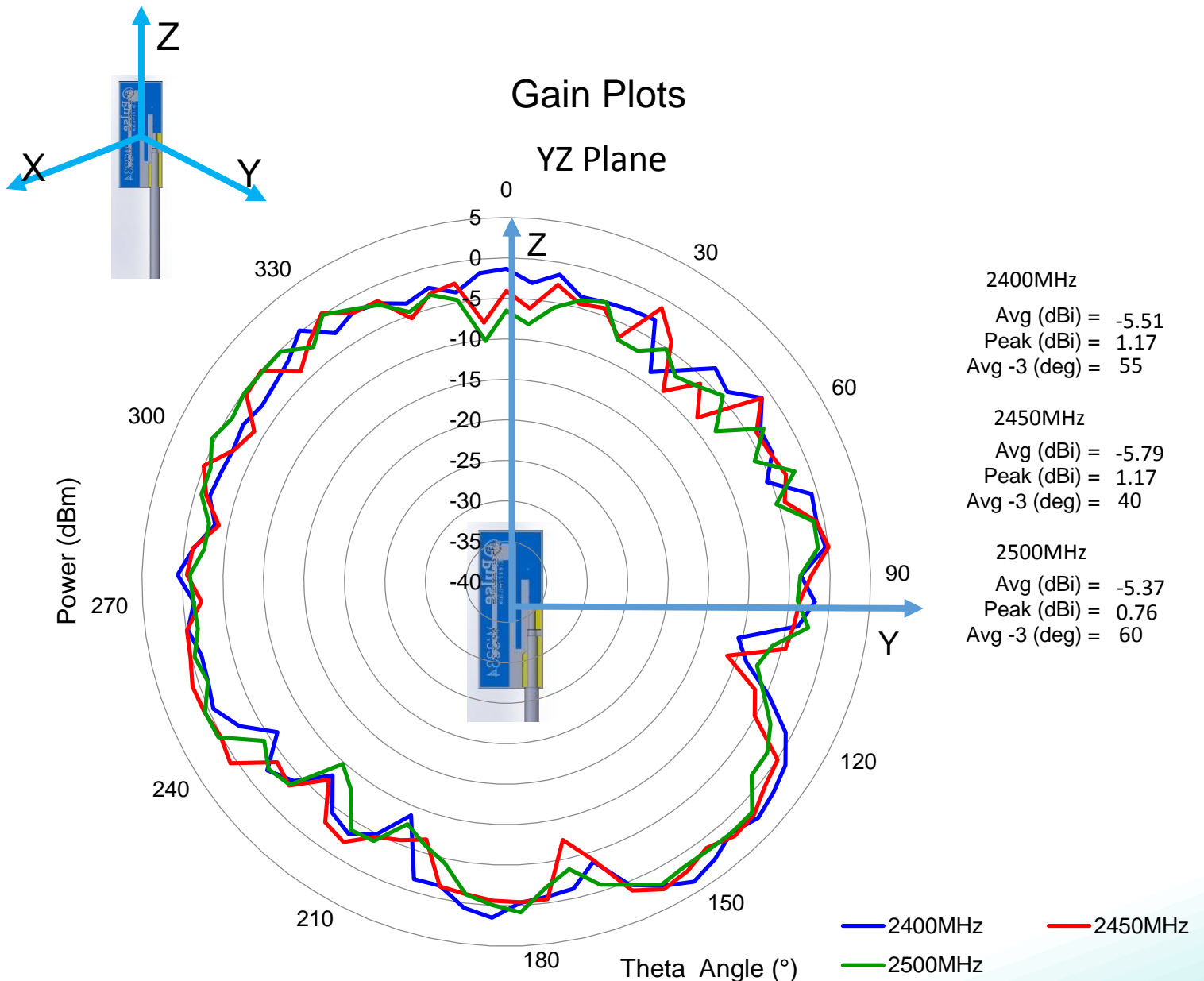

Note: Antenna tested on 1mm thickness PC plate with 150mm feed cable

Issue: 1816

In the effort to improve our products, we reserve the right to make changes judged to be necessary.

CONFIDENTIAL AND PROPRIETARY INFORMATION

This document contains confidential and proprietary information of Pulse Electronics, Inc. (Pulse) and is protected by copyright, trade secret and other state and federal laws. Its receipt or possession does not convey any rights to reproduce, disclose its contents, or to manufacture, use or sell anything it may describe. Reproduction, disclosure or use without specific written authorization of Pulse is strictly forbidden.

Description: FPC Antenna 2.4/5.xGHz/DSRC

Series: Internal Antenna

PART NUMBER: W3334XXXXX

CHARTS

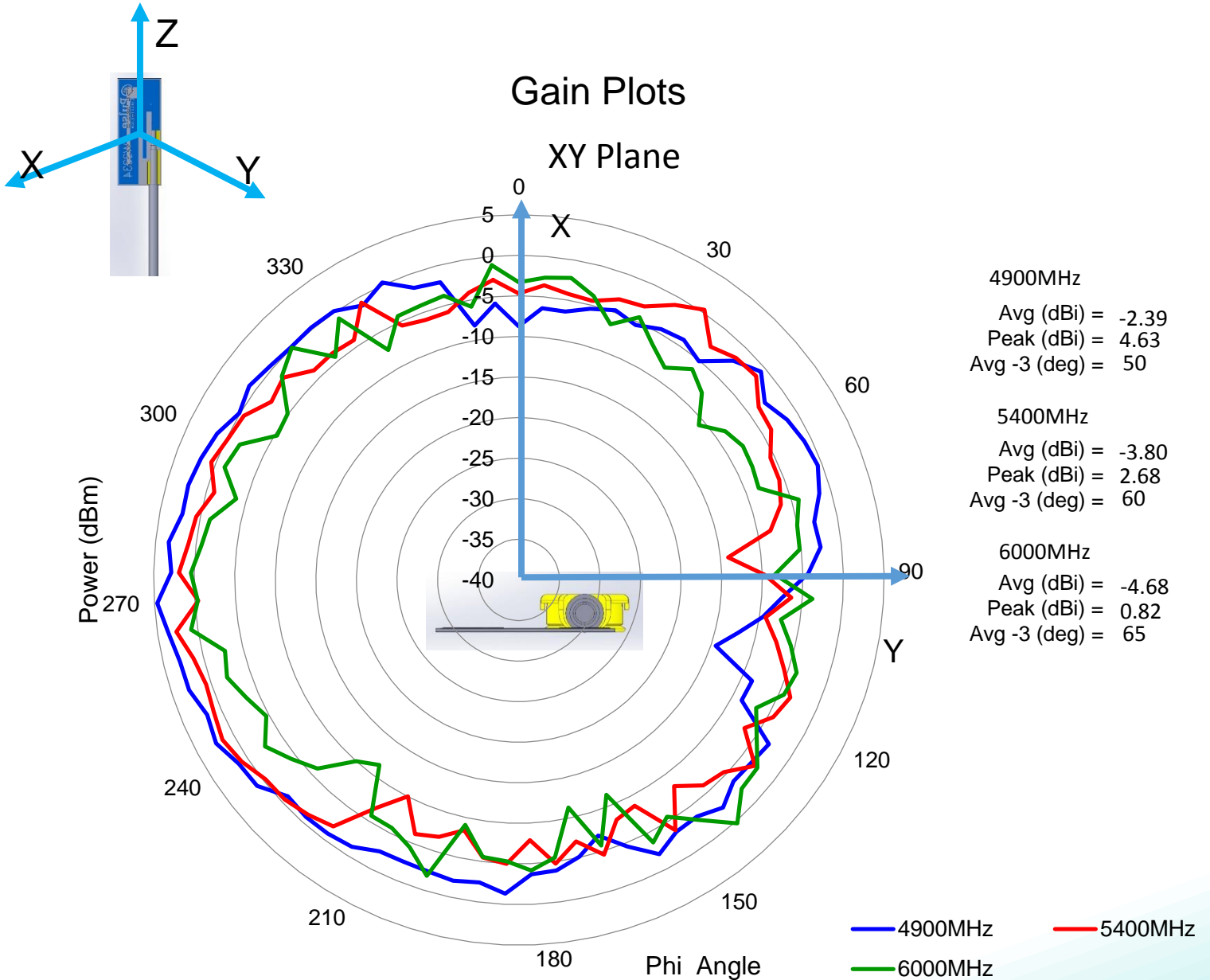

Note: Antenna tested on 1mm thickness PC plate with 150mm feed cable

Issue: 1816

In the effort to improve our products, we reserve the right to make changes judged to be necessary.

CONFIDENTIAL AND PROPRIETARY INFORMATION

This document contains confidential and proprietary information of Pulse Electronics, Inc. (Pulse) and is protected by copyright, trade secret and other state and federal laws. Its receipt or possession does not convey any rights to reproduce, disclose its contents, or to manufacture, use or sell anything it may describe. Reproduction, disclosure or use without specific written authorization of Pulse is strictly forbidden.

Description: FPC Antenna 2.4/5.xGHz/DSRC

Series: Internal Antenna

PART NUMBER: W3334XXXXX

CHARTS

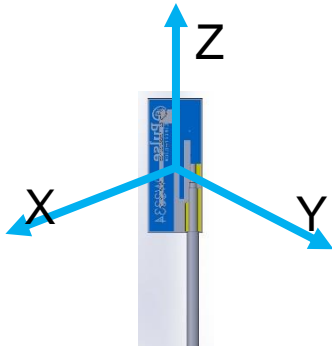

Gain Plots

ZX Plane

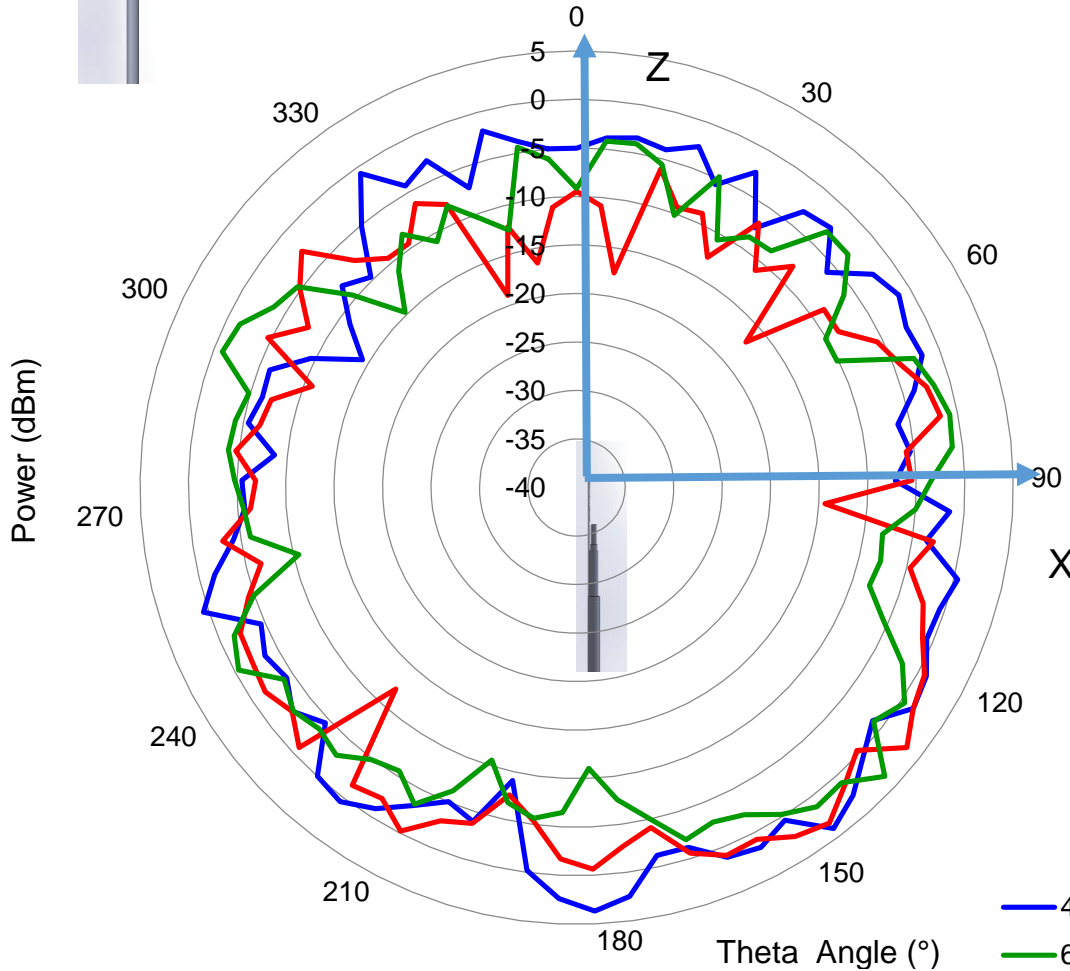

4900MHz
 Avg (dBi) = -3.30
 Peak (dBi) = 3.99
 Avg -3 (deg) = 35

5400MHz
 Avg (dBi) = -5.52
 Peak (dBi) = 3.32
 Avg -3 (deg) = 35

6000MHz
 Avg (dBi) = -5.24
 Peak (dBi) = 3.52
 Avg -3 (deg) = 10

— 4900MHz — 5400MHz
 — 6000MHz

Note: Antenna tested on 1mm thickness PC plate with 150mm feed cable

Issue: 1816

In the effort to improve our products, we reserve the right to make changes judged to be necessary.

CONFIDENTIAL AND PROPRIETARY INFORMATION

This document contains confidential and proprietary information of Pulse Electronics, Inc. (Pulse) and is protected by copyright, trade secret and other state and federal laws. Its receipt or possession does not convey any rights to reproduce, disclose its contents, or to manufacture, use or sell anything it may describe. Reproduction, disclosure or use without specific written authorization of Pulse is strictly forbidden.

Description: FPC Antenna 2.4/5.xGHz/DSRC

Series: Internal Antenna

PART NUMBER: W3334XXXXX

CHARTS

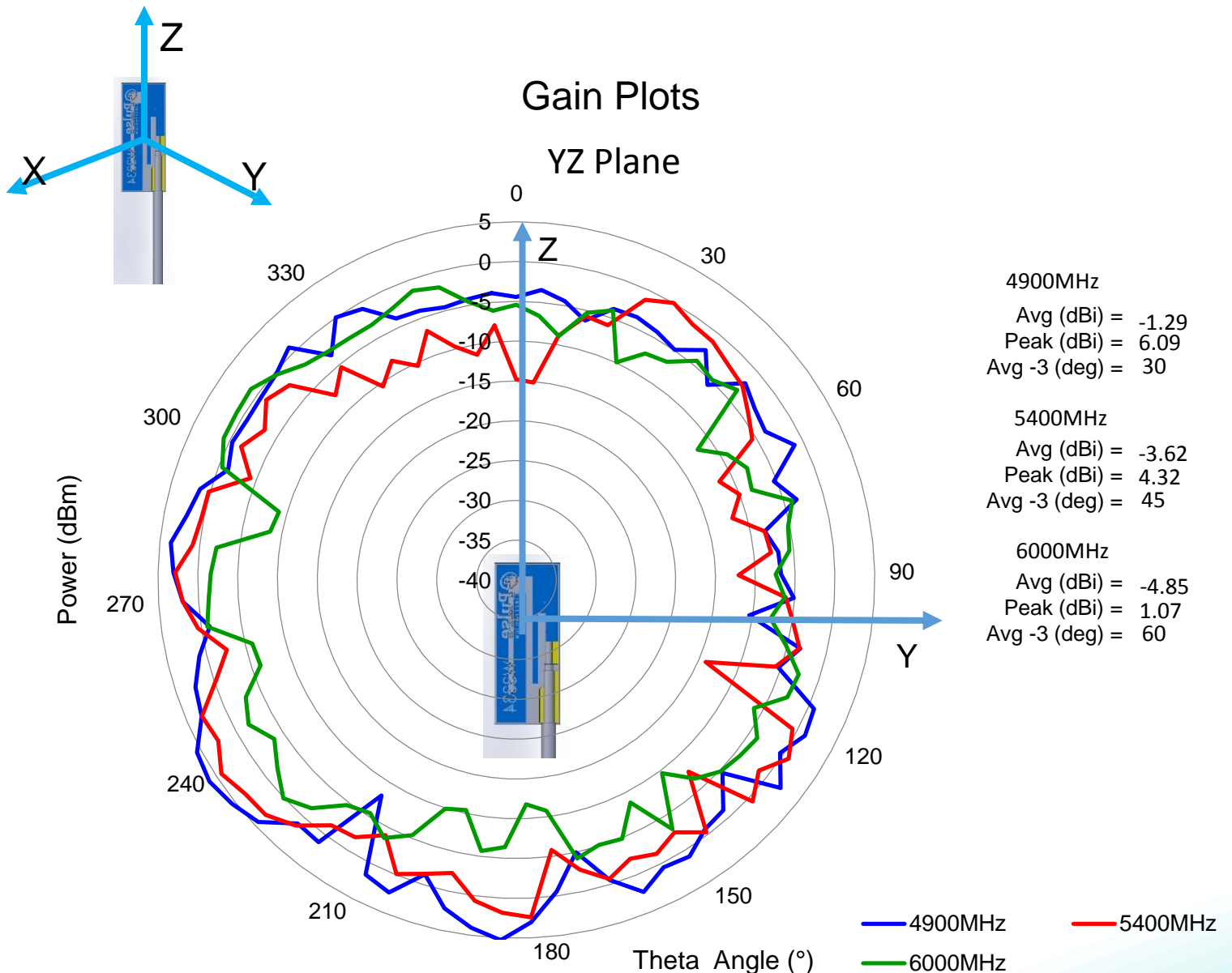

Note: Antenna tested on 1mm thickness PC plate with 150mm feed cable

Issue: 1816

In the effort to improve our products, we reserve the right to make changes judged to be necessary.

CONFIDENTIAL AND PROPRIETARY INFORMATION

This document contains confidential and proprietary information of Pulse Electronics, Inc. (Pulse) and is protected by copyright, trade secret and other state and federal laws. Its receipt or possession does not convey any rights to reproduce, disclose its contents, or to manufacture, use or sell anything it may describe. Reproduction, disclosure or use without specific written authorization of Pulse is strictly forbidden.

Description: FPC Antenna 2.4/5.xGHz/DSRC

Series: Internal Antenna

PART NUMBER: W3334XXXXX

PACKAGING

5PCS/PE bag
20 PE bag/foam bag
12 foam bag/ carton box

Total 1200PCS/Carton box



Issue: 1816

In the effort to improve our products, we reserve the right to make changes judged to be necessary.

CONFIDENTIAL AND PROPRIETARY INFORMATION

This document contains confidential and proprietary information of Pulse Electronics, Inc. (Pulse) and is protected by copyright, trade secret and other state and federal laws. Its receipt or possession does not convey any rights to reproduce, disclose its contents, or to manufacture, use or sell anything it may describe. Reproduction, disclosure or use without specific written authorization of Pulse is strictly forbidden.