

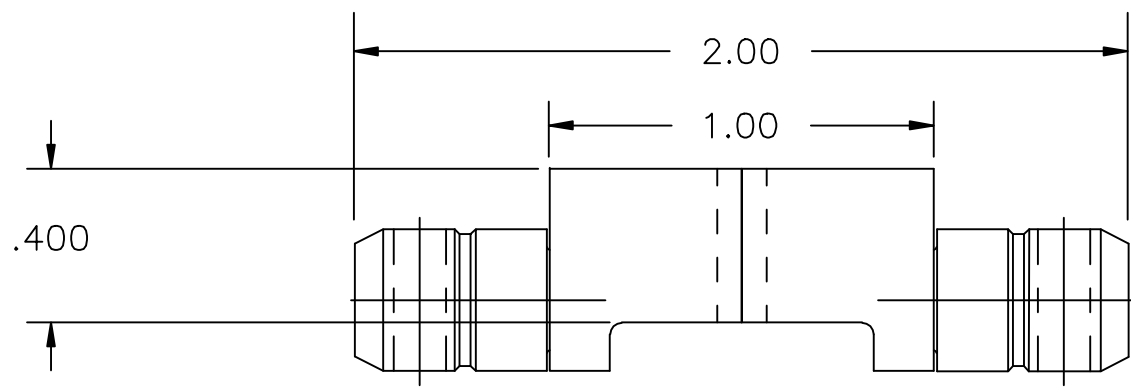

**UNCONTROLLED DOCUMENT
WILL NOT BE UPDATED**

620419-ENV

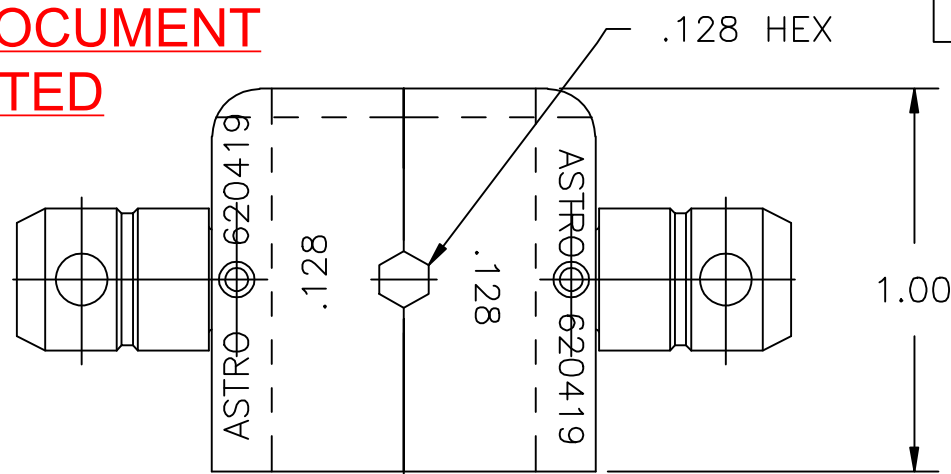

NOTES: I. THIS IS AN AUTOCAD DRAWING DO NOT CHANGE MANUALLY.

					THESE DRAWINGS, SPECIFICATIONS OR OTHER DATA ARE AND REMAIN, THE PROPERTY OF ASTRO TOOL CORP. AND MUST BE RETURNED UPON REQUEST. THEY CONTAIN INFORMATION OWNED AND/OR DEVELOPED BY ASTRO AT ITS OWN PRIVATE EXPENSE AND MAY NOT BE USED, DUPLICATED OR DISCLOSED TO OTHERS, IN WHOLE OR IN PART FOR DESIGN, MANUFACTURE OR PROCUREMENT WITHOUT THE WRITTEN PERMISSION OF ASTRO TOOL CORP. EACH AND EVERY TIME.	SCALE: N.T.S.	UNLESS OTHERWISE SPECIFIED: DECIMALS: .XXX ± .005 .XX ± .010 .X ± .030 ANGLES: ± 1°	 21615 S.W. TUALATIN VALLEY HWY., BEAVERTON OR 97006	CAGE 58164
A	NEW RELEASE.	DYO	07-20-11	MMK		DWN BY: DYO DATE: 07-20-11 APPROVED:			DESCRIPTION: ENVELOPE DRAWING: 620419 DIE SET, FOR M22520/5-01 FRAME
REV.	DESCRIPTION	BY	DATE	APR.	PART NO.		A	620419-ENV	