

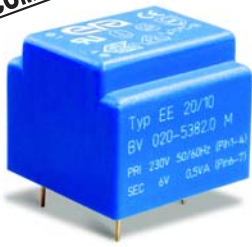









# LAMINATED TRANSFORMERS

## Type EE20 / 10 - 0.50VA



**AGENCY APPROVALS** 

1. UL 506, File E113449  **us**
2. UL 1585, File E175197 **Class 2/3**
3. EN61558 

-  Frequency 50/60Hz
-  Potted under vacuum
-  Split-bobbin
-  Temperature class ta 70°C/B
-  Short-circuit-proof (where noted: 1/2/3\* under Agency Approvals)
-  Weight: 0.035kg
-  Packaging unit: 40 pieces (tray)

Primary (V)	Secondary (V / mA)	No-Load Voltage (V)	Schematic No.	Part Number	Agency Approvals
230	6 / 83	8.90	1	020-5382.0	1/2/3*
230	9 / 55	13.50	1	020-5383.0	1/2/3*
230	12 / 42	19.40	1	020-5384.0	1/2/3*
230	15 / 34	24.60	1	020-5385.0	1/2/3*
230	18 / 28	29.50	1	020-5386.0	1/2/3*
230	24 / 21	39.60	1	020-5387.0	1/2/3*
230	2x6 / 42	2x9.60	2	020-5388.0	1/2/3*
230	2x9 / 28	2x15.20	2	020-5389.0	1/2/3*
230	2x12 / 21	2x19.10	2	020-5390.0	1/2/3*
230	2x15 / 16	2x23.30	2	020-5391.0	1/2/3*
230	2x18 / 14	2x29.2	2	020-5392.0	1
230	2x24 / 10	2x38.8	2	020-5393.0	1
115	6 / 83	8.90	1	020-5370.0	1/2/3*
115	9 / 55	13.50	1	020-5371.0	1/2/3*
115	12 / 42	19.40	1	020-5372.0	1/2/3*
115	15 / 34	24.60	1	020-5373.0	1/2/3*
115	18 / 28	29.50	1	020-5374.0	1/2/3*
115	24 / 21	39.60	1	020-5375.0	1/2/3*
115	2x6 / 42	2x9.60	2	020-5376.0	1/2/3*
115	2x9 / 28	2x15.20	2	020-5377.0	1/2/3*
115	2x12 / 21	2x19.10	2	020-5378.0	1/2/3*
115	2x15 / 16	2x23.30	2	020-5379.0	1/2/3*
115	2x18 / 14	2x29.20	2	020-5380.0	1
115	2x24 / 10	2x38.80	2	020-5381.0	1

### Mechanical

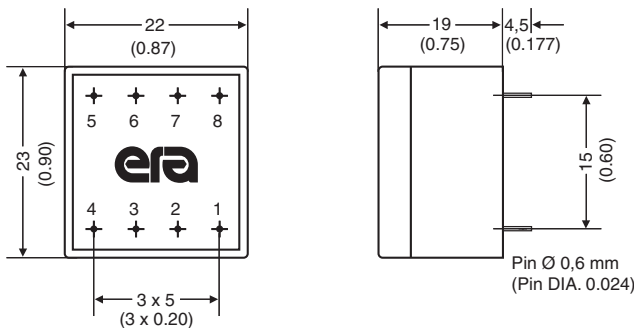

**\*NOTE:** When checking the approval status of this product with VDE, add the prefix "BV" and the suffix "M" to the orderable Part Number (these letters will also be found on the part label). **The prefix and suffix are not part of the orderable Part Number.**

### Schematics

