

Low-Power Long Range LoRa[®] Technology Transceiver Module

General Features

- On-Board LoRaWAN™ Protocol Stack
- ASCII Command Interface over UART
- Compact Form Factor: 17.8 x 26.7 x 3.34 mm
- Castellated SMT Pads for Easy and Reliable PCB Mounting
- Environmentally Friendly, RoHS Compliant
- European R&TTE Directive Assessed Radio Module
- Device Firmware Upgrade (DFU) over UART, see “RN2483 LoRa[®] Technology Module Command Reference User’s Guide” (DS40001784)

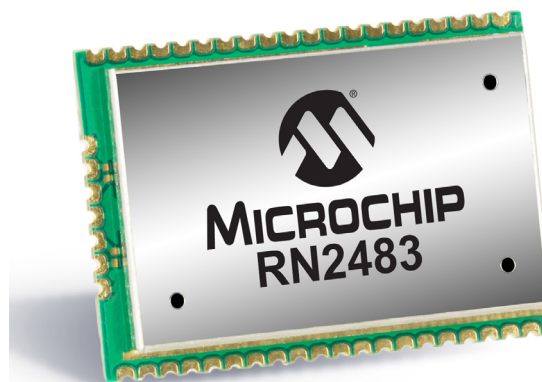

Operational

- Single Operating Voltage: 2.1V to 3.6V (3.3V typical)
- Temperature Range: -40°C to +85°C
- Low-Power Consumption
- Programmable RF Communication Bit Rate up to 300 kbps with FSK Modulation, 10937 bps with LoRa[®] Technology Modulation
- Integrated MCU, Crystal, EU1-64 Node Identity Serial EEPROM, Radio Transceiver with Analog Front End, Matching Circuitry
- 14 GPIOs for Control and Status, Shared with 13 Analog Inputs

RF/Analog Features

- Low-Power Long Range Transceiver Operating in the 433 MHz and 868 MHz Frequency Bands
- High Receiver Sensitivity: Down to -146 dBm
- TX Power: Adjustable up to +14 dBm high Efficiency PA
- FSK, GFSK, and LoRa Technology Modulation
- IIP3 = -11 dBm
- Up to 15 km Coverage at Suburban and up to 5 km Coverage at Urban Area

Description

Microchip’s RN2483 Low-Power Long Range LoRa Technology Transceiver module provides an easy to use, low-power solution for long range wireless data transmission. The advanced command interface offers rapid time to market.

The RN2483 module complies with the LoRaWAN Class A protocol specifications. It integrates RF, a baseband controller, command Application Programming Interface (API) processor, making it a complete long range solution.

The RN2483 module is suitable for simple long range sensor applications with external host MCU.

Applications

- Automated Meter Reading
- Home and Building Automation
- Wireless Alarm and Security Systems
- Industrial Monitoring and Control
- Machine to Machine (M2M)
- Internet of Things (IoT)

Table of Contents

1.0	Device Overview	3
2.0	General Specifications	6
3.0	Typical Hardware Connections.....	9
4.0	Physical Dimensions	11
5.0	Application Information.....	12
6.0	Regulatory Approval	13
	Appendix A: Revision History	15
	The Microchip Web Site	17
	Customer Change Notification Service	17
	Customer Support.....	17
	Product Identification System.....	19

TO OUR VALUED CUSTOMERS

It is our intention to provide our valued customers with the best documentation possible to ensure successful use of your Microchip products. To this end, we will continue to improve our publications to better suit your needs. Our publications will be refined and enhanced as new volumes and updates are introduced.

If you have any questions or comments regarding this publication, please contact the Marketing Communications Department via E-mail at docerrors@microchip.com. We welcome your feedback.

Most Current Data Sheet

To obtain the most up-to-date version of this data sheet, please register at our Worldwide Web site at:

<http://www.microchip.com>

You can determine the version of a data sheet by examining its literature number found on the bottom outside corner of any page. The last character of the literature number is the version number, (e.g., DS30000000A is version A of document DS30000000).

Errata

An errata sheet, describing minor operational differences from the data sheet and recommended workarounds, may exist for current devices. As device/documentation issues become known to us, we will publish an errata sheet. The errata will specify the revision of silicon and revision of document to which it applies.

To determine if an errata sheet exists for a particular device, please check with one of the following:

- Microchip's Worldwide Web site; <http://www.microchip.com>
- Your local Microchip sales office (see last page)

When contacting a sales office, please specify which device, revision of silicon and data sheet (include literature number) you are using.

Customer Notification System

Register on our web site at www.microchip.com to receive the most current information on all of our products.

1.0 DEVICE OVERVIEW

The RN2483 transceiver module features LoRa Technology RF modulation, which provides long range spread spectrum communication with high interference immunity.

Using LoRa Technology modulation technique, RN2483 can achieve a receiver sensitivity of -146 dBm. The high sensitivity combined with the integrated +14 dBm power amplifier yields industry leading link budget, which makes it optimal for applications requiring extended range and robustness.

LoRa Technology modulation also provides significant advantages in both blocking and selectivity compared to the conventional modulation techniques, solving the traditional design compromise between extended range, interference immunity, and low-power consumption.

The RN2483 module delivers exceptional phase noise, selectivity, receiver linearity, and IIP3 for significantly lower power consumption. [Figure 1-1](#), [Figure 1-2](#), and [Figure 1-3](#) show the top view, the pinout, and the block diagram of the module.

FIGURE 1-1: RN2483 TOP VIEW

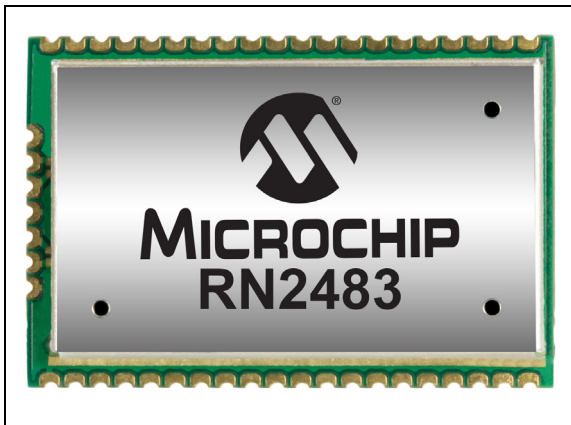
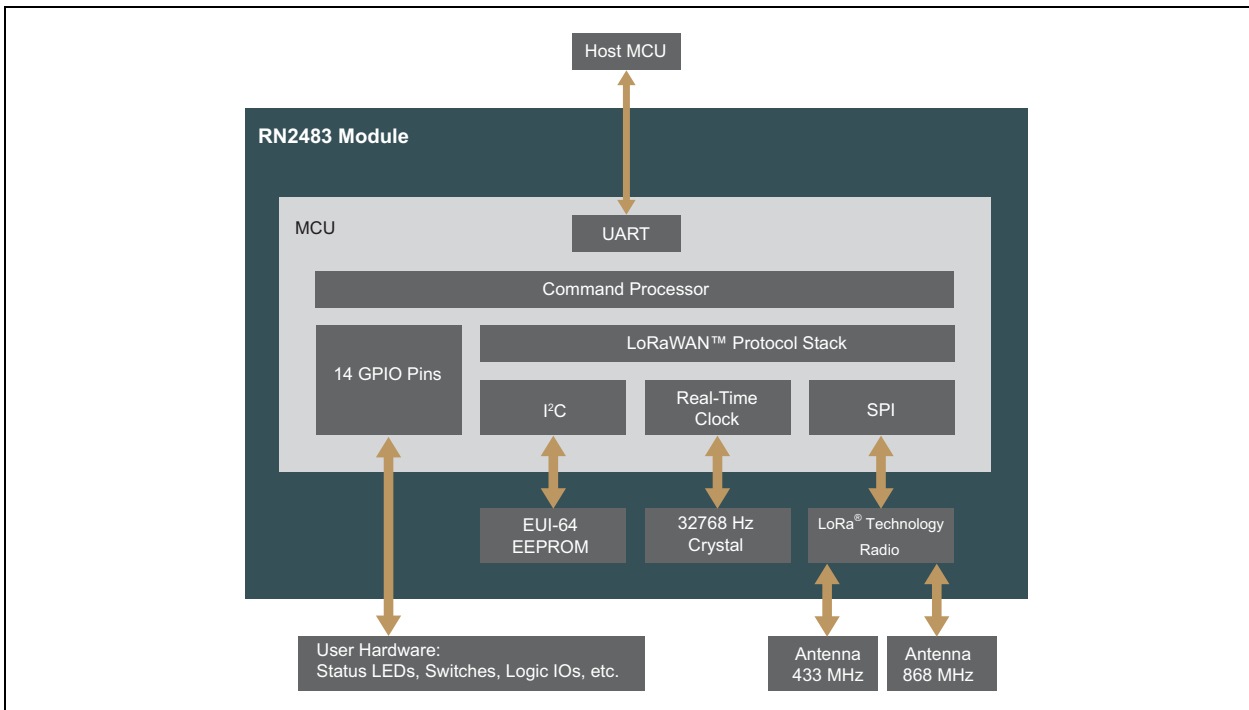

FIGURE 1-2: RN2483 PIN DIAGRAM

28	GND	27	GND	26	GND	25	RFL	24	GND	23	RPH	22	GND	21	GND	20	GND
29	NC															19	NC
30	PGC_INT															18	NC
31	PGD_INT															17	NC
32	RESET															16	NC
33	GND															15	NC
34	VDD															14	GPIO10
35	GPIO0															13	GPIO11
36	GPIO1															12	VDD
37	GPIO2															11	GND
38	GPIO3															10	GPIO12
39	GPIO4															9	GPIO13
40	GPIO5															8	GND
41	GND															7	UART_RX
42	NC															6	UART_TX
43	GPIO6															5	RESERVED
44	GPIO7															4	RESERVED
45	GPIO8															3	UART_CTS
46	GPIO9															2	UART_RTS
47	GND															1	GND

FIGURE 1-3: RN2483 BLOCK DIAGRAM



RN2483

Table 1-1 describes the RN2483 pins.

TABLE 1-1: PIN DESCRIPTION

Pin	Name	Type	Description
1	GND	Power	Ground supply terminal
2	UART_RTS	Output	Communication UART RTS signal ⁽¹⁾ , or GPIO
3	UART_CTS	Input	Communication UART CTS signal ⁽¹⁾ , or GPIO
4	RESERVED	—	Do not connect
5	RESERVED	—	Do not connect
6	UART_TX	Output	Communication UART Transmit (TX)
7	UART_RX	Input	Communication UART Receive (RX)
8	GND	Power	Ground supply terminal
9	GPIO13	Input/Output	General purpose I/O pin or analog input
10	GPIO12	Input/Output	General purpose I/O pin or analog input
11	GND	Power	Ground supply terminal
12	VDD	Power	Positive supply terminal
13	GPIO11	Input/Output	General purpose I/O pin or analog input
14	GPIO10	Input/Output	General purpose I/O pin or analog input
15	NC	—	Not connected
16	NC	—	Not connected
17	NC	—	Not connected
18	NC	—	Not connected
19	NC	—	Not connected
20	GND	Power	Ground supply terminal
21	GND	Power	Ground supply terminal
22	GND	Power	Ground supply terminal
23	RFH	RF analog	RF signal pin for high band
24	GND	Power	Ground supply terminal
25	RFL	RF analog	RF signal pin for low band
26	GND	Power	Ground supply terminal
27	GND	Power	Ground supply terminal
28	GND	Power	Ground supply terminal
29	NC	—	Not connected
30	PGC_INT	Input/Output	Internal MCU ICSP program clock or general purpose I/O pin ⁽²⁾
31	PGD_INT	Input/Output	Internal MCU ICSP program data or general purpose I/O pin ⁽²⁾
32	RESET	Input	Active-low device Reset input
33	GND	Power	Ground supply terminal
34	VDD	Power	Positive supply terminal
35	GPIO0	Input/Output	General purpose I/O pin or analog input
36	GPIO1	Input/Output	General purpose I/O pin or analog input
37	GPIO2	Input/Output	General purpose I/O pin or analog input
38	GPIO3	Input/Output	General purpose I/O pin or analog input
39	GPIO4	Input/Output	General purpose I/O pin
40	GPIO5	Input/Output	General purpose I/O pin or analog input
41	GND	Power	Ground supply terminal
42	NC	—	Not connected

TABLE 1-1: PIN DESCRIPTION (CONTINUED)

Pin	Name	Type	Description
43	GPIO6	Input/Output	General purpose I/O pin or analog input
44	GPIO7	Input/Output	General purpose I/O pin or analog input
45	GPIO8	Input/Output	General purpose I/O pin or analog input
46	GPIO9	Input/Output	General purpose I/O pin or analog input
47	GND	Power	Ground supply terminal

Note 1: Optional handshake lines are supported in future firmware releases.

2: The “RN2483 LoRa[®] Technology Module Command Reference User’s Guide” (DS40001784F) uses the pin name TEST0 for PGC_INT and TEST1 for PGD_INT.

RN2483

2.0 GENERAL SPECIFICATIONS

Table 2-1 provides the general specifications for the module. Table 2-2, Table 2-3, and Table 2-4 provide the electrical characteristics, current consumption, and

dimensions of the module, respectively. Table 2-5 shows the RF output power calibration data. Table 2-6 shows the RF output power at different supply voltages and temperatures.

TABLE 2-1: GENERAL SPECIFICATIONS

Specification	Description
Frequency Band	863.000 MHz to 870.000 MHz; 433.050 MHz to 434.790 MHz
Modulation Method	FSK, GFSK, and LoRa® Technology modulation
Maximum Over-the-Air Data Rate	300 kbps with FSK modulation; 10937 bps with LoRa Technology modulation
RF Connection	Board edge connection
Interface	UART
Operation Range	Up to 15 km coverage at suburban; up to 5 km coverage at urban area
Sensitivity at 1% PER	-146 dBm ⁽¹⁾
RF TX Power	Adjustable up to max. 10 dBm on 433 MHz band (limited to meet regulations); max. 14 dBm on the 868 MHz band ⁽²⁾
Temperature (operating)	-40°C to +85°C
Temperature (storage)	-40°C to +115°C
Humidity	10% ~ 90% non-condensing

Note 1: Dependent on modulation settings, Receiver Bandwidth (RBW), and Spreading Factor (SF).

2: TX power is adjustable. For more information, refer to the “RN2483 LoRa® Technology Module Command Reference User’s Guide” (DS40001784).

TABLE 2-2: ELECTRICAL CHARACTERISTICS

Parameter	Min.	Typ.	Max.	Units
Supply Voltage	2.1	—	3.6	V
Voltage on any pin with respect to VSS (except VDD) and RESET	-0.3	—	VDD + 0.3	V
Voltage on VDD with respect to VSS	-0.3	—	3.9	V
Voltage on RESET with respect to VSS	0	—	+11	V
Input Clamp Current (I _{IK}) (V _I < 0 or V _I > VDD)	—	—	+/-20	mA
Output Clamp Current (I _{OK}) (V _O < 0 or V _O > VDD)	—	—	+/-20	mA
GPIO sink/source current each	—	—	25/25	mA
Total GPIO sink/source current	—	—	200/185	mA
RAM Data Retention Voltage (in Sleep mode or Reset state)	1.5	—	—	V
VDD Start Voltage to ensure internal Power-on Reset signal	—	—	0.7	V
VDD Rise Rate to ensure internal Power-on Reset signal	0.05	—	—	V/ms
Brown-out Reset Voltage	1.75	1.9	2.05	V
Logic Input Low Voltage	—	—	0.15 x VDD	V
Logic Input High Voltage	0.8 x VDD	—	—	V
Input Leakage at <25°C (VSS < V _{PIN} < VDD, Pin at high-impedance)	—	0.1	50	nA
Input Leakage at +60°C (VSS < V _{PIN} < VDD, Pin at high-impedance)	—	0.7	100	nA
Input Leakage at +85°C (VSS < V _{PIN} < VDD, Pin at high-impedance)	—	4	200	nA
RF Input Level	—	—	+10	dBm

TABLE 2-3: CURRENT CONSUMPTION

Mode	Temperature (°C)	Typical Current (mA)		
		VDD = 2.1V	VDD = 3.3V	VDD = 3.6V
Idle	-40 to +85	1.7	2.8	3.1
Transmit	25	28.6	38.9	44.5
Sleep	-40	0.0011	0.0013	0.0014
	25	0.0015	0.0016	0.0016
	85	0.002	0.0026	0.0026

TABLE 2-4: MODULE DIMENSIONS

Parameter	Value
Dimensions	17.8 x 26.7 x 3.34 mm
Weight	2.05g

TABLE 2-5: OUTPUT POWER OF TX POWER SETTING

Band	TX Power Setting	Output Power (dBm)	Typical Supply Current at 3.3V (mA)
868 MHz	-3	-4.0	17.3
	-2	-2.9	18.0
	-1	-1.9	18.7
	0	-1.7	20.2
	1	-0.6	21.2
	2	0.4	22.3
	3	1.4	23.5
	4	2.5	24.7
	5	3.6	26.1
	6	4.7	27.5
	7	5.8	28.8
	8	6.9	30.0
	9	8.1	31.2
	10	9.3	32.4
	11	10.4	33.7
12	11.6	35.1	
13	12.5	36.5	
14	13.5	38.0	
15	14.1	38.9	

RN2483

TABLE 2-5: OUTPUT POWER OF TX POWER SETTING (CONTINUED)

Band	TX Power Setting	Output Power (dBm)	Typical Supply Current at 3.3V (mA)
433 MHz	-3	-3.5	14.7
	-2	-2.3	15.1
	-1	-1.3	15.6
	0	-2.3	15.8
	1	-1.2	16.4
	2	-0.1	17.0
	3	1.0	17.7
	4	2.1	18.5
	5	3.2	19.4
	6	4.3	20.3
	7	5.4	21.4
	8	6.5	22.3
	9	7.6	23.3
	10	8.8	24.5
	11	9.9	25.8
12	10.9	27.3	
13	11.9	28.8	
14	12.9	30.7	
15	13.6	32.9	

TABLE 2-6: OUTPUT POWER OF SUPPLY VOLTAGE AND TEMPERATURE

Temperature (°C)	Typical Output Power at 868 MHz (dBm)		
	VDD = 2.1V	VDD = 3.3V	VDD = 3.6V
-40	10.5	13.8	13.7
25	10.0	14.1	14.6
85	9.1	13.4	13.7

TABLE 2-7: OUTPUT POWER OF SUPPLY VOLTAGE AND TEMPERATURE

Temperature (°C)	Typical Output Power at 434 MHz (dBm)		
	VDD = 2.1V	VDD = 3.3V	VDD = 3.6V
-40	10.1	13.2	13.2
25	9.7	13.6	14.2
85	9.3	13.0	13.4

3.0 TYPICAL HARDWARE CONNECTIONS

Figure 3-1 shows the typical hardware connections.

FIGURE 3-1: HARDWARE CONNECTIONS

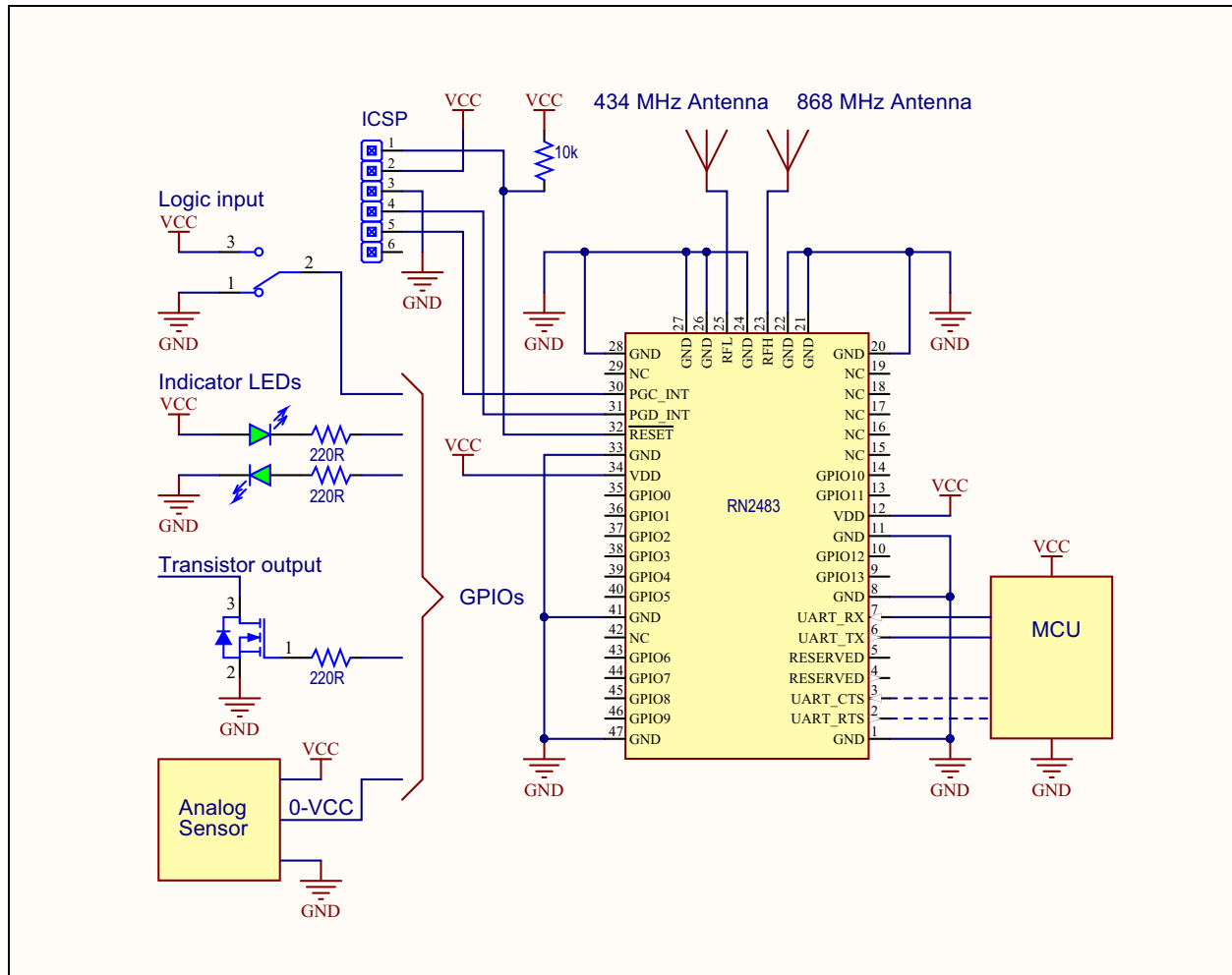

3.1 Interface to Host MCU

The RN2483 module has a dedicated UART interface to communicate with a host controller. Optional handshake lines are supported in future firmware releases. The “RN2483 LoRa® Technology Module Command Reference User’s Guide” (DS40001784) provides a detailed UART command description. Table 3-1 shows the default settings for the UART communication.

TABLE 3-1: DEFAULT UART SETTINGS

Specification	Description
Baud Rate	57600 bps
Packet Length	8 bit
Parity Bit	No
Stop Bits	1 bit
Hardware Flow Control	No

3.2 GPIO Pins (GPIO0-GPIO13)

The module has 14 GPIO pins. These lines can be connected to switches, LEDs, and relay outputs. The pins can be either logic inputs or outputs, and some pins (see Table 1-1) have analog input capability that can be accessed via the module firmware. These pins have limited sink and source capabilities. Electrical characteristics are described in Table 2-2. For more information, see “RN2483 LoRa® Technology Module Command Reference User’s Guide” (DS40001784).

3.3 RF Connections (RFL, RFH)

RFL is the RF analog port for the lower frequency band (433 MHz) while RFH is for the higher frequency band (868 MHz). When routing RF paths, use proper strip lines with an impedance of 50 Ohm.

RN2483

3.4 $\overline{\text{RESET}}$ Pin

The $\overline{\text{RESET}}$ pin of the module is an active-low logic input. An internal weak pull-up resistor is enabled when the pin is configured as the MCLR input.

3.5 Power Pins

It is recommended to connect power pins (Pin 12 and 34) to a stable supply voltage with sufficient source current. [Table 2-3](#) shows the current consumption.

Additional filtering capacitors are not required but used to ensure stable supply voltage in a noisy environment.

3.6 Internal Program Pins

PGC_INT (Pin 30) and PGD_INT (Pin 31) are internal program pins used during manufacturing. For normal operation, these pins can be left unconnected.

The normal firmware upgrade method is through the internal bootloader of the module via the UART. The method is documented in the *“RN2483 LoRa® Technology Module Command Reference User’s Guide”* (DS40001784).

However, for backup firmware update purposes the user can place a 6-pin ICSP header on their host PCB with PGC_INT (Pin 30), PGD_INT (Pin 31), $\overline{\text{RESET}}$ (Pin 32), power and ground.

During High Voltage In-Circuit Serial Programming mode, the $\overline{\text{RESET}}$ pin is driven with high-voltage (9V), therefore protection may be necessary for sensitive devices.

<p>Note: Only official Microchip Technology firmware released for the RN2483 module shall be used to maintain FCC and IC certification.</p>
--

4.0 PHYSICAL DIMENSIONS

Figure 4-1 and Figure 4-2 illustrate the physical dimensions and the recommended PCB layout for the RN2483 module.

FIGURE 4-1: RN2483 PHYSICAL DIMENSIONS

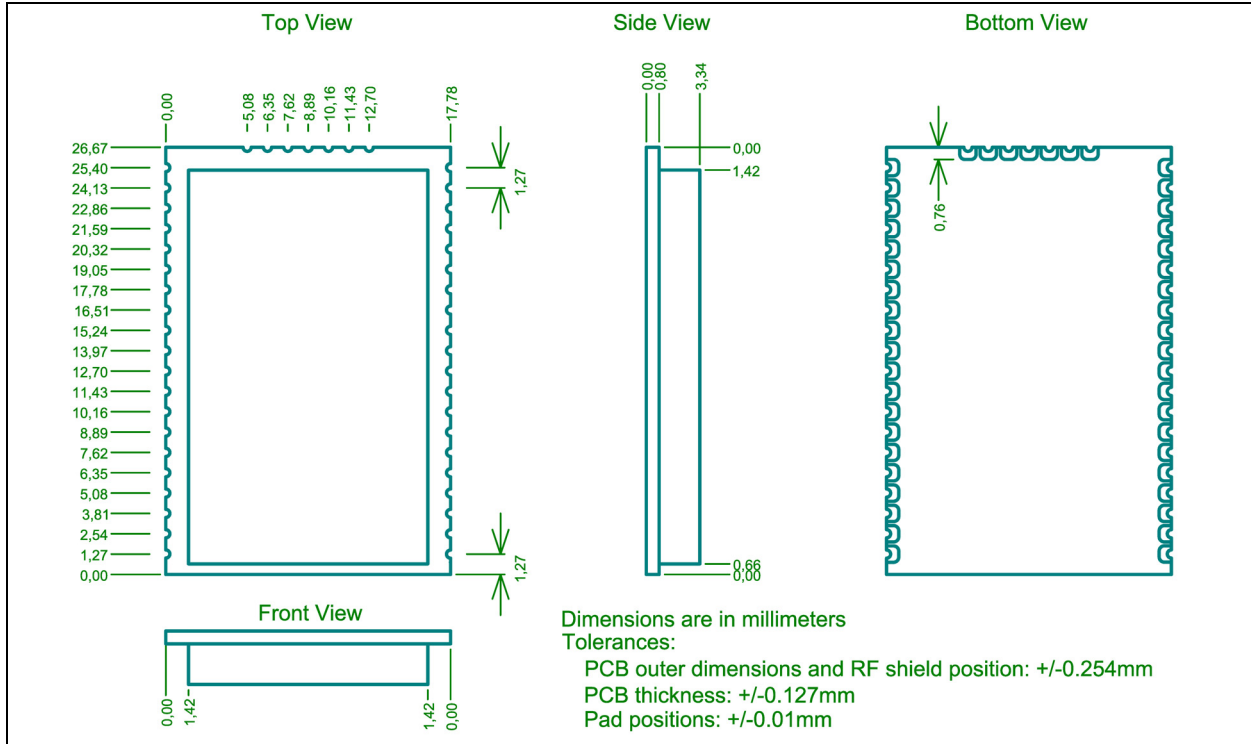
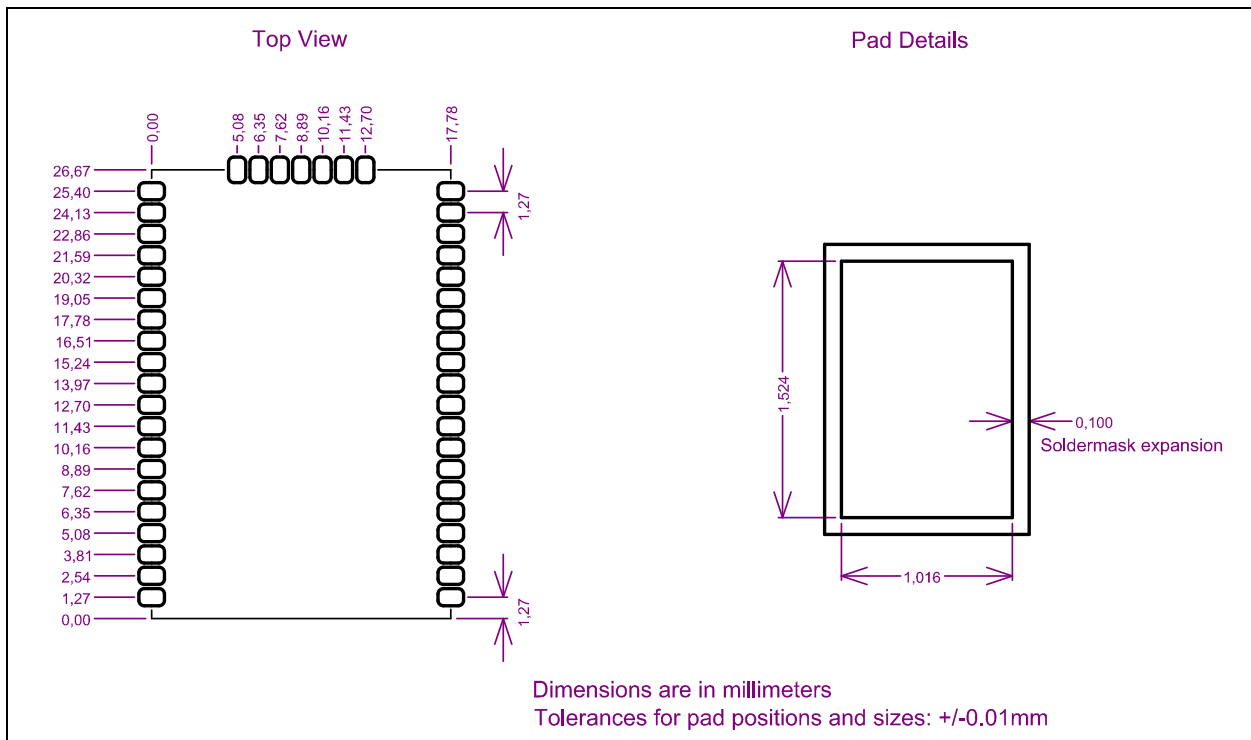

FIGURE 4-2: RECOMMENDED PCB FOOTPRINT



RN2483

5.0 APPLICATION INFORMATION

5.1 RF Trace Layout Design

The RN2483 modular transmitter is certified with a PCB edge SMA connector and micro-strip trace layout as shown in Figure 5-1 and Figure 5-2. The two RF paths

are axisymmetric with the same linear dimensions. The host PCB can follow these trace design to maintain compliance under the modular grant (FCC) and certificate (IC). Gerber files are available on the RN2483 product web page at www.microchip.com/RN2483.

FIGURE 5-1: RF TRACE ROUTING (TOP LAYER)

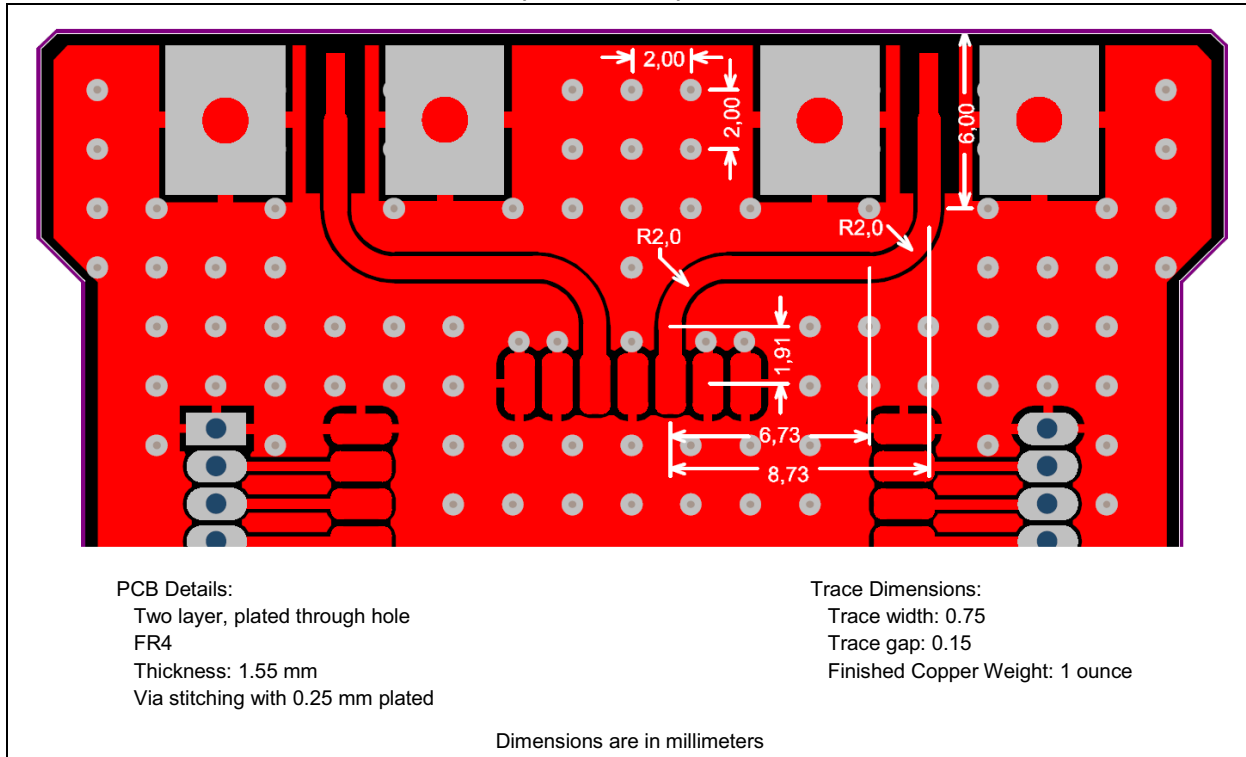
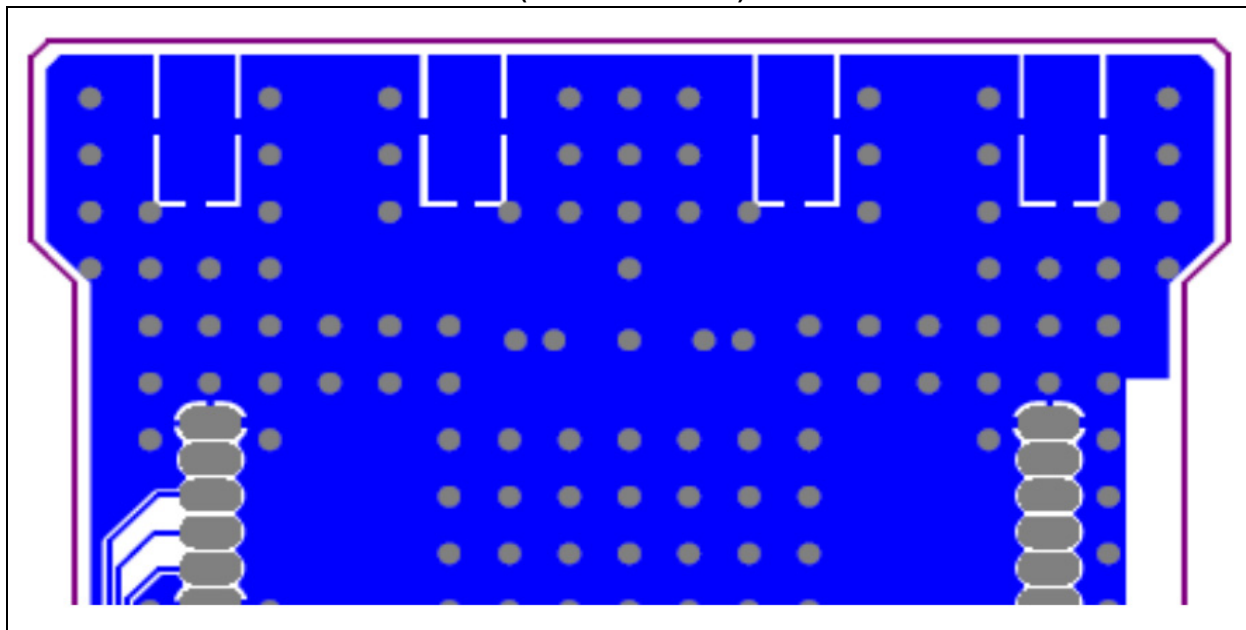

FIGURE 5-2: RF TRACE ROUTING (BOTTOM LAYER)



6.0 REGULATORY APPROVAL

This section outlines the regulatory information for the RN2483 module for Europe.

6.1 Europe

The RN2483 module is an R&TTE Directive assessed radio module that is CE marked and has been manufactured and tested with the intention of being integrated into a final product.

The RN2483 module has been tested to R&TTE Directive 1999/5/EC Essential Requirements for Health and Safety (Article 3.1a), Electromagnetic Compatibility (EMC) (Article 3.1b), and Radio (Article 3.2) and are summarized in [Table 6-1: European Compliance Testing](#). A Notified Body Opinion has also been issued. All test reports are available on the product web page at <http://www.microchip.com>.

The R&TTE Compliance Association provides guidance on modular devices in document **Technical Guidance Note 01** available at http://www.rteca.com/html/download_area.htm.

Note: To maintain conformance to the testing listed in [Table 6-1: European Compliance Testing](#), the module shall be installed in accordance with the installation instructions in this data sheet and shall not be modified. When integrating a radio module into a completed product the integrator becomes the manufacturer of the final product and is therefore responsible for demonstrating compliance of the final product with the essential requirements of the R&TTE Directive.

6.1.1 LABELING AND USER INFORMATION REQUIREMENTS

The label on the final product which contains the RN2483 module must follow CE marking requirements. The "R&TTE Compliance Association Technical Guidance Note 01" provides guidance on final product CE marking.

TABLE 6-1: EUROPEAN COMPLIANCE TESTING

Certification	Standards	Article	Laboratory	Report Number	Date
Safety	IEC 60950-1:2005 (2nd Ed: A1:2009)	(3.1a)	TRaC Global Ltd.	TRA-025134-43-00A	2/12/2015
Health	EN 62479	—	TRaC Global Ltd.	TRA-025134-01-47-03A	2/12/2015
EMC	EN 301 489-3 v1.6.1	(3.1b)	TRaC Global Ltd.	TRA-025134-43-00A	2/12/2015
Radio	EN 300 220-2 v2.4.1	(3.2)	TRaC Global Ltd.	TRA-025134-01-47-00A (433 MHz) TRA-025134-01-47-01A(868MHz)	2/12/2015

6.1.2 EXTERNAL ANTENNA REQUIREMENTS

From R&TTE Compliance Association document **Technical Guidance Note 01**:

Provided the integrator installing an assessed radio module with an integral or specific antenna and installed in conformance with the radio module manufacturer's installation instructions requires no further evaluation under Article 3.2 of the R&TTE Directive and does not require further involvement of an R&TTE Directive Notified Body for the final product (Section 2.2.4).

6.1.3 HELPFUL WEB SITES

A document that can be used as a starting point in understanding the use of Short Range Devices (SRD) in Europe is the European Radio Communications Committee (ERC) Recommendation 70-03 E, which can be downloaded from the European Radio Communications Office (ERO) at: <http://www.ero.dk/>.

Additional helpful web sites are:

- Radio and Telecommunications Terminal Equipment (R&TTE): http://ec.europa.eu/enterprise/sectors/rtte/regulatory-framework/index_en.htm
- European Conference of Postal and Telecommunications Administrations (CEPT): <http://www.cept.org>
- European Telecommunications Standards Institute (ETSI): <http://www.etsi.org>
- European Radio Communications Office (ERO): <http://www.ero.dk/>
- The Radio and Telecommunications Terminal Equipment Compliance Association (R&TTE CA): <http://www.rteca.com/>

RN2483

NOTES:

APPENDIX A: REVISION HISTORY

Revision A (March 2015)

This is the initial release of this document.

Revision B (December 2015)

This revision includes the following updates:

- Updated Deep Sleep value in [Table 2-3](#)
- Updated Dimensions value in [Table 2-4](#)
- Updated [Figure 4-1](#)
- Updated [Figure 4-2](#)
- Added [Figure 5-2](#)
- Updated information for [Section 5.1 “RF Trace Layout Design”](#).

Revision C (April 2017)

This revision includes the following updates:

- Updated [Figure 1-2](#) and [Figure 3-1](#)
- Updated [Table 1-1](#), [Table 2-2](#), and [Table 2-3](#)
- Added [Table 2-6](#) and [Table 2-7](#)
- Updated [Section 3.4 “RESET Pin”](#)
- Added [Section 3.6 “Internal Program Pins”](#)
- Deleted Section “5.2 Application Schematic”.

RN2483

NOTES:

THE MICROCHIP WEB SITE

Microchip provides online support via our WWW site at www.microchip.com. This web site is used as a means to make files and information easily available to customers. Accessible by using your favorite Internet browser, the web site contains the following information:

- **Product Support** – Data sheets and errata, application notes and sample programs, design resources, user's guides and hardware support documents, latest software releases and archived software
- **General Technical Support** – Frequently Asked Questions (FAQ), technical support requests, online discussion groups, Microchip consultant program member listing
- **Business of Microchip** – Product selector and ordering guides, latest Microchip press releases, listing of seminars and events, listings of Microchip sales offices, distributors and factory representatives

CUSTOMER CHANGE NOTIFICATION SERVICE

Microchip's customer notification service helps keep customers current on Microchip products. Subscribers will receive e-mail notification whenever there are changes, updates, revisions or errata related to a specified product family or development tool of interest.

To register, access the Microchip web site at www.microchip.com. Under "Support", click on "Customer Change Notification" and follow the registration instructions.

CUSTOMER SUPPORT

Users of Microchip products can receive assistance through several channels:

- Distributor or Representative
- Local Sales Office
- Field Application Engineer (FAE)
- Technical Support

Customers should contact their distributor, representative or Field Application Engineer (FAE) for support. Local sales offices are also available to help customers. A listing of sales offices and locations is included in the back of this document.

Technical support is available through the web site at: <http://microchip.com/support>

RN2483

NOTES:

PRODUCT IDENTIFICATION SYSTEM

To order or obtain information, e.g., on pricing or delivery, refer to the factory or the listed sales office.

<u>PART NO.</u>				
Device	Temperature Range	Package	Firmware Revision Number	
Device:	RN2483:	Low-Power Long Range LoRa® Technology Transceiver module		
Temperature Range:	I	=	-40°C to +85°C (Industrial)	
Package:	RM	=	Radio Module	

Examples:
RN2483A-I/RM: Industrial temperature

RN2483

NOTES:

Note the following details of the code protection feature on Microchip devices:

- Microchip products meet the specification contained in their particular Microchip Data Sheet.
- Microchip believes that its family of products is one of the most secure families of its kind on the market today, when used in the intended manner and under normal conditions.
- There are dishonest and possibly illegal methods used to breach the code protection feature. All of these methods, to our knowledge, require using the Microchip products in a manner outside the operating specifications contained in Microchip's Data Sheets. Most likely, the person doing so is engaged in theft of intellectual property.
- Microchip is willing to work with the customer who is concerned about the integrity of their code.
- Neither Microchip nor any other semiconductor manufacturer can guarantee the security of their code. Code protection does not mean that we are guaranteeing the product as “unbreakable.”

Code protection is constantly evolving. We at Microchip are committed to continuously improving the code protection features of our products. Attempts to break Microchip's code protection feature may be a violation of the Digital Millennium Copyright Act. If such acts allow unauthorized access to your software or other copyrighted work, you may have a right to sue for relief under that Act.

Information contained in this publication regarding device applications and the like is provided only for your convenience and may be superseded by updates. It is your responsibility to ensure that your application meets with your specifications. MICROCHIP MAKES NO REPRESENTATIONS OR WARRANTIES OF ANY KIND WHETHER EXPRESS OR IMPLIED, WRITTEN OR ORAL, STATUTORY OR OTHERWISE, RELATED TO THE INFORMATION, INCLUDING BUT NOT LIMITED TO ITS CONDITION, QUALITY, PERFORMANCE, MERCHANTABILITY OR FITNESS FOR PURPOSE. Microchip disclaims all liability arising from this information and its use. Use of Microchip devices in life support and/or safety applications is entirely at the buyer's risk, and the buyer agrees to defend, indemnify and hold harmless Microchip from any and all damages, claims, suits, or expenses resulting from such use. No licenses are conveyed, implicitly or otherwise, under any Microchip intellectual property rights unless otherwise stated.

Microchip received ISO/TS-16949:2009 certification for its worldwide headquarters, design and wafer fabrication facilities in Chandler and Tempe, Arizona; Gresham, Oregon and design centers in California and India. The Company's quality system processes and procedures are for its PIC® MCUs and dsPIC® DSCs, KEELOQ® code hopping devices, Serial EEPROMs, microperipherals, nonvolatile memory and analog products. In addition, Microchip's quality system for the design and manufacture of development systems is ISO 9001:2000 certified.

**QUALITY MANAGEMENT SYSTEM
CERTIFIED BY DNV
= ISO/TS 16949 =**

Trademarks

The Microchip name and logo, the Microchip logo, AnyRate, AVR, AVR logo, AVR Freaks, BeaconThings, BitCloud, CryptoMemory, CryptoRF, dsPIC, FlashFlex, flexPWR, Heldo, JukeBlox, KEELOQ, KEELOQ logo, Klear, LANCheck, LINK MD, maXStylus, maXTouch, MediaLB, megaAVR, MOST, MOST logo, MPLAB, OptoLyzer, PIC, picoPower, PICSTART, PIC32 logo, Prochip Designer, QTouch, RightTouch, SAM-BA, SpyNIC, SST, SST Logo, SuperFlash, tinyAVR, UNI/O, and XMEGA are registered trademarks of Microchip Technology Incorporated in the U.S.A. and other countries.

ClockWorks, The Embedded Control Solutions Company, EtherSynch, Hyper Speed Control, HyperLight Load, IntelliMOS, mTouch, Precision Edge, and Quiet-Wire are registered trademarks of Microchip Technology Incorporated in the U.S.A.

Adjacent Key Suppression, AKS, Analog-for-the-Digital Age, Any Capacitor, AnyIn, AnyOut, BodyCom, chipKIT, chipKIT logo, CodeGuard, CryptoAuthentication, CryptoCompanion, CryptoController, dsPICDEM, dsPICDEM.net, Dynamic Average Matching, DAM, ECAN, EtherGREEN, In-Circuit Serial Programming, ICSP, Inter-Chip Connectivity, JitterBlocker, KlearNet, KlearNet logo, Mindi, MiWi, motorBench, MPASM, MPF, MPLAB Certified logo, MPLIB, MPLINK, MultiTRAK, NetDetach, Omniscient Code Generation, PICDEM, PICDEM.net, PICKit, PICtail, PureSilicon, QMatrix, RightTouch logo, REAL ICE, Ripple Blocker, SAM-ICE, Serial Quad I/O, SMART-I.S., SQI, SuperSwitcher, SuperSwitcher II, Total Endurance, TSHARC, USBCheck, VariSense, ViewSpan, WiperLock, Wireless DNA, and ZENA are trademarks of Microchip Technology Incorporated in the U.S.A. and other countries.

SQTP is a service mark of Microchip Technology Incorporated in the U.S.A.

Silicon Storage Technology is a registered trademark of Microchip Technology Inc. in other countries.

GestIC is a registered trademark of Microchip Technology Germany II GmbH & Co. KG, a subsidiary of Microchip Technology Inc., in other countries.

All other trademarks mentioned herein are property of their respective companies.

© 2017, Microchip Technology Incorporated, All Rights Reserved.
ISBN: 978-1-5224-1667-8



MICROCHIP

Worldwide Sales and Service

AMERICAS

Corporate Office
2355 West Chandler Blvd.
Chandler, AZ 85224-6199
Tel: 480-792-7200
Fax: 480-792-7277
Technical Support:
<http://www.microchip.com/support>
Web Address:
www.microchip.com

Atlanta
Duluth, GA
Tel: 678-957-9614
Fax: 678-957-1455

Austin, TX
Tel: 512-257-3370

Boston
Westborough, MA
Tel: 774-760-0087
Fax: 774-760-0088

Chicago
Itasca, IL
Tel: 630-285-0071
Fax: 630-285-0075

Dallas
Addison, TX
Tel: 972-818-7423
Fax: 972-818-2924

Detroit
Novi, MI
Tel: 248-848-4000

Houston, TX
Tel: 281-894-5983

Indianapolis
Noblesville, IN
Tel: 317-773-8323
Fax: 317-773-5453
Tel: 317-536-2380

Los Angeles
Mission Viejo, CA
Tel: 949-462-9523
Fax: 949-462-9608
Tel: 951-273-7800

Raleigh, NC
Tel: 919-844-7510

New York, NY
Tel: 631-435-6000

San Jose, CA
Tel: 408-735-9110
Tel: 408-436-4270

Canada - Toronto
Tel: 905-695-1980
Fax: 905-695-2078

ASIA/PACIFIC

Asia Pacific Office
Suites 3707-14, 37th Floor
Tower 6, The Gateway
Harbour City, Kowloon

Hong Kong
Tel: 852-2943-5100
Fax: 852-2401-3431

Australia - Sydney
Tel: 61-2-9868-6733
Fax: 61-2-9868-6755

China - Beijing
Tel: 86-10-8569-7000
Fax: 86-10-8528-2104

China - Chengdu
Tel: 86-28-8665-5511
Fax: 86-28-8665-7889

China - Chongqing
Tel: 86-23-8980-9588
Fax: 86-23-8980-9500

China - Dongguan
Tel: 86-769-8702-9880

China - Guangzhou
Tel: 86-20-8755-8029

China - Hangzhou
Tel: 86-571-8792-8115
Fax: 86-571-8792-8116

China - Hong Kong SAR
Tel: 852-2943-5100
Fax: 852-2401-3431

China - Nanjing
Tel: 86-25-8473-2460
Fax: 86-25-8473-2470

China - Qingdao
Tel: 86-532-8502-7355
Fax: 86-532-8502-7205

China - Shanghai
Tel: 86-21-3326-8000
Fax: 86-21-3326-8021

China - Shenyang
Tel: 86-24-2334-2829
Fax: 86-24-2334-2393

China - Shenzhen
Tel: 86-755-8864-2200
Fax: 86-755-8203-1760

China - Wuhan
Tel: 86-27-5980-5300
Fax: 86-27-5980-5118

China - Xian
Tel: 86-29-8833-7252
Fax: 86-29-8833-7256

ASIA/PACIFIC

China - Xiamen
Tel: 86-592-2388138
Fax: 86-592-2388130

China - Zhuhai
Tel: 86-756-3210040
Fax: 86-756-3210049

India - Bangalore
Tel: 91-80-3090-4444
Fax: 91-80-3090-4123

India - New Delhi
Tel: 91-11-4160-8631
Fax: 91-11-4160-8632

India - Pune
Tel: 91-20-3019-1500

Japan - Osaka
Tel: 81-6-6152-7160
Fax: 81-6-6152-9310

Japan - Tokyo
Tel: 81-3-6880-3770
Fax: 81-3-6880-3771

Korea - Daegu
Tel: 82-53-744-4301
Fax: 82-53-744-4302

Korea - Seoul
Tel: 82-2-554-7200
Fax: 82-2-558-5932 or
82-2-558-5934

Malaysia - Kuala Lumpur
Tel: 60-3-6201-9857
Fax: 60-3-6201-9859

Malaysia - Penang
Tel: 60-4-227-8870
Fax: 60-4-227-4068

Philippines - Manila
Tel: 63-2-634-9065
Fax: 63-2-634-9069

Singapore
Tel: 65-6334-8870
Fax: 65-6334-8850

Taiwan - Hsin Chu
Tel: 886-3-5778-366
Fax: 886-3-5770-955

Taiwan - Kaohsiung
Tel: 886-7-213-7830

Taiwan - Taipei
Tel: 886-2-2508-8600
Fax: 886-2-2508-0102

Thailand - Bangkok
Tel: 66-2-694-1351
Fax: 66-2-694-1350

EUROPE

Austria - Wels
Tel: 43-7242-2244-39
Fax: 43-7242-2244-393

Denmark - Copenhagen
Tel: 45-4450-2828
Fax: 45-4485-2829

Finland - Espoo
Tel: 358-9-4520-820

France - Paris
Tel: 33-1-69-53-63-20
Fax: 33-1-69-30-90-79

France - Saint Cloud
Tel: 33-1-30-60-70-00

Germany - Garching
Tel: 49-8931-9700

Germany - Haan
Tel: 49-2129-3766400

Germany - Heilbronn
Tel: 49-7131-67-3636

Germany - Karlsruhe
Tel: 49-721-625370

Germany - Munich
Tel: 49-89-627-144-0
Fax: 49-89-627-144-44

Germany - Rosenheim
Tel: 49-8031-354-560

Israel - Ra'anana
Tel: 972-9-744-7705

Italy - Milan
Tel: 39-0331-742611
Fax: 39-0331-466781

Italy - Padova
Tel: 39-049-7625286

Netherlands - Drunen
Tel: 31-416-690399
Fax: 31-416-690340

Norway - Trondheim
Tel: 47-7289-7561

Poland - Warsaw
Tel: 48-22-3325737

Romania - Bucharest
Tel: 40-21-407-87-50

Spain - Madrid
Tel: 34-91-708-08-90
Fax: 34-91-708-08-91

Sweden - Gothenberg
Tel: 46-31-704-60-40

Sweden - Stockholm
Tel: 46-8-5090-4654

UK - Wokingham
Tel: 44-118-921-5800
Fax: 44-118-921-5820