

DSU-FR EMULATOR
F²MC-16FX EXPANSION TRACE BOARD
MB2198-590-E
OPERATION MANUAL

PREFACE

Thank you for purchasing the DSU-FR*¹ emulator F²MC*²-16FX expansion trace board (model number: MB2198-590-E)*³.

This product is used to connect a Fujitsu F²MC-16FX family microcontroller MB96V300 (BGA-416P) to a DSU-FR emulator (model number: MB2198-01)*⁴ and DSU-FR emulator F²MC-16FX BGA-416P adapter (model number: MB2198-500)*⁵.

This document describes how to handle the DSU-FR emulator F²MC-16FX expansion trace board.

Be sure to read this document before using the product.

For details on the mass production MCUs and evaluation MCUs supported by this product, consult with sales or support representative.

*1 : FR, the abbreviation of FUJITSU RISC controller, is a line of products of FUJITSU Limited.

*2 : F²MC is the abbreviation of FUJITSU Flexible Microcontroller.

*3 : Referred to as the trace board in this manual.

*4 : Referred to as the emulator in this manual.

*5 : Referred to as the adapter in this manual.

■ Safe use of this Product

This manual contains important information regarding how to use this product safely. Be sure to read this manual before using the adapter, and to follow the directions given in this manual in order to use the product correctly.

In particular, thoroughly read the "Safety Precautions" at the start of this manual and perform a full safety check before using this product.

After reading the manual, keep it handy for future reference.

■ Warranties and Liability

The specifications of the adapter are subject to change without notice.

Note that Fujitsu shall accept no responsibility for any consequences arising either directly or indirectly from the use of this product.

■ Product Operating Environment

Use the product at an operating temperature of between 5 °C and 35 °C and at an operating humidity of between 20% to 80%. Use the product in an environment that is free of condensation and avoid high temperature or humidity.

This product consists of a printed circuit board unit without casing with all electronic components exposed.

Accordingly, do not place other objects on top of the circuit board and do not allow the metal parts of the unit to come into contact with people or materials that may include static electricity. Similarly, keep any objects that are flammable, likely to cause a short circuit, or cause any other such problem well away from the unit when the power to the unit is turned on.

Use the product as horizontal as possible and avoid operating it at a place exposed to strong vibration, dust, or explosive gas.

If the unit is used in an environment that does not satisfy the above guidelines, there is a risk of unexpected damage to property or injury to the user or other people in the vicinity.

You should also keep the packaging materials used for shipping the product. These are useful if the product needs to be re-shipped again, for example, if it becomes faulty and needs to be repaired.

■ Related Manuals

Refer to the following manuals in conjunction with this manual.

- DSU-FR EMULATOR MB2198-01 HARDWARE MANUAL
- DSU-FR EMULATOR BGA-416P ADAPTER MB2198-500 OPERATION MANUAL
- DSU-FR EMULATOR QFP-100P HEADER TYPE3 MB2198-501 OPERATION MANUAL

■ **European RoHS compliance**

Products with a -E suffix on the part number are European RoHS compliant products.

■ **Notice on this document**

All information included in this document is current as of the date it is issued. Such information is subject to change without any prior notice.

Please confirm the latest relevant information with the sales representatives.

■ **Cautions of the Products Described in this Document**

The following precautions apply to the products described in this manual.

 Warning	<p>Indicates a potentially hazardous situation which could result in death or serious injury and/or a fault in the user's system if not avoided appropriately.</p>
Electric shock, Damage	<p>Before performing any operation described in this manual, turn off all the power supplies to the system. Performing such an operation with the power on may cause an electric shock or device fault.</p>
Electric shock, Damage	<p>Once the product has been turned on, do not touch any metal part of it. Doing so may cause an electric shock or device fault.</p>

 Caution	<p>Indicates the presence of a hazard that may cause a minor or moderate injury, damages to this product or devices connected to it, or may cause to lose software resources and other properties such as data, if the device is not used appropriately.</p>
Cuts, Damage	<p>Before moving the product, be sure to turn off all the power supplies and remove it from the adapters. Watch your step when carrying the product. Do not use the product in an unstable location such as a place exposed to strong vibration or a sloping surface. Doing so may cause the product to fall, resulting in an injury or fault.</p>
Cuts	<p>This product has sharp edges that are left unavoidably exposed. Take care when handling the product to avoid being injured by these sharp edges.</p>
Damage	<p>Do not place anything on the product or expose the product to physical shocks. Do not carry the product after the power has been turned on. Doing so may cause a malfunction due to overloading or shock.</p>
Damage	<p>Since the product contains many electronic components, keep it away from direct sunlight, high temperature, and high humidity to prevent condensation. Do not use or store the product where it is exposed to much dust or a strong magnetic or electric field for an extended period of time. Inappropriate operating or storage environments may cause a fault.</p>
Damage	<p>Use the product within the ranges given in the specifications. Operation over the specified ranges may cause a fault.</p>
Damage	<p>To prevent electrostatic breakdown, do not let your finger or other object come into contact with the metal parts of any of the connectors. Before handling the product, touch a metal object (such as a door knob) to discharge any static electricity from your body.</p>
Damage	<p>When turning the power on or off, follow the relevant procedure as described in this document. Before turning the power on, in particular, be sure to finish making all the required connections. Furthermore, be sure to configure and use the product by following the instructions given in this document. Using the product incorrectly or inappropriately may cause a fault.</p>
Damage	<p>Because the product has no casing, it is recommended that it be stored in the original packaging. Transporting the product may cause a damage or fault. Therefore, keep the packaging materials and use them when re-shipping the product.</p>

- The contents of this document are subject to change without notice.
Customers are advised to consult with sales representatives before ordering.
- The information, such as descriptions of function and application circuit examples, in this document are presented solely for the purpose of reference to show examples of operations and uses of FUJITSU semiconductor device; FUJITSU does not warrant proper operation of the device with respect to use based on such information. When you develop equipment incorporating the device based on such information, you must assume any responsibility arising out of such use of the information. FUJITSU assumes no liability for any damages whatsoever arising out of the use of the information.
- Any information in this document, including descriptions of function and schematic diagrams, shall not be construed as license of the use or exercise of any intellectual property right, such as patent right or copyright, or any other right of FUJITSU or any third party or does FUJITSU warrant non-infringement of any third-party's intellectual property right or other right by using such information. FUJITSU assumes no liability for any infringement of the intellectual property rights or other rights of third parties which would result from the use of information contained herein.
- The products described in this document are designed, developed and manufactured as contemplated for general use, including without limitation, ordinary industrial use, general office use, personal use, and household use, but are not designed, developed and manufactured as contemplated (1) for use accompanying fatal risks or dangers that, unless extremely high safety is secured, could have a serious effect to the public, and could lead directly to death, personal injury, severe physical damage or other loss (i.e., nuclear reaction control in nuclear facility, aircraft flight control, air traffic control, mass transport control, medical life support system, missile launch control in weapon system), or (2) for use requiring extremely high reliability (i.e., submersible repeater and artificial satellite).
Please note that FUJITSU will not be liable against you and/or any third party for any claims or damages arising in connection with above-mentioned uses of the products.
- Any semiconductor devices have an inherent chance of failure. You must protect against injury, damage or loss from such failures by incorporating safety design measures into your facility and equipment such as redundancy, fire protection, and prevention of over-current levels and other abnormal operating conditions.
- Exportation/release of any products described in this document may require necessary procedures in accordance with the regulations of the Foreign Exchange and Foreign Trade Control Law of Japan and/or US export control laws.
- The company names and brand names herein are the trademarks or registered trademarks of their respective owners.

1. Product Overview

■ Overview

This product is an external trace board that provides a maximum capacity of 2 Gbytes (64 bits × 256 Mframe) of external trace functionality. The trace board is used by connecting to the F²MC-16FX BGA-416P adapter (model number: MB2198-500), which connects the DSU-FR Emulator (model number: MB2198-01, referred to as the emulator in this manual) to a user system using a Fujitsu F²MC-16FX family microcontroller. This product is an optional product for the DSU-FR emulator that assists the development of user systems that use a Fujitsu F²MC-16FX family microcontroller.

■ Verifying the Contents of the Package

Check that all of the following components are present in the package before using the trace board.

- Trace board :1
- AC adapter :1
- Locking screws :1 set (2 screws)
- Operation manual (English: this manual) :1
- Operation manual (Japanese) :1

■ Related Products

The optional products shown in Table 1 are available for the adapter. Purchase these separately as needed.

Table 1 Optional Parts

Name	Part number
DSU-FR emulator	MB2198-01
F ² MC-16FX BGA-416P adapter	MB2198-500
F ² MC-16FX QFP-100P header type3	MB2198-501
Evaluation MCU*	MB96V300

* : The evaluation MCU is used connected to the adapter.

Consult with sales or support representative for details on compatible evaluation MCUs.

■ System Configuration

The trace board is used in combination with the emulator, adapter, header board, and other components. These are used connected to the user system.

A schematic of the system configuration of this product is shown in Figure 1.

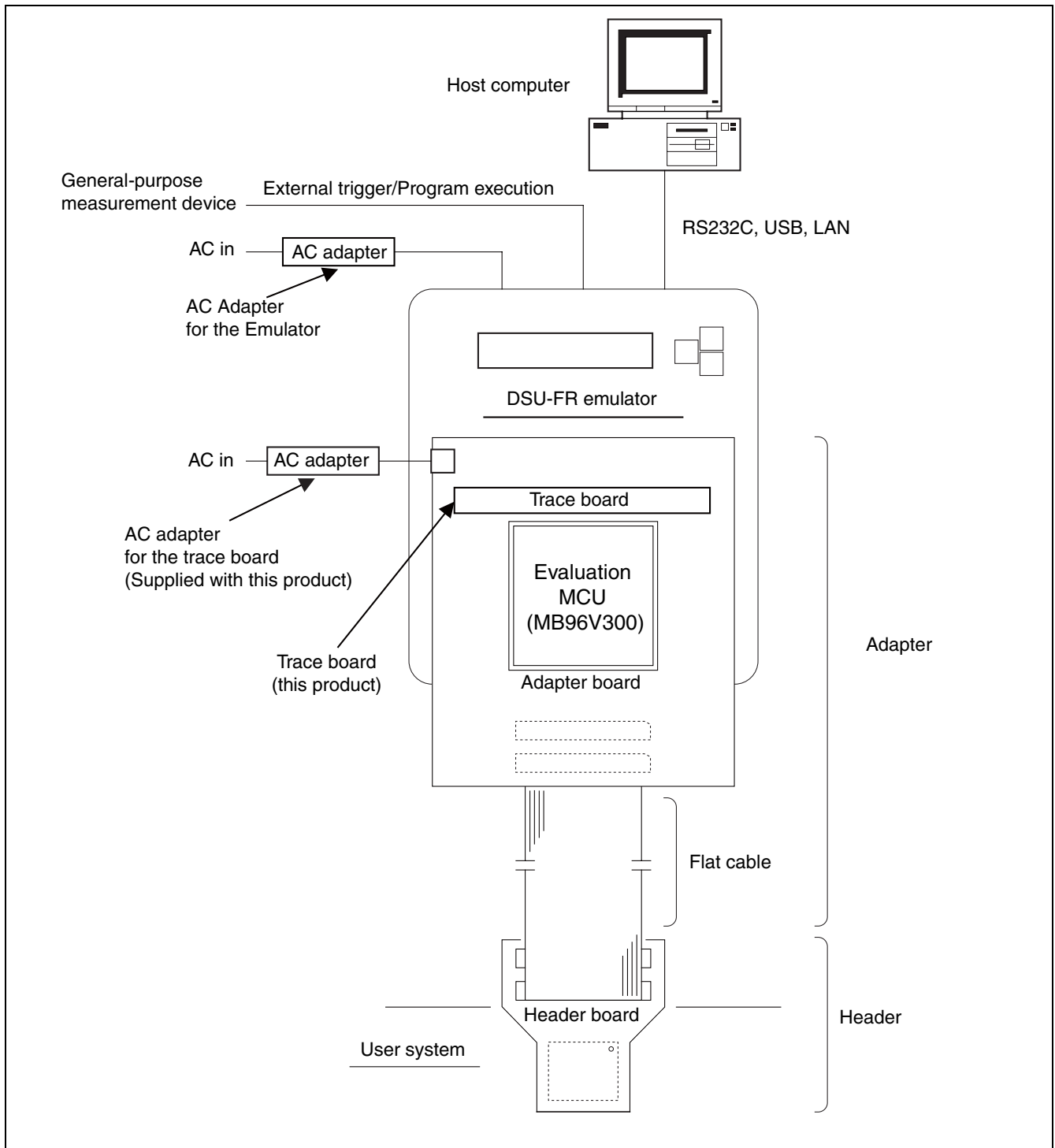

Figure 1 System configuration schematic

A host computer and emulator debugger software need to be purchased separately to use the emulator. See "3. Connection" for details on how to connect the adapter and the header board. See the hardware manual and operation manual of the emulator and adapter for the specifications of these components.

■ External Appearance and Component Names

The external appearance of the adapter board is shown in Figure 2 and the component names are shown in Figure 3.

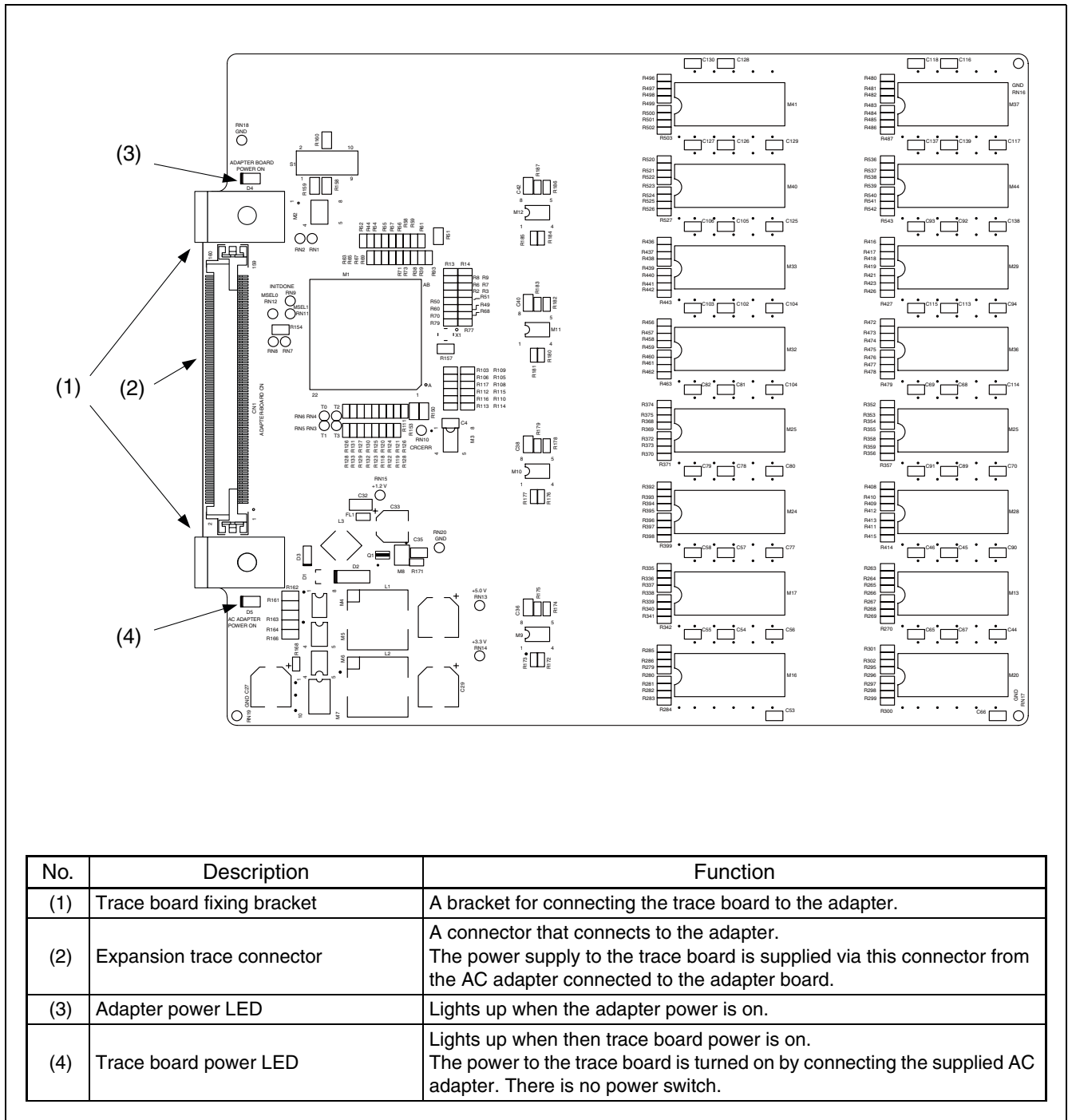

Figure 2 External appearance (component side)

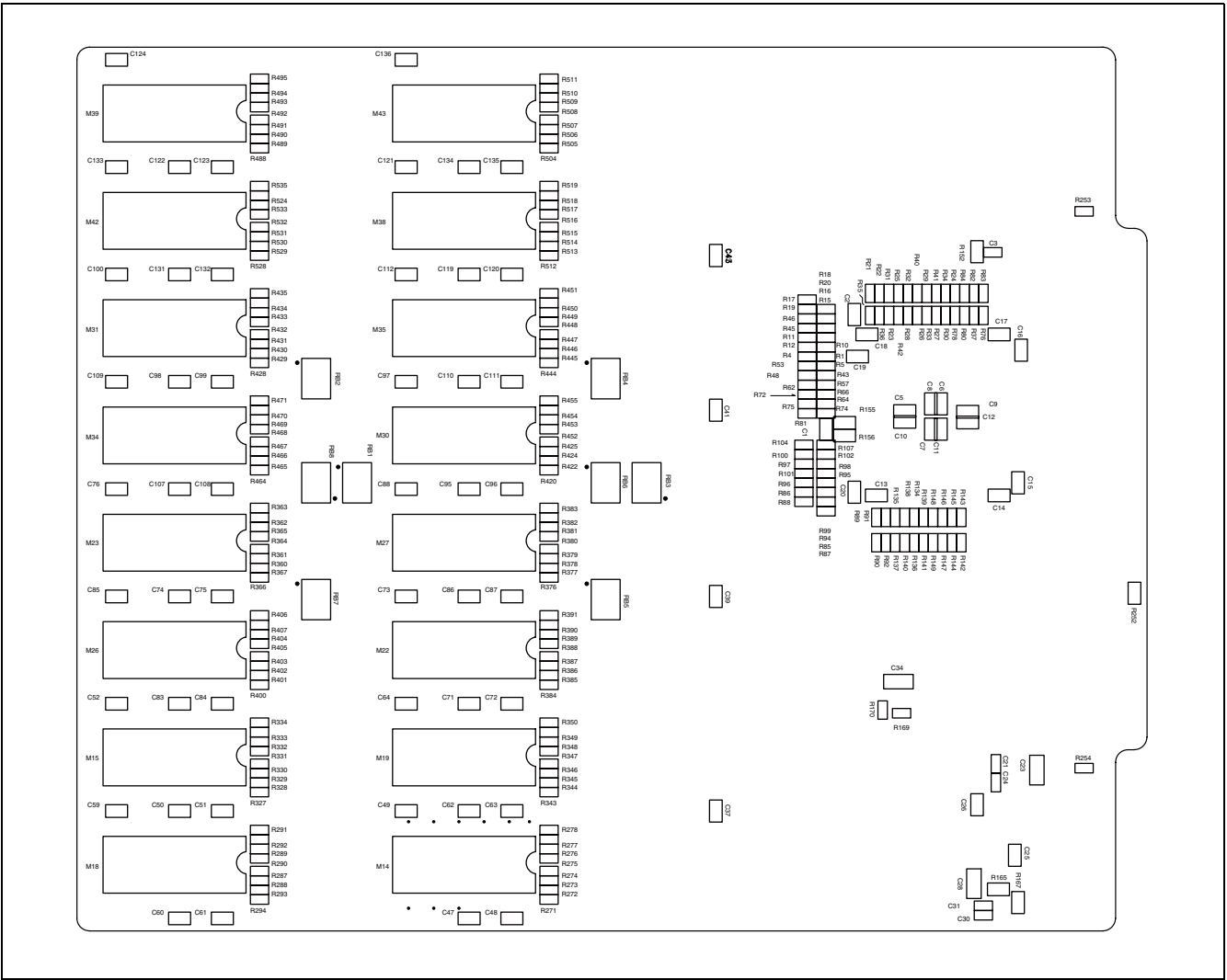

Figure 3 External appearance(solder side)

2. Usage Cautions

Adhere to the following precautions when using the trace board.

■ Cautions

- The basic trace function on the adapter cannot be used when the trace board is connected to the adapter.
- When using the trace board, connect the AC adapter provided with the trace memory to the adapter. See "3. Connection ■ Connecting the AC adapter" for details on how to connect the AC adapter.
- When the trace board is connected to the adapter, fix the two boards together using the locking screws.

3. Connection

■ Connecting the Adapter

See Figure 4 to connect the trace board.

See the operation manual of the F²MC-16FX BGA-416P adapter (model number: MB2198-500) and the F²MC-16FX QFP-100P header type3 (model number: MB2198-501) for details on connecting the adapter and header to the user system.

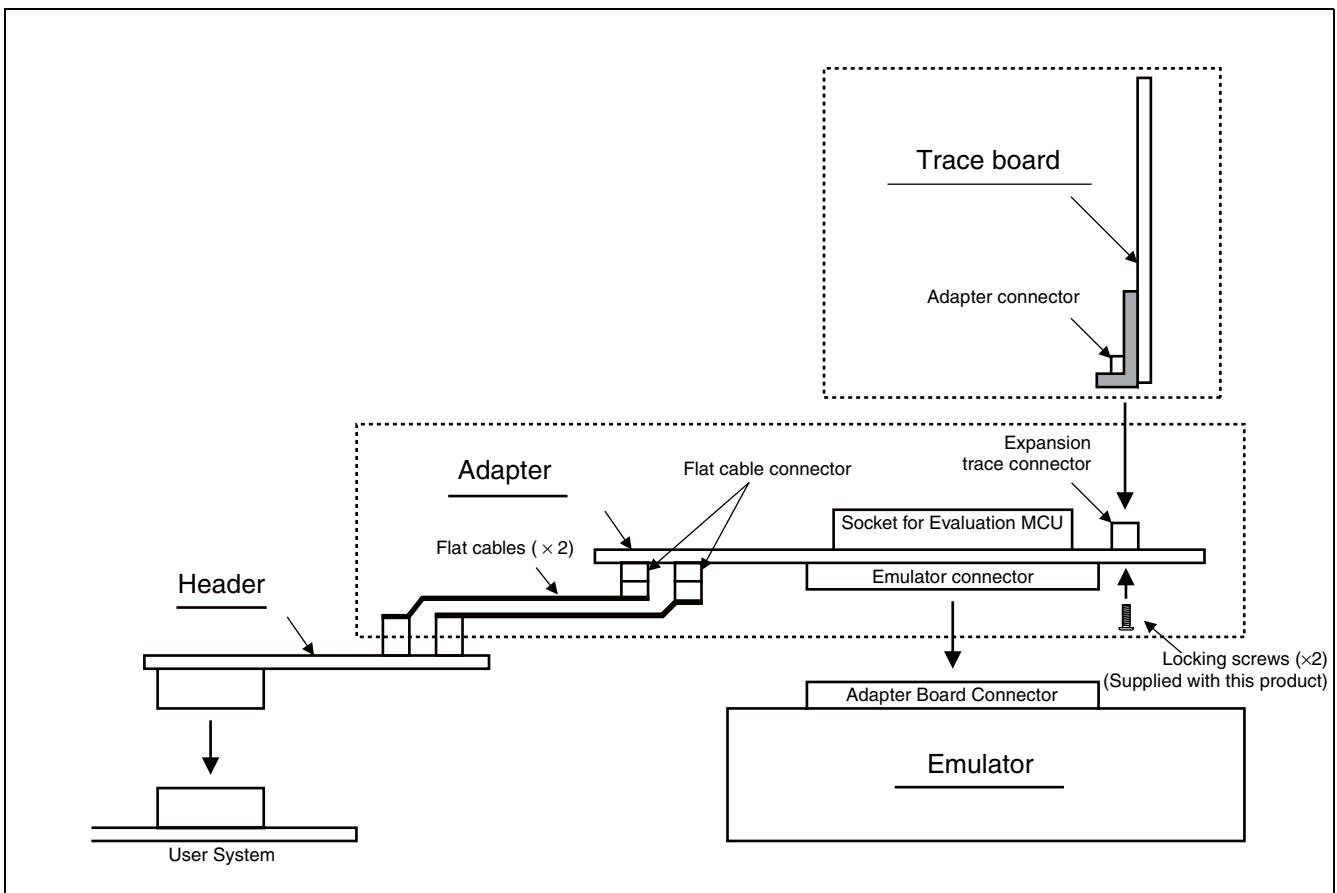

Figure 4 Connecting the trace board

■ Connecting the AC Adapter

See Figure 5 to connect the AC adapter.

See the “F²MC-16FX BGA-416P ADAPTER MB2198-500 OPERATION MANUAL” for the position of the DC jack.

1. Connect the AC cord to the AC adapter.
2. Connect the AC adapter to the adapter.
3. Insert the AC plug into a power outlet.

Note : The power supply to the trace board is supplied by connecting the AC adapter to the adapter. As there is no power switch on the trace board, connect the AC adapter in the correct sequence within the power-on sequence.

See "4 Operating Procedures ■ Power-on Sequence and ■ Power-off Sequence" for details on the power-on sequence.

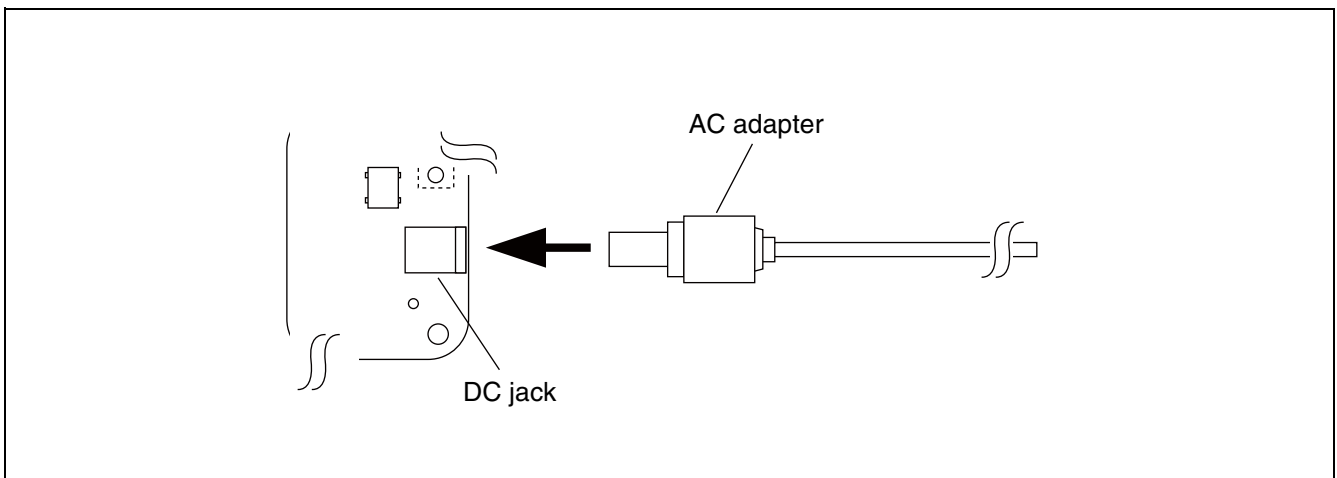

Figure 5 Connecting the AC adapter

4. Operating Procedures

This section describes the power-on and off sequences. Be sure to read this section before turning the power on.

■ Power-on Sequence

To turn the power on, follow the procedure shown in Figure 6 after making all devices connected.

The emulator power can be turned on by pressing down the power switch on the rear of the emulator. The switch then remains in the depressed position.

See the hardware manual of the emulator for details on the position of the power switch.

The power to the adapter is turned on using the power switch on the adapter. See the “F²MC-16FX BGA-416P ADAPTER MB2198-500 OPERATION MANUAL” for the position of the power switch on the adapter.

The emulator needs to be initialized (monitor loading) immediately before the power is turned on to the user system in a factory default state. See the “SOFTUNE Workbench OPERATING MANUAL” for details on the initialization procedure.

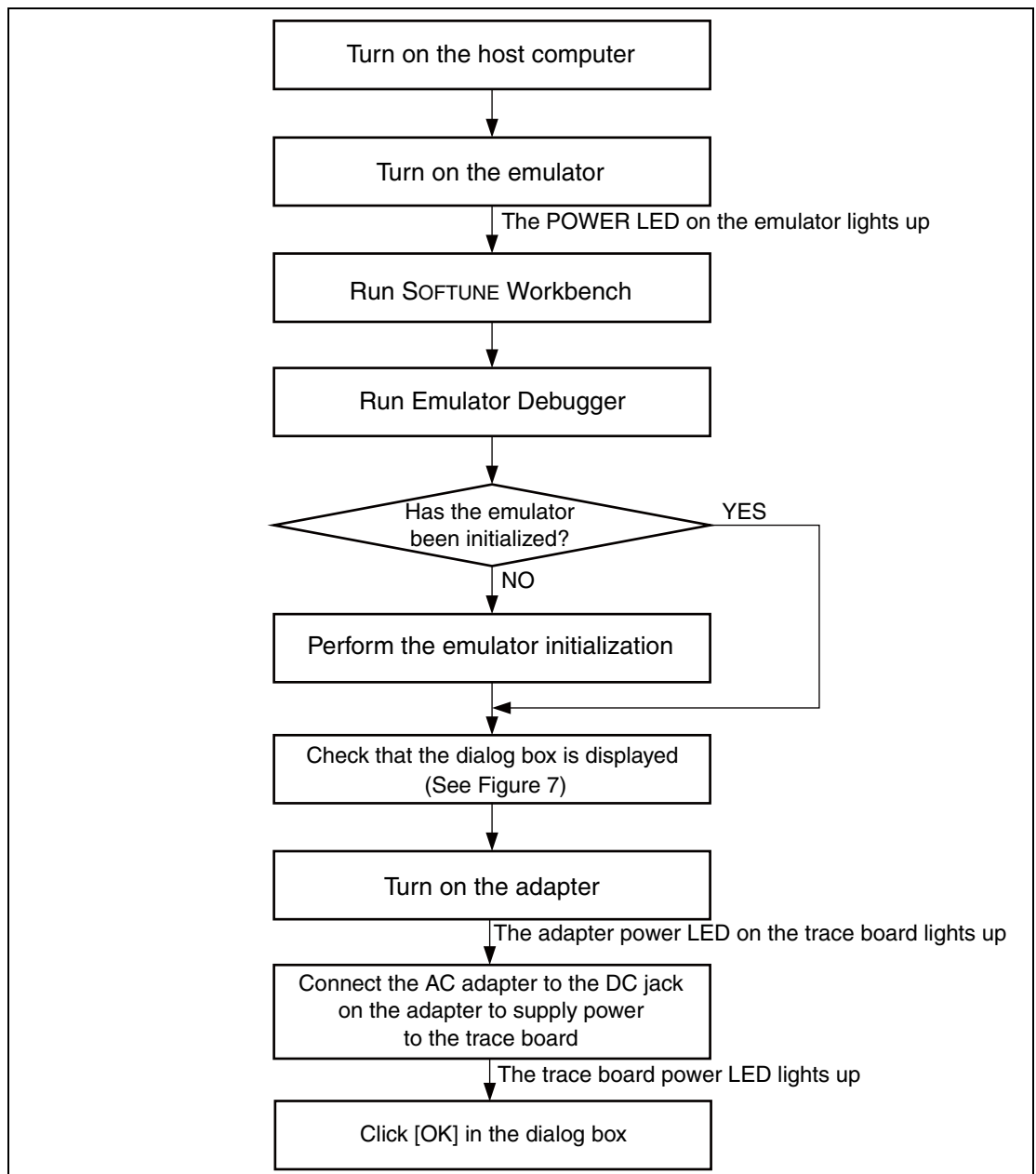

Figure 6 Power-on sequence



Figure 7 Dialog box displayed

Note : When the power is turned on to the user system, the adapter power LED on the trace board and the USER POWER LED on the adapter light up. Additionally, when the AC adapter is connected to the DC jack on the adapter, the Trace Board Power LED on the trace board lights up. If a LED does not light up when the power is turned on, quickly disconnect the power to the entire system, and turn the power on again after resolving the problem by checking such that there are no incorrect connections.

■ Power-off Sequence

Turn the power off by following the procedure shown in Figure 8.

The emulator power can be turned off by pressing down and releasing the power switch on the rear of the emulator. The depressed switch then returns to the off position (the unpressed position).

See the hardware manual of the emulator for details on the position of the power switch.

Turn off the power to the adapter using the power switch on the adapter. See the "F²MC-16FX BGA-416P Adapter MB2198-500 Operation Manual" for the position of the power switch on the adapter.

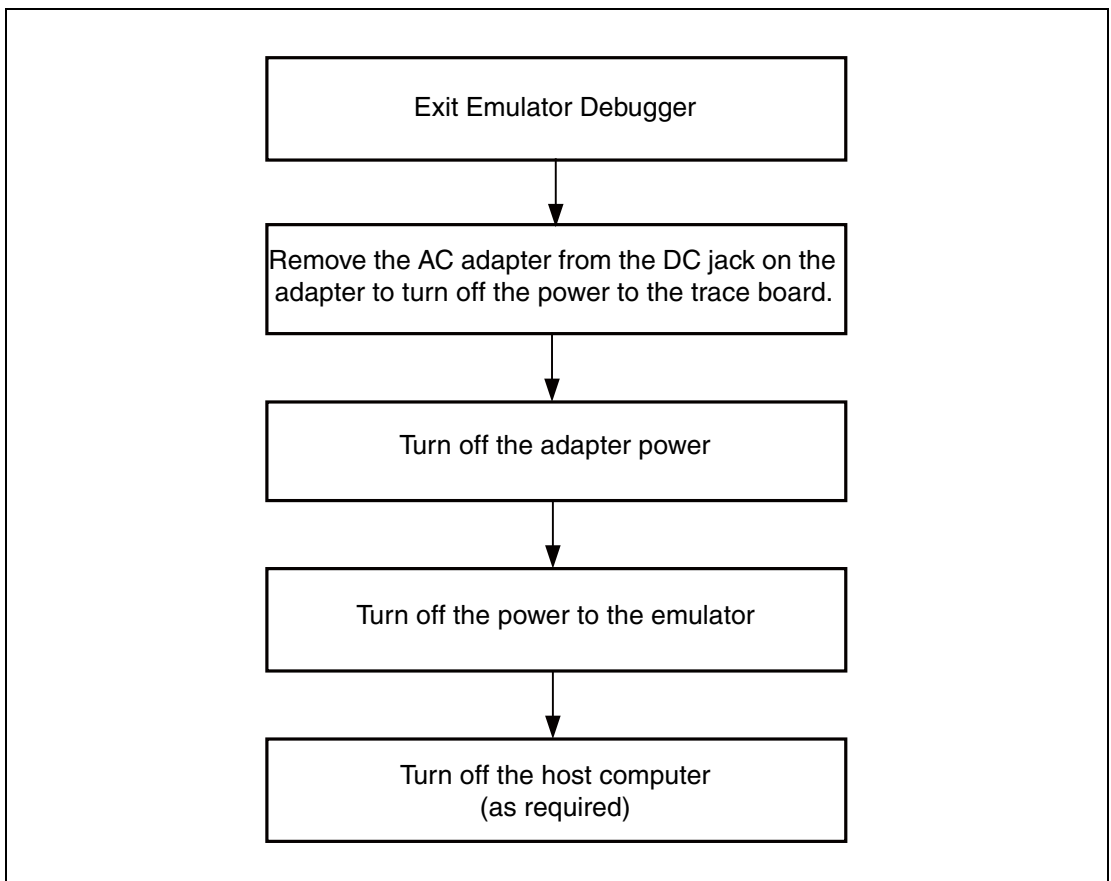

Figure 8 Power-off sequence

5. Specifications

5.1 General Specifications

The general specifications of the trace board are shown in Table 2.

Table 2 General Specifications

Item	Specification	Remarks
Product name	DSU-FR emulator F ² MC-16FX expansion trace board	
Product model	MB2198-590-E	
Memory capacity	2 GB	512Mbit SDRAM × 32
Input power	Maximum: +16V / 2.5A	Supplied by adapter DC jack
Operating voltage	+3.3V: FPGA (I/O), SDRAM	Generates +5V from +16V Generates +3.3V and +1.2V from +5V
	+1.2V: FPGA (internal)	
Operating frequency	Max: 66MHz	
Operating temperature Storage temperature	+5 °C to +35 °C 0 °C to +70 °C	No condensation
Operating humidity Storage humidity	20% to 80% 20% to 80%	No condensation
External dimensions	169.0mm(D) × 139.0mm(W) × 19.0mm(H)	No chassis
Weight	125.0g	No chassis

5.2 Function Specifications

The function specifications of the trace board are shown in Table 3.

Table 3 Trace Board Function Specifications

Item	Description
Trace board function	64bit × 256Mframe (2GB) trace memory function.

The adapter connector specifications are shown in Table 4 and the pin assignment is shown in Table 5.

Table 4 Adapter Connector Specifications

Item	Description
Adapter connector	Model: 8601-160L (Manufactured by KEL). 160-pin right-angle connector

Table 5 Adapter Connector Pin Assignment

Connector pin number	Pin name	Connector pin number	Pin name	Connector pin number	Pin name	Connector pin number	Pin name
1	DC16V	41	TRDYX	81	TDT[30]	121	TDT[62]
2	DC16V	42	TOEX	82	TDT[31]	122	TDT[63]
3	DC16V	43	GND	83	GND	123	GND
4	DC16V	44	GND	84	GND	124	GND
5	DC16V	45	TDT[0]	85	TDT[32]	125	TAD[0]
6	DC16V	46	TDT[1]	86	TDT[33]	126	TAD[1]
7	MNT[0]	47	TDT[2]	87	TDT[34]	127	TAD[2]
8	MNT[1]	48	TDT[3]	88	TDT[35]	128	TAD[3]
9	MNT[2]	49	TDT[4]	89	TDT[36]	129	TAD[4]
10	MNT[3]	50	TDT[5]	90	TDT[37]	130	TAD[5]
11	MNT[4]	51	TDT[6]	91	TDT[38]	131	TAD[6]
12	MNT[5]	52	TDT[7]	92	TDT[39]	132	TAD[7]
13	GND	53	GND	93	GND	133	GND
14	GND	54	GND	94	GND	134	GND
15	MNT[6]	55	TDT[8]	95	TDT[40]	135	TAD[8]
16	MNT[7]	56	TDT[9]	96	TDT[41]	136	TAD[9]
17	MNT[8]	57	TDT[10]	97	TDT[42]	137	TAD[10]
18	MNT[9]	58	TDT[11]	98	TDT[43]	138	TAD[11]
19	MNT[10]	59	TDT[12]	99	TDT[44]	139	TAD[12]
20	MNT[11]	60	TDT[13]	100	TDT[45]	140	TAD[13]
21	MNT[12]	61	TDT[14]	101	TDT[46]	141	TAD[14]
22	MNT[13]	62	TDT[15]	102	TDT[47]	142	TAD[15]
23	GND	63	GND	103	GND	143	GND
24	GND	64	GND	104	GND	144	GND
25	MNT[14]	65	TDT[16]	105	TDT[48]	145	TAD[16]
26	MNT[15]	66	TDT[17]	106	TDT[49]	146	TAD[17]
27	MNT[16]	67	TDT[18]	107	TDT[50]	147	TAD[18]
28	MNT[17]	68	TDT[19]	108	TDT[51]	148	TAD[19]
29	MNT[18]	69	TDT[20]	109	TDT[52]	149	TAD[20]
30	MNT[19]	70	TDT[21]	110	TDT[53]	150	TAD[21]
31	MNT[20]	71	TDT[22]	111	TDT[54]	151	TAD[22]
32	EXTTRC	72	TDT[23]	112	TDT[55]	152	TAD[23]
33	GND	73	GND	113	GND	153	GND
34	GND	74	GND	114	GND	154	GND
35	TCLK	75	TDT[24]	115	TDT[56]	155	TAD[24]
36	EXTTRCX	76	TDT[25]	116	TDT[57]	156	TAD[25]
37	GND	77	TDT[26]	117	TDT[58]	157	TAD[26]
38	TADCSX	78	TDT[27]	118	TDT[59]	158	TAD[27]
39	TWRX	79	TDT[28]	119	TDT[60]	159	VCC
40	TEMUL	80	TDT[29]	120	TDT[61]	160	VCC

5. 3 Expansion Trace Memory AC Specifications

■ DSU-side Trace Memory Write Timing

Figure 9 shows the trace memory write timing as seen from the DSU side.

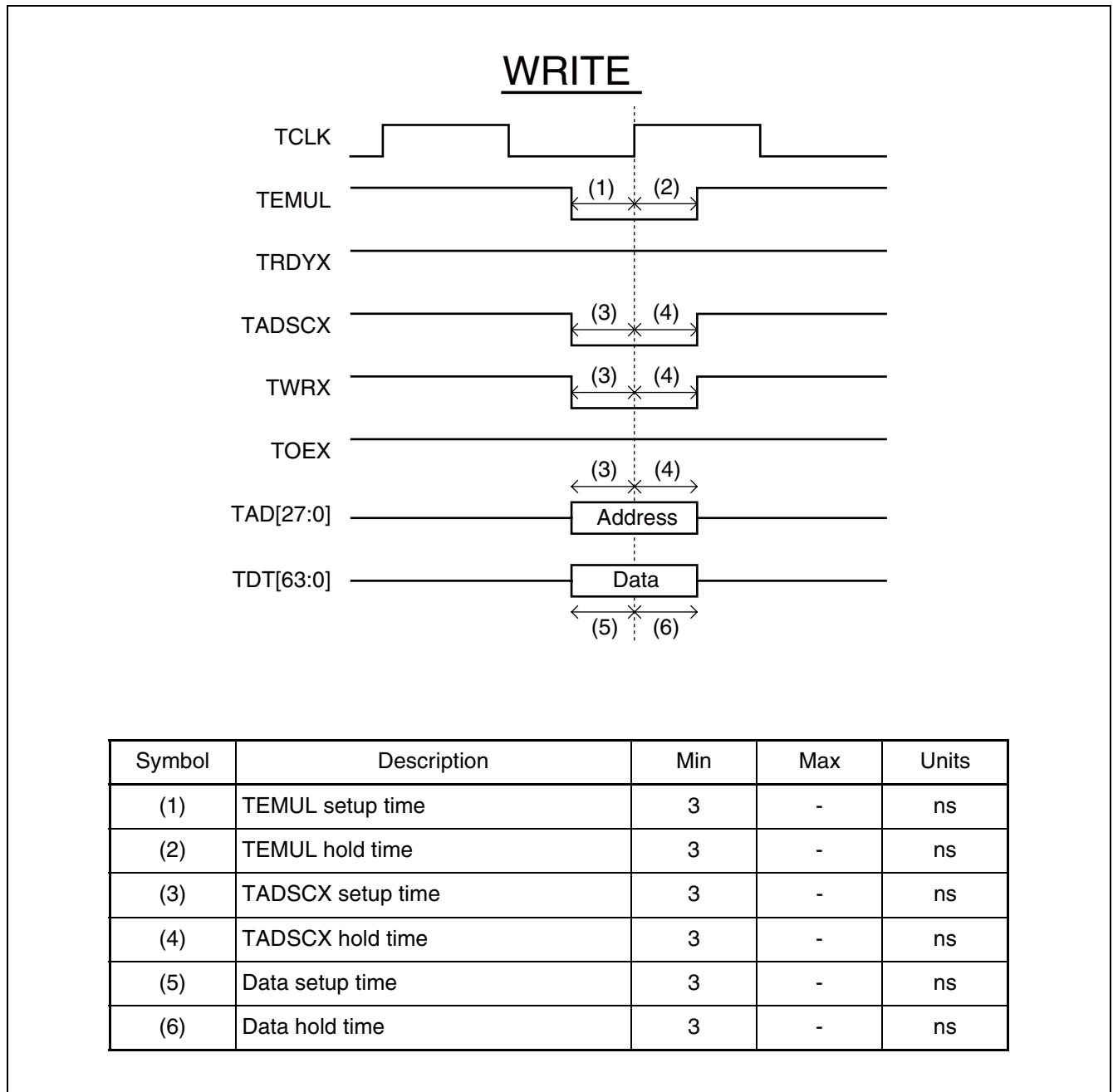

Figure 9 DSU-side trace memory write timing

■ DSU-side Trace Memory Read Timing

Figure 10 shows the trace memory read timing as viewed from the DSU side.
Note that the AC specifications vary depending on the voltage applied to VCC5.

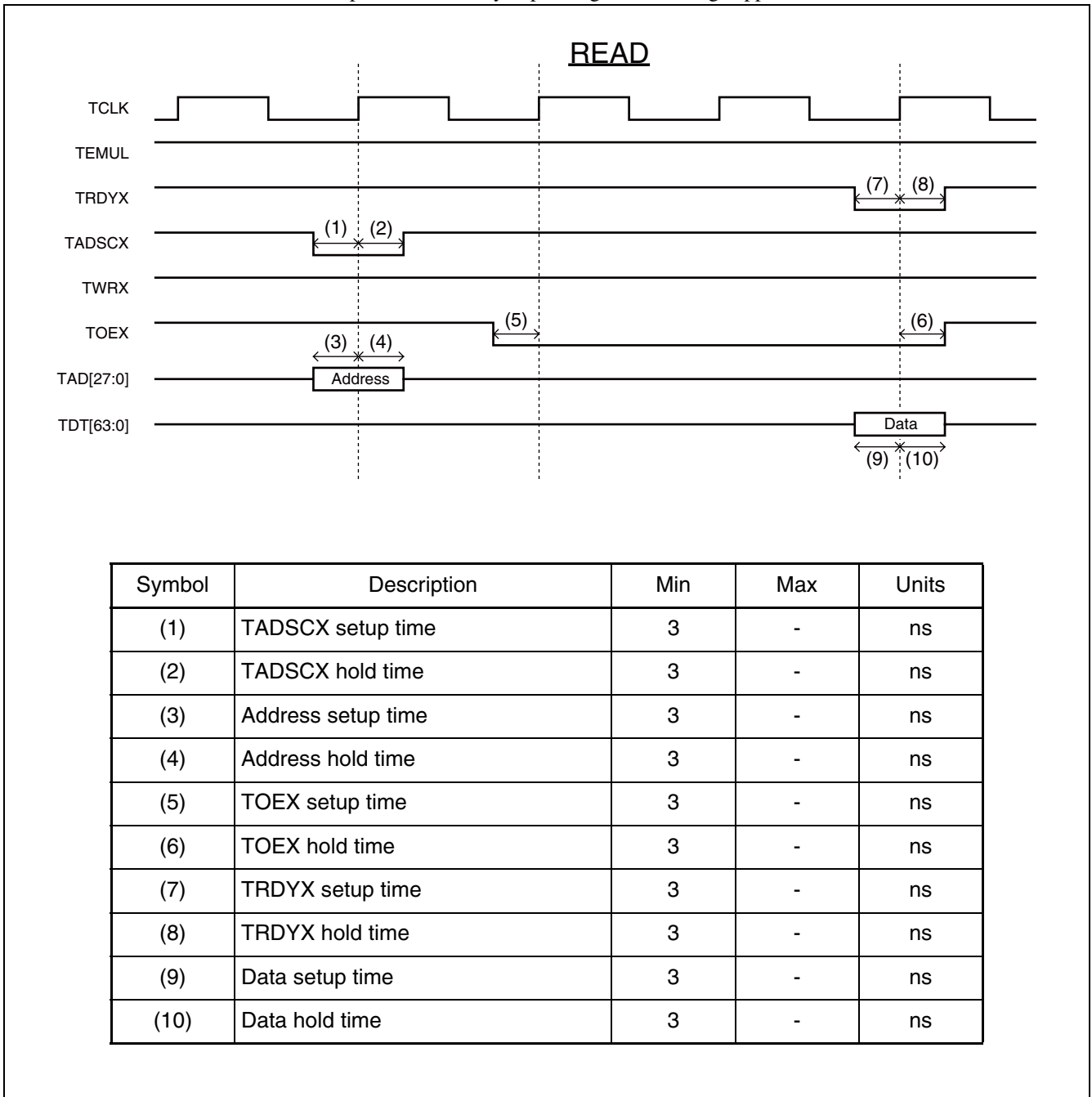

Figure 10 DSU-side trace memory read timing

SS01-71076-1E

FUJITSU SEMICONDUCTOR • SUPPORT SYSTEM

DSU-FR EMULATOR
F²MC-16FX EXPANSION TRACE BOARD
MB2198-590-E
OPERATION MANUAL

February 2008 the first edition

Published **FUJITSU LIMITED** Electronic Devices

Edited Strategic Business Development Dept.

FUJITSU