

# Xinger®

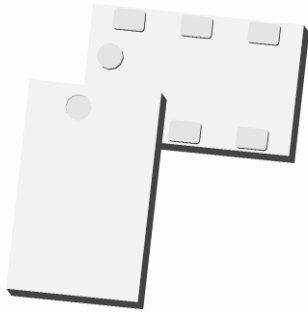

## Ultra Low Profile 0805 10dB Directional Coupler

### Description

The DC2337J5010AHF is a low cost, low profile sub-miniature high performance 20 dB directional coupler in an easy to use RoHS compliant, Halogen Free surface mount package. It is designed for 2300 – 3700MHz applications including: WiFi, WiMAX, LTE2600, Bluetooth and Low Power Radio Gateway applications. The DC2337J5010AHF is ideal for power detection, signal injection and other applications where low insertion loss signal monitoring is required. The DC2337J5010AHF is available on tape and reel for pick and place high volume manufacturing. All of the Xinger components are constructed from ceramic filled PTFE composites which possess excellent electrical and mechanical stability. All parts have been subjected to rigorous qualification testing and units are 100% RF tested.

**Detailed Electrical Specifications:** Specifications subject to change without notice.

Features:	ROOM (25°C)												
	Frequency (MHz)	Mean Coupling (dB)			Insertion loss (dB)		Return Loss (dB)		Directivity (dB)		Frequency Sensitivity (dB)		Power Handling (watts)
		Min	Typ.	Max	Typ.	Max	Typ.	Min	Typ.	Min	Typ.	Max	Max
• 2300 – 3700 MHz	2300 - 2400	10.2	10.7	11.2	0.15	0.22	30.3	20.0	24.4	20.0	0.07	0.08	2
• Mean Coupling 10dB													
• 0.58mm Height Profile													
• Ultra Low Insertion Loss													
• Surface Mountable													
• Tape & Reel	2400 - 2500	10.0	10.5	11.1	0.15	0.22	30.8	20.0	25.2	20.0	0.05	0.07	2
• RoHS Compliant													
• Halogen Free													
• -55°C to 85°C													
	2630 - 2655	9.8	10.4	10.9	0.15	0.22	30.6	20.0	28.0	20.0	0.01	0.02	2
	3300 - 3700	10.2	10.8	11.6	0.21	0.29	22.8	17.4	21.1	16.0	0.50	0.60	2

\*\*Specification based on performance of unit properly installed on microstrip printed circuit boards with 50 Ω nominal impedance.

### Outline Drawing

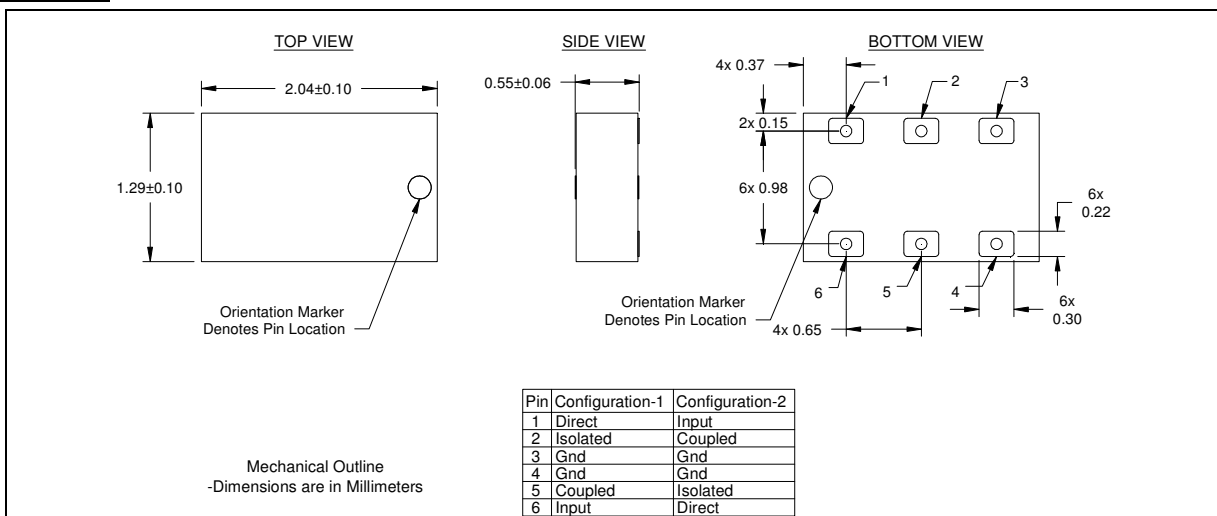

## Typical Performance: 2300 MHz. to 3700 MHz (Configuration 1)

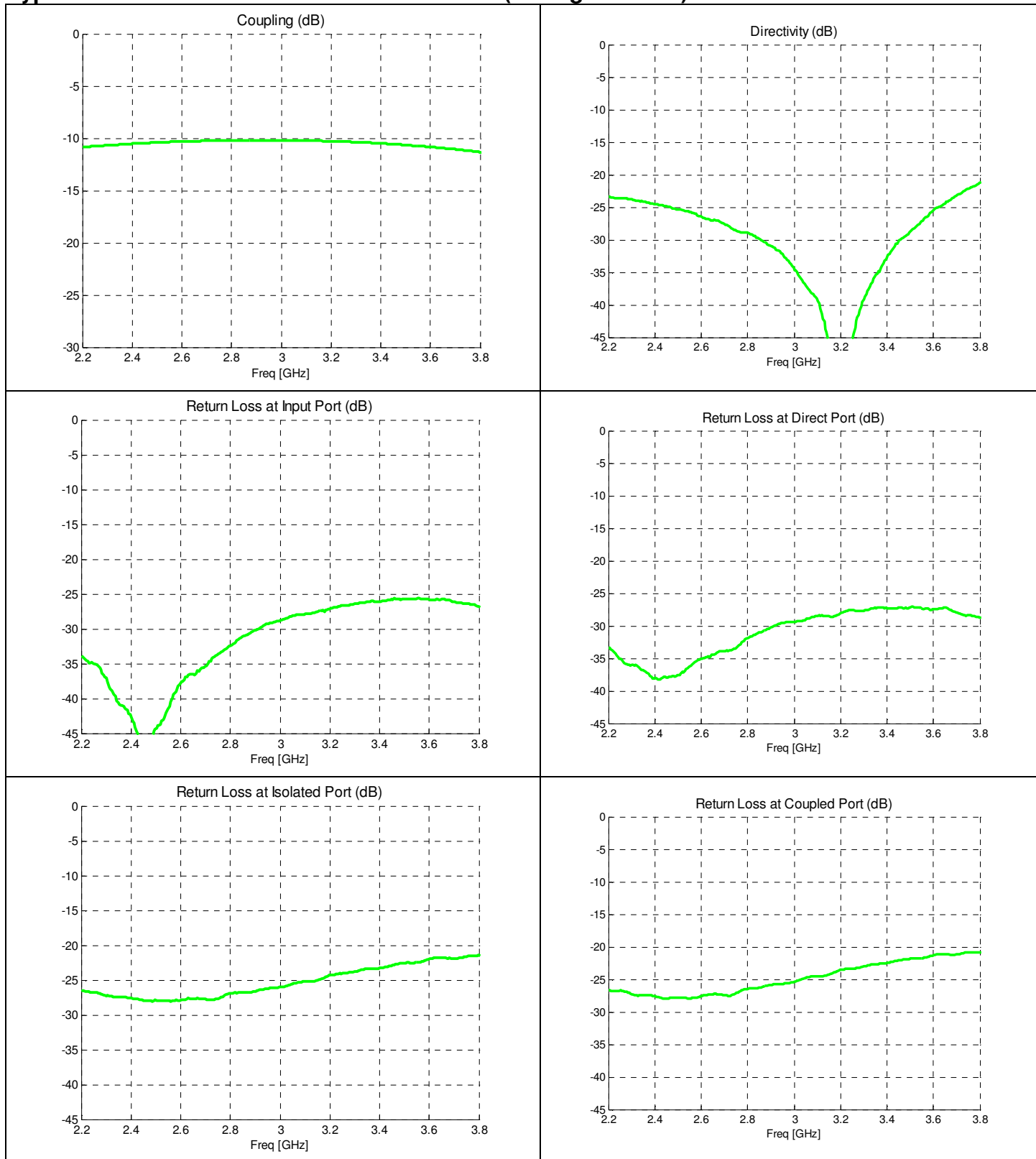

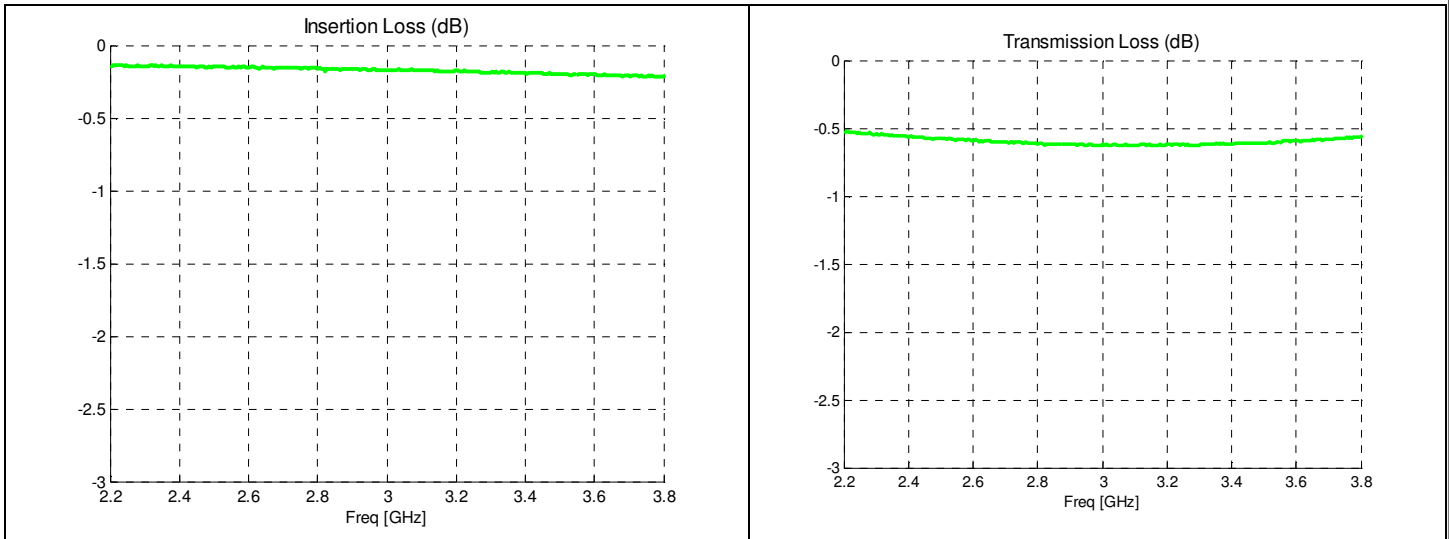

### Wideband Performance: 0 to 8500MHz (Configuration 1)

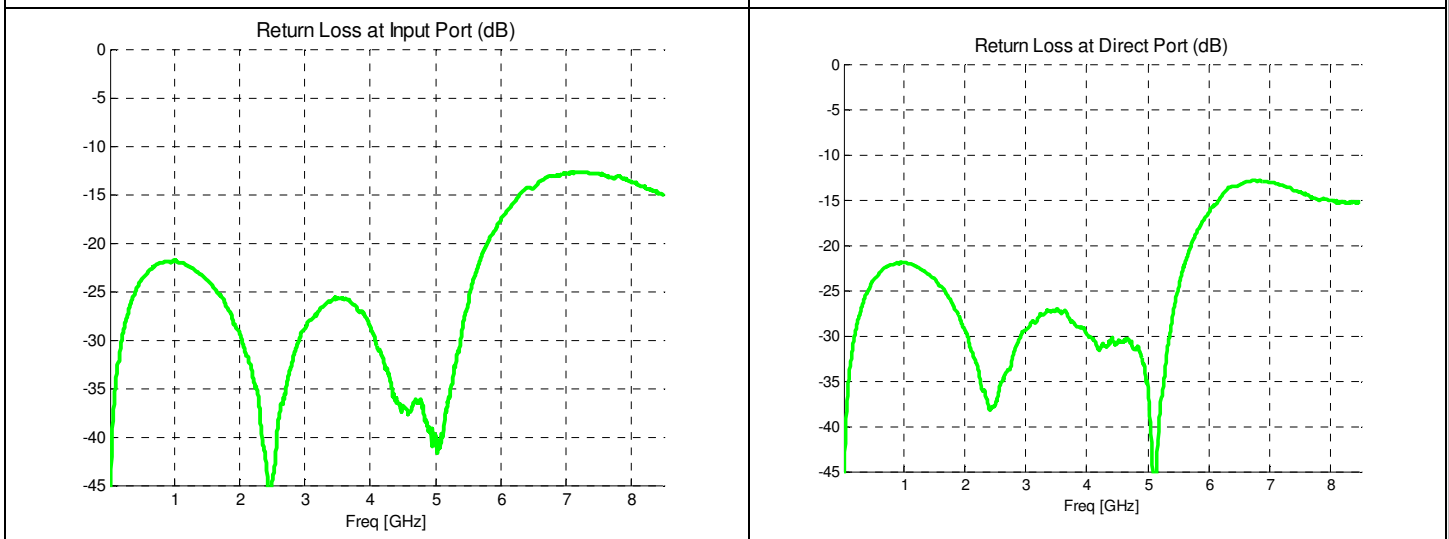
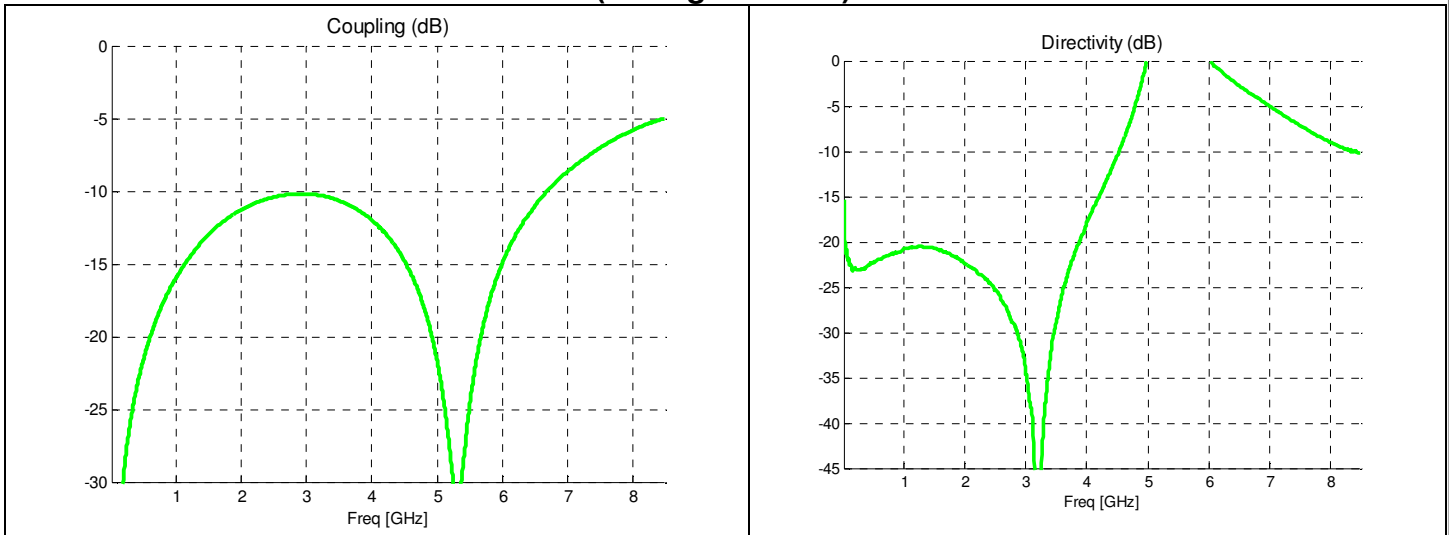

# Model DC2337J5010AHF

Rev C

# Anaren®

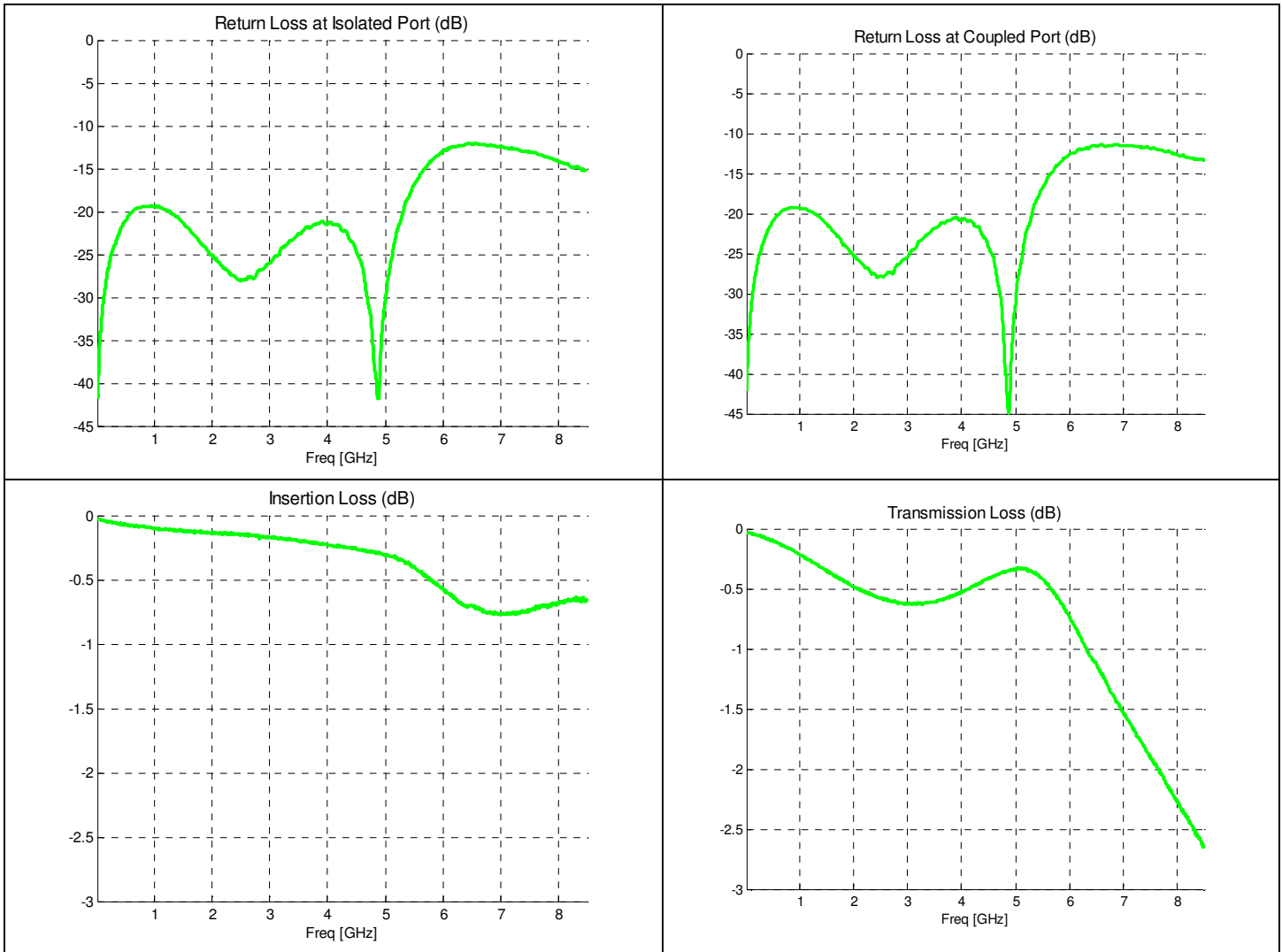

### Definition of Measured Specifications:

Parameter	Definition	Mathematical Representation for Pin Configuration 1	Mathematical Representation for Pin Configuration 2
<b>Return Loss</b>	The impedance match of the coupler to a 50Ω system. Return Loss is an alternate means to express VSWR.	Return Loss (dB)= $20\log_{10}( S_{ii} ) \quad i = 1, 2, 3, 4$	Return Loss (dB)= $20\log_{10}( S_{ii} ) \quad i = 1, 2, 3, 4$
<b>Mean Coupling</b>	At a given frequency ( $\omega_n$ ), coupling is the input power divided by the power at the coupled port. Mean coupling is the average value of the coupling values in the band. N is the number of frequencies in the band.	Coupling (dB) = $C = 20\log_{10} S_{34} $  Mean Coupling (dB) = $\frac{\sum_{n=1}^N C(\omega_n)}{N}$	Coupling (dB) = $C = 20\log_{10} S_{21} $  Mean Coupling (dB) = $\frac{\sum_{n=1}^N C(\omega_n)}{N}$
<b>Insertion Loss</b>	The input power divided by the sum of the power at the two output ports.	$10\log_{10}( S_{14} ^2 +  S_{34} ^2)$	$10\log_{10}( S_{41} ^2 +  S_{21} ^2)$
<b>Transmission Loss</b>	The input power divided by the power at the direct port.	$20\log_{10}( S_{14} )$	$20\log_{10}( S_{41} )$
<b>Directivity</b>	The power at the coupled port divided by the power at the isolated port.	$20\log_{10}\left(\frac{ S_{24} }{ S_{34} }\right)$	$20\log_{10}\left(\frac{ S_{31} }{ S_{21} }\right)$
<b>Frequency Sensitivity</b>	The decibel difference between the maximum in band coupling value and the minimum in band coupling value.	(Max Coupling (dB) – Min Coupling (dB))/2	(Max Coupling (dB) – Min Coupling (dB))/2

\*100% RF test is performed on configuration 1 where port 1 is connected to pin1, port 2 is connected to pin 2, port 3 is connected to pin 5 and port 4 is connected to pin 6.

## Mounting Configuration:

In order for Xinger surface mount components to work optimally, the proper impedance transmission lines must be used to connect to the RF ports. If this condition is not satisfied, insertion loss, Isolation and VSWR may not meet published specifications.

All of the Xinger components are constructed from organic PTFE based composites which possess excellent electrical and mechanical stability. Xinger components are compliant to a variety of ROHS and Green standards and ready for Pb-free soldering processes. Pads are Gold plated with a Nickel barrier.

An example of the PCB footprint used in the testing of these parts is shown below. In specific designs, the transmission line widths need to be adjusted to the unique dielectric coefficients and thicknesses as well as varying pick and place equipment tolerances.

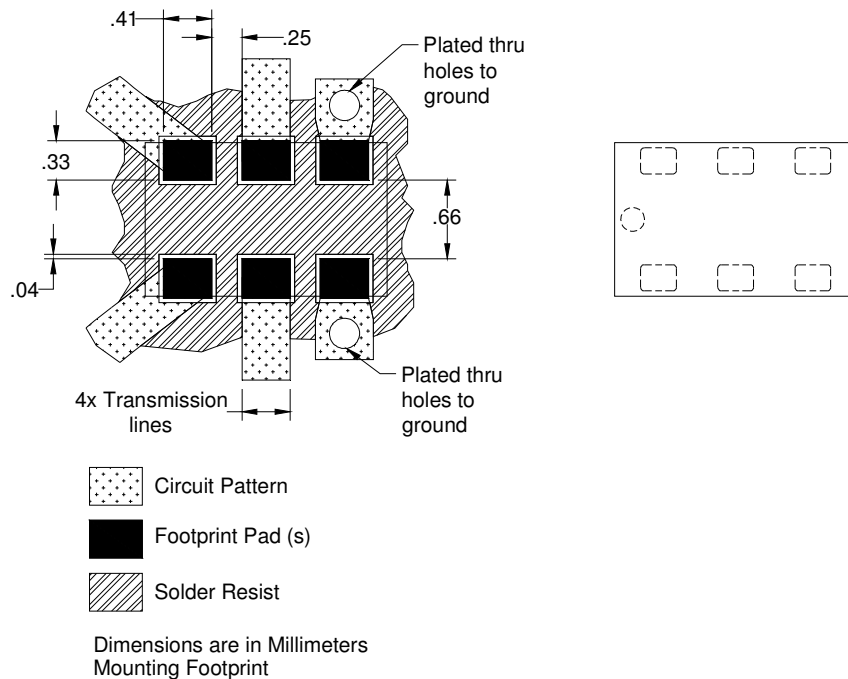

### Packaging and Ordering Information

Parts are available in reel and are packaged per EIA 481-D. Parts are oriented in tape and reel as shown below. Minimum order quantities are 4000 per reel.

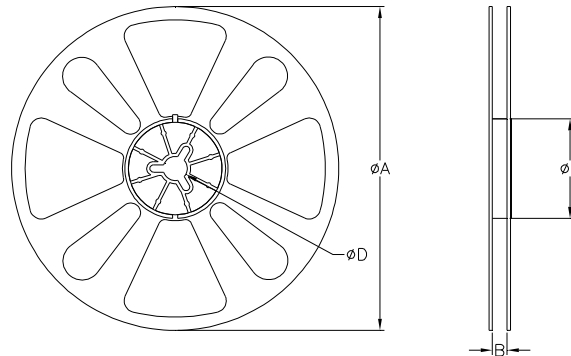
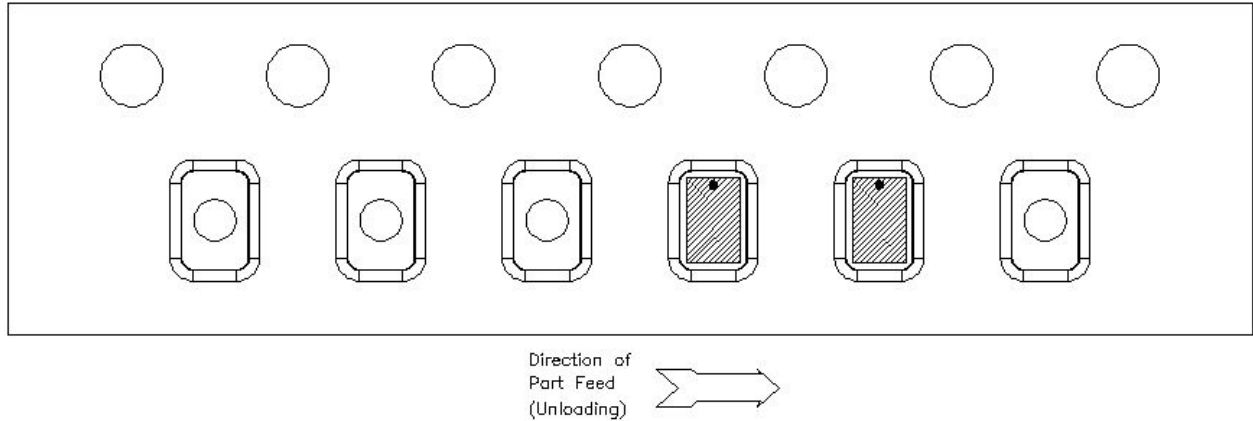

TABLE 1		
QUANTITY/REEL	REEL DIMENSIONS mm	
4000	$\phi A$	177.80
	B	8.00
	$\phi C$	50.80
	$\phi D$	13.00