



## Excelsys Product Catalogue

*The Power Solutions of Choice  
for Mission Critical Applications*

- ***Highest Efficiency***
- ***Highest Reliability***
- ***Highest Power Density***



**UltiMod**

The Ultimate Range of Modular Power Supplies for Industrial, Medical and Communications Applications



**Hi-Rel**

Hi-Rel Modular Power Supplies for Harsh Industrial and MIL-COTS Applications



**Solo**

Ultra Compact, Convection and Fan Cooled Single Output Power supplies for Industrial, Medical, MIL-COTS and Communications



**Gen**

Modular Power Supplies for Industrial, Medical, Communications and Acoustic Sensitive Applications

# CONTENTS

## Section 1 Introduction

Section 1.1	About Excelsys	04
-------------	----------------	----

## Section 2 Modular Product Datasheets

Section 2.1	UltiMod	UX4, UX6	05
Section 2.2	Ultra Quiet	XT, XN, XB, XW	09
Section 2.3	High Power	XCE, XVE, XLD, XMD	13
Section 2.4	XF	MIL-COTS/Hi Rel	17
Section 2.5	Xgen Series	XL, XM, XK, XR, XC, XV, XQ, XZ, XH	21
Section 2.6	Wide Trim Series	XgM, XgN, XgP, XgQ	40
Section 2.7	Reactive Load Series	XgR & XgT	42

## Section 3 Connectors, Derating, Mechanical Drawings & Configuration

Section 3.1	Connectors for Xgen Series	44
Section 3.2	Derating Curves for Xgen Series	45
Section 3.3	Mechanical Drawings for Modular Power Supplies	47
Section 3.4	Configuring your Modular Power Supply	51
Section 3.5	Accessories	52

## Section 4 Modular Designers Manual

Section 4.1	Overview of the UltiMod and Xgen Series	53
Section 4.2	Installation Considerations	53
Section 4.3	Mounting Considerations	53
Section 4.4	Theory of Operation	53
Section 4.5	Configuration	54
Section 4.6	<i>PowerMod</i> Operation	54
Section 4.7	<i>PowerMod</i> Signals	58
Section 4.8	<i>PowerPac</i> Operation	59
Section 4.9	<i>PowerPac</i> (Global) Signals	59
Section 4.10	<i>PowerPac</i> Options	60
Section 4.11	Power Ratings	60
Section 4.12	Acoustic Noise	60

## Section 5 Xsolo

Section 5.1	Xsolo Datasheet	61
Section 5.2	Xsolo Derating Curves	64
Section 5.3	Xsolo Connectors	65
Section 5.4	Xsolo Mechanical Drawings	66
Section 5.5	Configuring your Xsolo	67

## Section 6 Xsolo Designers Manual

Section 6.1	Xsolo Overview	68
Section 6.2	Xsolo Standard Features	68
Section 6.3	Xsolo Installation Considerations	69
Section 6.4	Xsolo Control and Signals(Analog)	69
Section 6.5	Parallel Connection and N+1 Redundant Operation	71
Section 6.6	Xsolo Options	72
Section 6.7	Xsolo Efficiency	72
Section 6.8	Xsolo Acoustic Noise	72

## Section 7 Reliability, Safety, EMI and Technical Resources

Section 7.1	Reliability	73
Section 7.2	Safety Approvals	73
Section 7.3	EMC Characteristics	74

# Section 1.1 About Excelsys

## Your Global Partner for Mission Critical Power Supplies

Excelsys Technologies brings over 20 years experience of leading edge power supply development and applications support to market with our revolutionary UltiMod, Xsolo and Xgen series of products. Our products deliver unrivalled levels of efficiency, flexibility, performance and reliability, all backed by a market leading 5 Year Warranty. We serve original equipment manufacturers globally from our head office in Ireland, our additional sales offices in the USA and China and our network of qualified and experienced manufacturer representatives and distributors in over 30 countries worldwide. Together we have established Excelsys as the brand of choice for customers seeking the highest performing, most reliable and most cost efficient power solutions.

### Serving Your Markets, Delivering Your Solutions:

Whatever your application, our dedicated teams of Sales and Applications Engineers are ready to assist you in defining and implementing the optimum power solution to meet your requirements. Some of the markets where Excelsys has demonstrated success include:



#### MEDICAL

Medical power supply design and manufacturing demands the highest safety and quality standards including UL/EN60601-1 3rd edition, 2 MOPP and 4kVAC Isolation. The medically certified solutions in the UltiMod, Xsolo and Xgen Platforms are the solutions of choice for a variety of applications including:

- Clinical Diagnostic Equipment • Medical Lasers • X-ray Machines • CT-Scanners • MRI Scanners • Dialysis Equipment • Skin Treatment and Regeneration • Cryotherapy Equipment • Cancer Treatment Equipment



#### INDUSTRIAL

Excelsys Technologies designs and manufactures power supplies that meet the rigorous demands of the industrial sector and its standards including EN60950 2nd edition and SEMI F47. Our products are ideal for a variety of industrial, automation and test & measurement applications including:

- Industrial Lasers • Optical Inspection Equipment • Electronic Microscopes • Printer & Binder Equipment • Wafer Fabrication • Camera Equipment • 3D Printing • Industrial Cutting Equipment

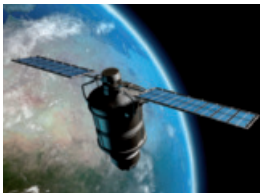

#### COMMUNICATIONS

The UltiMod, Xsolo, XF and Xgen range of power supplies meet the high reliability and stringent space requirements (1U) and standards including EN60950 2nd edition of the communications electronics sector and are used across a wide number of applications including:

- Wireless Telephony Equipment • Bulk Power System • Base Stations • Data Communications



#### HI-REL COTS

Excelsys designs and manufactures MIL-COTS (Commercial Off The Shelf) power supplies that meet the high reliability and often harsh operating environments of the military electronics industry. Excelsys Hi Rel MIL-COTS products are characterised to MIL-STD-461F, CE101 & CE102 conducted emissions, MIL-STD 810G, Integrity Test for Shock and Vibration and are ideal for use in a variety of applications including:

- Radar Systems • Data Acquisition (Ground Based and Mobile) • Communications Equipment • Test & Measurement Equipment

### Excelsys: Our commitment to you...

As a global supplier of modular power supplies, Excelsys combines the latest technology, management methods and a total customer service philosophy to provide the best performing and highest reliability solutions for your business.

Working closely with both our customers and channel partners we are committed to ensuring our products provide the lowest total cost of power supply ownership over the life of your system.





## *UltiMod*

*The UltiMod series from Excelsys - the Ultimate range of Modular Configurable Power Supplies*

- *Unique in Flexibility*
- *Unrivalled in Performance*
- *Ultra Cost Competitive*

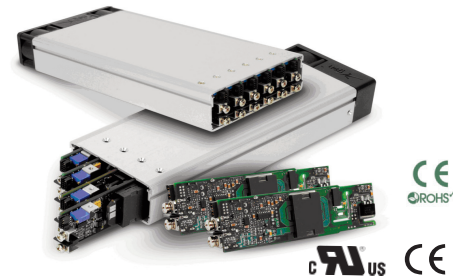

**Unique in Flexibility, Unrivalled in Performance, Ultra Cost Competitive**

**FEATURES & OPTIONS**

- Dual Safety Approvals
  - UL/EN60950 2nd edition
  - UL/EN60601-1 3rd edition
- Highest Efficiency - up to 91%
- User & Field Configurable
- Standard Medical Features
  - Leakage Current <300µA (<150µA optional)
  - 2 MOPP
  - 4KV Isolation
- Lowest Acoustic Noise
- -40°C Startup Temperature
- Extra Ruggedised Optional
  - Shock: >60G's
  - Vibration: MIL STD-810G
- No Minimum Load
- Extra low profile <1U height
- All outputs fully floating
- Series / Parallel of multiple outputs
- 5V Isolated standby voltage
- Active PFC (Power Factor Correction)
- Product Options: Conformal Coating, Low Leakage Current, Connector, Cabling & Mounting options and Reverse Fans Additional Ruggedisation

**TYPICAL APPLICATIONS**

- Medical; Clinical diagnostic equipment, Medical lasers, Dialysis equipment, Radiological Imaging, Clinical Chemistry
- Industrial; Test and Measurement, Industrial Machines, Automation equipment, Printing, Telecommunications, Audio equipment

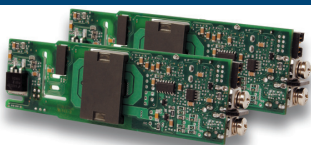

The UltiMod Series from Excelsys - the **Ultimate** range of Modular Configurable Power Supplies provides up to 1200W output power in a compact 1U form factor. The series is designed for **highest efficiencies** and consists of two Input AC front ends (*powerPacs*), UX4 and UX6 and a wide range of DC output modules (XgA-XgL & Xg1-Xg8).

Both *powerPacs* carry **dual safety certification**, EN60950 for Industrial Applications and EN60601-1 3rd Edition for Medical Applications. The UX4 delivers up to 600W and can be populated with up to 4 *powerMods*, the UX6 delivers up to 1200W and can be populated with up to 6 *powerMods*.

The *powerMods* provide up to 12 fully isolated DC outputs ranging from 1.15V to 58V. Users can select the modules most suitable for their application based on power level and/or desired control feature set. The series provides **unique levels of flexibility** and is completely user field configurable. Customers can configure any combination of *powerMods* in series/parallel. This unique flexibility combined with our Industry leading **5 Year Warranty** minimises the total cost of ownership for our customers.

**The UltiMod Series of modular configurable power supplies provides global leadership in product reliability, efficiency and cost effectiveness.**

**UltiMod powerPacs**

	Model	Slots	Power	Medical Approval UL/EN60601-1 3rd edition	Industrial Approval UL/EN60950 2nd edition
	UX4	4	600W	Yes	Yes
	UX6	6	1200W	Yes	Yes

**powerMods**

Model	Vnom (V)	Set Point Adjust Range (V)	Dynamic Vtrim Range (V)	I <sub>max</sub> (A)	Power (W)	Remote Sense	Power Good
XgA	12.0	10.8-15.6	-	12.5	150	-	-
XgB	24.0	19.2-26.4	-	8.3	200	-	-
XgC	36.0	28.8-39.6	-	5.6	200	-	-
XgD	48.0	38.5-50.4	-	4.2	200	-	-
XgE/Xg7	24.0	5.0-28.0	-	5.0	120	-	Yes
XgF/Xg8	24.0	5.0-28.0	-	3.0	72	-	Yes
	24.0	5.0-28.0	-	3.0	72	-	Yes
XgG	2.5	1.5-3.6	1.15-3.6	40.0	100	Yes	Yes
XgH	5.0	3.2-6.0	1.5-6.0	36.0	180	Yes	Yes
XgJ	12.0	6.0-15.0	4.0-15.0	18.3	220	Yes	Yes
XgK	24.0	12.0-30.0	8.0-30.0	9.2	220	Yes	Yes
XgL	48.0	28.0-58.0	8.0-58.0	5.0	240	Yes	Yes
Xg1	2.5	1.5-3.6	1.15-3.6	50.0	125	Yes	Yes
Xg2	5.0	3.2-6.0	1.5-6.0	40.0	200	Yes	Yes
Xg3	12.0	6.0-15.0	4.0-15.0	20.0	240	Yes	Yes
Xg4	24.0	12.0-30.0	8.0-30.0	10.0	240	Yes	Yes
Xg5	48.0	28.0-58.0	8.0-58.0	6.0	288	Yes	Yes

See our new Wide Trim *powerMods* on page 40 and Reactive Load *powerMods* on page 42.

INPUT					
Parameter	Conditions/Description	Min	Nom	Max	Units
Input Voltage Range	Universal Input 47-440Hz	85 120		264 380	VAC VDC
Power Rating	UX4: See derating curves UX6: See derating curves		600 1200		W W
Input Current	UX4 UX6	85VAC in 400W out 85VAC in 850W out	7.5 11.5		A
Inrush Current	230VAC @ 25°C UX6/UX4			25/50	A
Undervoltage Lockout	Shutdown	65		74	VAC
Power Factor	110 VAC @ Full Load	0.98	0.99		
Fusing	UX4 UX6	250V 250V	F8A HRC F12A HRC		
OUTPUT					
Parameter	Conditions/Description	Min	Nom	Max	Units
powerMod Power	As per powerMod table				
Output Adjustment Range	Manual: Multi-turn potentiometer. As per powerMod table Dynamic: As per powerMod table				
Minimum Load			0		A
Load & Cross Regulation	For 25% to 75% load change			±0.2	%
Transient Response	For 25% to 75% load change: Voltage Deviation; XgA-XgD Settling Time: XgA-XgD Voltage Deviation: XgE-XgL, Xg1-Xg8 Settling Time: XgE-XgL			2.5 500 10 250	% µs % µs
Ripple and Noise	20MHz 100mV or 1.0% pk-pk (except 150mV XgA)				
Overvoltage Protection	Latching	105		170	%
Overcurrent Protection	Straight line with hiccup activation at <30% of Vnom.	105		170	%
Line Regulation	For ±10% change from nominal line			±0.1	%
Remote Sense	Max. line drop compensation (except XgA, B, C, D, E, F)			0.5	VDC
Overshoot				2	%
Rise Time	Monotonic		15		ms
Turn-on Delay	From AC in and Global Enable powerMod Enable		700 2		ms ms
Hold-up Time	For nominal output voltages at full load.	15		20	ms
Output Isolation	Output to Output/Output to Chassis	500 / 500			VDC
GENERAL					
Parameter	Conditions/Description	Min	Nom	Max	Units
Isolation Voltage	Input to Output Input to Chassis	4000 1500			VAC VAC
Efficiency	230VAC, 1200W @ 24V		90	91	%
Safety Agency Approvals	EN60601-1 3rd Edition, UL60601-1, CSA601, UL File No. E230761 EN60950 2nd Edition, CSA C22.2 No. 60950-1, UL File No.E181875				
Leakage Current	250VAC, 60Hz, 25°C 250VAC, 60Hz, 25°C (Option 04)			300 150	µA µA
Weight	See weight calculators on Excelsys website				
Signals	See section 4.9				
Bias Supply	Always on, current 500mA	4.8	5.0	5.2	VDC
Reliability	Failures per million hours at 40°C and full load powerMod See Section 7.1 . powerPac excludes fans powerPac			0.958 0.92	fpmh fpmh
MTBF	UX4 with two XgA's @ full load. Telecordia SR-332 , Issue 1 May 2001, ground benign, ambient temperature of 40°C	670			kHours
EMC					
Parameter	Standard	Level		Units	
<b>Emissions</b>					
Conducted	EN55011, EN55022, FCC		Class B		
Radiated	EN55011, EN55022, FCC		Class B		
Harmonic Distortion	EN61000-3-2 Class A		Compliant		
Flicker & Fluctuation	EN61000-3-3		Compliant		
<b>Immunity</b>					
Electrostatic Discharge	EN61000-4-2		Level 2		
Radiated Immunity	EN61000-4-3		Level 3		
Fast Transients-Burst	EN61000-4-4		Level 3		
Input Line Surges	EN61000-4-5		Level 3		
Conducted Immunity	EN61000-4-6		Level 3		
Voltage Dips	EN61000-4-11, SEMI F47 Compliant <sup>(1)</sup>		Compliant		
ENVIRONMENTAL					
Parameter	Conditions/Description	Min	Nom	Max	Units
Operating Temperature	Operates to specification below -20°C after 10 min warm-up	-40		+70	°C
Storage Temperature		-40		+85	°C
Derating	See Page 8 for full temperature deratings				
Relative Humidity	Non-condensing	5		95	%RH
Acoustic Noise	Measured from distance of 1m; UX4/UX6. See Page 58 for full table		39.8/42.7		dBA
Shock		60			G
Vibration	MIL-STD810G				
Altitude	Operational: 2000m, Storage: 8000m				

- NOTES**
- SEMI F47 compliant at input voltages >160VAC. Consult Excelsys for details.
  - Visit [www.excelsys.com](http://www.excelsys.com) for configuration and ordering and contact information.
  - Product is not UL/EN certified for 120-380VDC input operation. Consult Excelsys for details.

**Output Connectors**

The output *powerMods* connection details are shown below. Type A connectors are for single output *powerMods* XgA-XgT and Xg1-Xg7. The Type B connector is for the dual output XgF/Xg8 *powerMod*. The power and signal connectors are as follows:

**Type A: *powerMods***  
XgA to XgE  
XgG to XgT  
Xg1 to Xg7

**Type B: *powerMod***  
XgF/Xg8

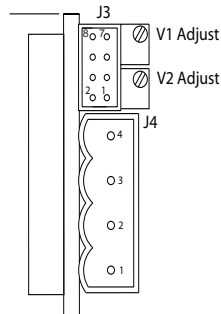
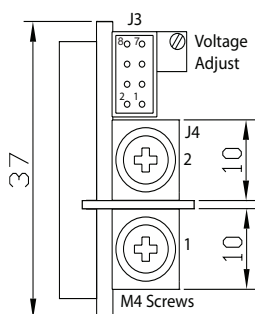

**Output Signals and Power Connector Pinout**

Pin	J3 Module (XgA to XgD)	J3 (XgG-XgT) (Xg1-Xg5)	J3 (XgE) (Xg7)	J3 (XgF) (Xg8)	J4 (Type A)	J4 (Type B)
1	not used	+Sense*	not used	-pg (V2)	-Vout	-V2
2	Common	-Sense*	not used	+pg (V2)	+Vout	+V2
3	not used	Vtrim	not used	Inhibit V2)		-V1
4	not used	Itrim	Common	Common (V2)		+V1
5	+Inhibit	+Inhibit/Enable	-pg	-pg (V1)		
6	-Inhibit	-Inhibit/Enable	+pg	+pg (V1)		
7	not used	+pg	Inhibit	Inhibit (V1)		
8	not used	-pg	Common	Common (V1)		

\*remote sense not present on XgR and XgT *powerMods*.

**Output Mating Connectors**

J3: Locking Molex 51110-0860; Non Locking Molex 51110-0850; Crimp Terminal: Molex p/n 50394. Or Molex 51110-0856, includes Locking Tab & Polarization Keying,

J4 (Type A): M4 Screw (8mm)

J4 (Type B) Connector(s): Camden CTB9200/4A

**Input Connectors**

The UltiMod series has a variety of input connector options to ease system integration. These include IEC, Input cables (3-wire) and IEC to Screw Terminal Adaptor.

**J1 & J2 Connectors UX4**

**J1 & J2 Connectors UX6**

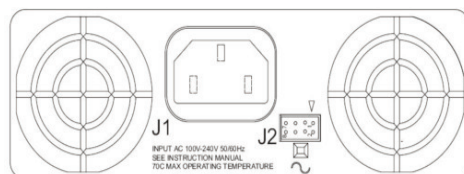
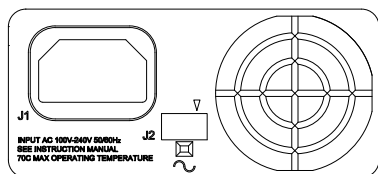

Pin	J1	J2
1	Line	Common
2	Neutral	+5V Bias
3	Earth	not used
4		AC Fail
5		Fan Fail
6		Global Enable
7		Temp Alarm
8		Global Inhibit

**Input Mating Connectors**

J1: IEC320 type female plug rated 13, Locking IEC cable and connector: Schaffner EMC part number IL13-US1-SVT-3100-183.

J2: Locking Molex 51110-0860; Non Locking 51110-0850; Crimp Terminal: Molex p/n 50394. Or Molex 51110-0856, includes Locking Tab & Polarization Keying

**Input Cable (Option D)**

The UltiMod Series is also available with an input cable connection option allowing greater flexibility when mounting the UltiMod in the system. Individually insulated input cables are 300mm in length and come supplied with Faston connectors.

**IEC to Screw Terminal Adaptor**

Some applications may require a screw terminal input rather than the standard IEC320 connector provided with the UltiMod. For such applications, Excelsys can offer the XE1, the IEC to Screw terminal adaptor accessory plug. This is a press fit connector that plugs securely into the UltiMod *powerPac* and provides the system integrator with screw terminals for mains connection. Recommended IEC to Faston/Terminal Lugs Schurter P/N 4788.8000

**Derating Curves**

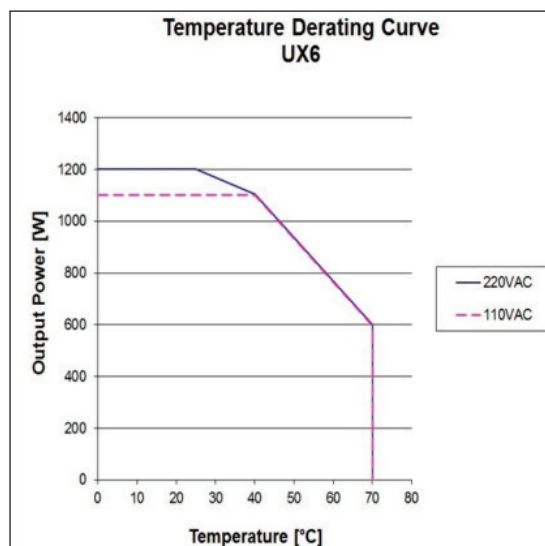
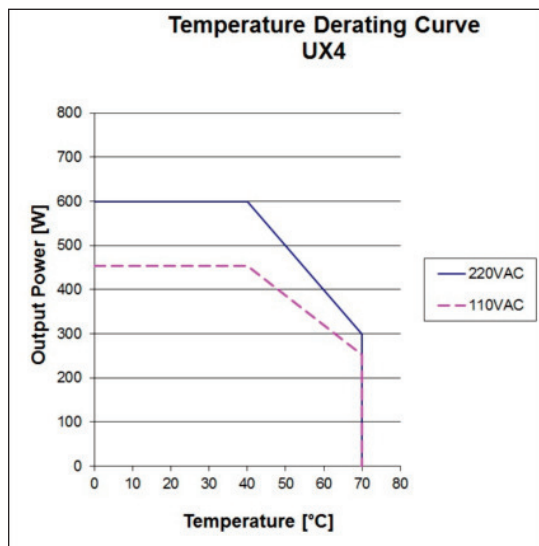





## Xgen Series Ultra Quiet

*The Modular Power Solution of Choice  
for Acoustic Sensitive Applications*

- *High Efficiency*
- *High Reliability*
- *High Power Density*

# 200W-800W

## Ultra Quiet Power Supply

Ultra-high efficiency 1U size



### PLUG & PLAY POWER next generation power solution

#### FEATURES & OPTIONS

- Low Acoustic noise 37.3dBA
- Ultra high efficiency, up to 89%
- Extra low profile: 1U height (40mm)
- Plug & Play Power - allows fast custom configuration
- Individual output control signals
- All outputs fully floating
- Series / Parallel of multiple outputs
- Few electrolytic capacitors (all long life)
- Visual LED indicators
- 5V bias standby voltage provided
- Active PFC (Power Factor Correction)
- Standard Xgen product options include: Conformal Coating, Low Acoustic Noise, Low Leakage Current, Extra Ruggedisation, Connector, Cabling & Mounting options, Thermal Signals and Reverse Fans. See Section 4.10 for more information

#### APPLICATIONS INCLUDE

- Audio Equipment
- Test and measurement
- Telecommunications
- Medical/Scientific

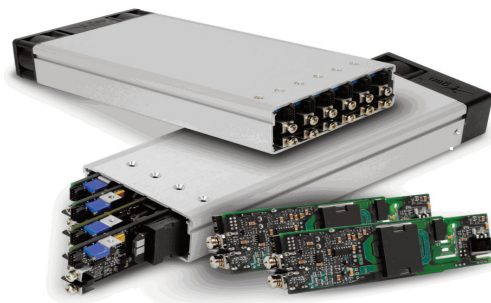

The Ultra-Quiet series from Excelsys delivers the lowest acoustic noise solutions in the market, providing up to 800W of output power in an extremely compact 1U package. Application specific solutions are available in either a 4 slot or 6-slot form factor which employ a unique plug and play architecture allowing users to configure a custom power supply in less than 5 minutes.

The series is designed for highest efficiencies and lowest acoustic noise and consists of 10 *powerPacs* allowing customers to select the optimal solution based on the certifications and power levels required in their system. These *powerPacs* can be fitted with any combination of 24 available *powerMod*'s, so users can select the modules most suitable for their application based on power level and/or desired control feature set.

All configurations carry full safety agency approvals, UL60950/EN60950/UL60601-1/EN60601-1 and are CE marked.

#### powerMods

Model	Vnom (V)	Set Point Adjust Range (V)	Dynamic Vtrim Range (V)	I <sub>max</sub> (A)	Power (W)	Remote Sense	Power Good
XgA	12.0	10.8-15.6	-	12.5	150	-	-
XgB	24.0	19.2-26.4	-	8.3	200	-	-
XgC	36.0	28.8-39.6	-	5.6	200	-	-
XgD	48.0	38.5-50.4	-	4.2	200	-	-
XgE/Xg7	24.0	5.0-28.0	-	5.0	120	-	Yes
XgF/Xg8	24.0	5.0-28.0	-	3.0	72	-	Yes
	24.0	5.0-28.0	-	3.0	72	-	Yes
XgG	2.5	1.5-3.6	1.15-3.6	40.0	100	Yes	Yes
XgH	5.0	3.2-6.0	1.5-6.0	36.0	180	Yes	Yes
XgJ	12.0	6.0-15.0	4.0-15.0	18.3	220	Yes	Yes
XgK	24.0	12.0-30.0	8.0-30.0	9.2	220	Yes	Yes
XgL	48.0	28.0-58.0	8.0-58.0	5.0	240	Yes	Yes
Xg1	2.5	1.5-3.6	1.15-3.6	50.0	125	Yes	Yes
Xg2	5.0	3.2-6.0	1.5-6.0	40.0	200	Yes	Yes
Xg3	12.0	6.0-15.0	4.0-15.0	20.0	240	Yes	Yes
Xg4	24.0	12.0-30.0	8.0-30.0	10.0	240	Yes	Yes
Xg5	48.0	28.0-58.0	8.0-58.0	6.0	288	Yes	Yes

#### powerPacs

	MODEL	Slots	Power	Medical Approval	
				UL/EN60601-1 3 <sup>rd</sup> Edition	(Industrial) UL/EN60950 2 <sup>nd</sup> Edition
Ultra Quiet	XTA	4	200W	No	Yes
	XTB	4	400W	No	Yes
	XNA	4	200W	Yes	No
	XNB	4	400W	Yes	No
	XBA	6	400W	No	Yes
	XBB	6	600W	No	Yes
	XBC	6	800W	No	Yes
	XWA	6	400W	Yes	No
	XWB	6	600W	Yes	No
	XWC	6	800W	Yes	No

See our new Wide Trim *powerMods* on page 40 and Reactive Load *powerMods* on page 42.

**SPECIFICATION** applies to configured units consisting of *powerMods* plugged into the appropriate *powerPac*

INPUT					
Parameter	Conditions/Description	Min	Nom	Max	Units
Input Voltage Range	Universal Input 47-440Hz	85 120		264 380	VAC VDC
Power Rating	See powerPac table on page 10. See Section 3.2 for line voltage deratings				
Input Current	XTA/XNA XTB/XNB XBA/XWA XBB/XWB XBC/XWC	85VAC in 200W out 85VAC in 283W out 85VAC in 400W out 85VAC in 600W out 85VAC in 625W out		4.5 5.0 7.5 9.5 11.5	A A A A A
Inrush Current	230VAC, 25°C 4 Slot/6 Slot			50/25	A
Undervoltage Lockout	Shutdown	65		74	VAC
Power Factor	110 VAC @ Full Load	0.98	0.99		
Fusing	XTA/XNA XTB/XNB XBA/XWA XBB/XWB XBC/XWC	250V 250V 250V 250V 250V		F5A HRC F6.3A HRC F8A HRC F10A HRC F12A HRC	
OUTPUT					
Parameter	Conditions/Description	Min	Nom	Max	Units
powerMod Power	As per powerMod table				
Output Adjustment Range	Manual: Multi-turn potentiometer. As per powerMod table Electronic:				
Line Regulation	For ±10% change from nominal line			±0.1	%
Load & Cross Regulation	For 25% to 75% load change			±0.2	%
Transient Response	For 25% to 75% load change Voltage Deviation Settling Time			10 250	% µs
Ripple and Noise	20MHz 100mV or 1.0% pk-pk				
Overvoltage Protection	1st level: Vset Tracking. 2nd level: Vmax (Latching)	105		170	%
Overcurrent Protection	Straight line with hiccup activation at <30% of Vnom See Section 4.6	105		170	%
Remote Sense	Max. line drop compensation. (except Xg7, Xg8, XgE, XgF, XgR, XgT)			0.5	VDC
Overshoot				2	%
Turn-on Delay	From AC in and Global Enable / powerMod Enable			700 / 6	ms
Rise Time	Monotonic			5	ms
Hold-up Time	For nominal output voltages at full load. XTB & XNB XTA, XNA, XBA, XBB, XBC, XWA, XWB, XWC	15 20			ms ms
Output Isolation	Output to Output / Output to Chassis	500 / 500			VDC
GENERAL					
Parameter	Conditions/Description	Min	Nom	Max	Units
Isolation Voltage	Input to Output (Industrial/Medical) Input to Chassis	3000/4000 1500			VAC VAC
Efficiency	230VAC, full load @ 24V		89		%
Safety Agency Approvals	EN60601-1 3rd Edition, UL60601-1, CSA601, UL File No. E230761 EN60950 2nd Edition, CSA C22.2 No. 60950-1, UL File No. E181875				
Leakage Current	250VAC, 60Hz, 25°C; Industrial Medical Low leakage Current Medical (Option 4)			1.5 300 150	mA µA µA
Weight	See weight calculators on Excelsys website				
Signals	See Section 4.9				
Bias Supply	Always on. Current 500mA.	4.8	5.0	5.2	VDC
Reliability	Failures per million hours at 40°C and full load powerMod See Section 7.1 . powerPac excludes fans powerPac			0.958 0.92	fpmh fpmh
EMC					
Parameter	Standard	Level	Units		
Conducted	EN55011, EN55022, FCC	Class B			
Radiated	EN55011, EN55022, FCC	Class B			
Harmonic Distortion	EN61000-3-2 Class A	Compliant			
Flicker & Fluctuation	EN61000-3-3	Compliant			
Electrostatic Discharge	EN61000-4-2	Level 2			
Radiated Immunity	EN61000-4-3	Level 3			
Fast Transients-Burst	EN61000-4-4	Level 3			
Input Line Surges	EN61000-4-5	Level 3			
Conducted Immunity	EN61000-4-6	Level 3			
Voltage Dips	EN61000-4-11, SEMI F47 Compliant <sup>®</sup>	Compliant			
ENVIRONMENTAL					
Parameter	Conditions/Description	Min	Nom	Max	Units
Temperature	Operating/Storage	-20/-40		+70/+85	°C
Derating	See Section 3.2 for full temperature deratings				
Relative Humidity	Non-condensing	5		95	%RH
Acoustic Noise	Measured from distance of 1m; 4-slot/6-slot		37.3/38.3		dB(A)
Shock	3000 Bumps, 10G (16ms) half sine				
Vibration	1.5G	10		200	Hz
Altitude	Operational: 2000m, Storage: 8000m				

**NOTES**

1. This product is not intended for use as a stand alone unit and must be installed by qualified personnel.
2. The specifications contained herein are believed to be correct at time of publication and are subject to change without notice.
3. All specifications at nominal input, full load, 25°C unless otherwise stated.
4. When powering inductive or capacitive loads, it is recommended to use a blocking diode on the output.
5. SEMI F47 compliant at input voltages >160VAC. Consult Excelsys for details
6. Visit [www.excelsys.com](http://www.excelsys.com) for configuration and ordering and contact information.
7. Conformal Coating option: See Sections 3.4 and 4.10 for details.
8. Product is not UL/EN certified for 120-380VDC input operation. Consult Excelsys for details.

**Output Connectors**

The output *powerMods* connection details are shown below. Type A connectors are for single output *powerMods* XgA-XgT and Xg1-Xg7. The Type B connector is for the dual output XgF/Xg8 *powerMod*. The power and signal connectors are as follows:

**Type A: *powerMod*s**  
XgA to XgE  
XgG to XgT  
Xg1 to Xg7

**Type B: *powerMod***  
XgF/Xg8

**Output Signals and Power Connector Pinout**

Pin	J3 Module (XgA to XgD)	J3 (XgG-XgT) (Xg1-Xg5)	J3 (XgE) (Xg7)	J3 (XgF) (Xg8)	J4 (Type A)	J4 (Type B)
1	not used	+Sense*	not used	-pg (V2)	-Vout	-V2
2	Common	-Sense*	not used	+pg (V2)	+Vout	+V2
3	not used	Vtrim	not used	Inhibit V2)		-V1
4	not used	Itrim	Common	Common (V2)		+V1
5	+Inhibit	+Inhibit/Enable	-pg	-pg (V1)		
6	-Inhibit	-Inhibit/Enable	+pg	+pg (V1)		
7	not used	+pg	Inhibit	Inhibit (V1)		
8	not used	-pg	Common	Common (V1)		

\*remote sense not present on XgR and XgT *powerMods*.

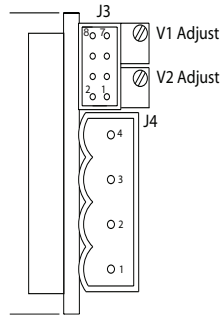
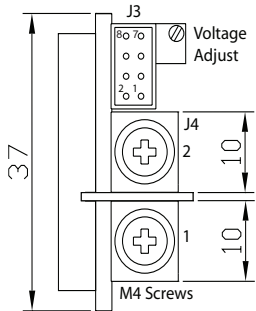

**Output Mating Connectors**

J3: Locking Molex 51110-0860; Non Locking Molex 51110-0850; Crimp Terminal: Molex p/n 50394. Or Molex 51110-0856, includes Locking Tab & Polarization Keying

J4 (Type A): M4 Screw (8mm)

J4 (Type B) Connector(s): Camden CTB9200/4A

**Input Connectors**

Excelsys modular power supplies have a variety of input connector options to ease system integration. These include IEC, Input cables (3-wire) and IEC to Screw Terminal Adaptor.

**J1 & J2 Connectors 4-slot**

**J1 & J2 Connectors 6-slot**

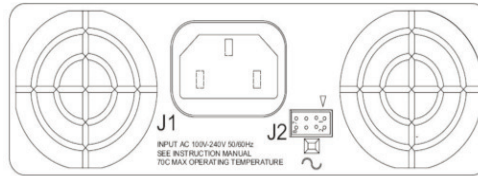
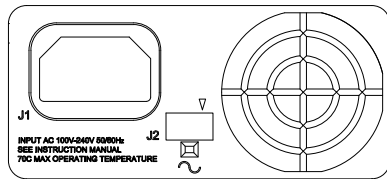

Pin	J1	J2
1	Line	Common
2	Neutral	+5V Bias
3	Earth	not used
4		AC Fail
5		Fan Fail
6		Global Enable
7		Temp Alarm
8		Global Inhibit

**Input Mating Connectors**

J1: IEC320 type female plug rated 13, Locking IEC cable and connector: Schaffner EMC part number IL13-US1-SVT-3100-183.

J2: Locking Molex 51110-0860; Non Locking 51110-0850; Crimp Terminal: Molex p/n 50394; Or Molex 51110-0856, includes Locking Tab & Polarization Keying

**Input Cable (Option D)**

Excelsys modular power supplies are also available with an input cable connection option allowing greater flexibility when mounting the power supply in the system. Individually insulated input cables are 300mm in length and come supplied with Faston connectors.

**IEC to Screw Terminal Adaptor**

Some applications may require a screw terminal input rather than the standard IEC320 connector provided with Excelsys modular power supplies. For such applications, Excelsys can offer the XE1, the IEC to Screw terminal adaptor accessory plug. This is a press fit connector that plugs securely into the *powerPac* and provides the system integrator with screw terminals for mains connection (not available on XCE, XVE, XMD, XLD, XF). Recommended IEC to Faston/Terminal Lugs Schurter P/N 4788.8000



## Xgen Series High Power

*The Modular Power Solution of Choice  
for Mission Critical Applications*

- *High Efficiency*
- *High Reliability*
- *High Power Density*

# 750W-1340W

## Xgen High Power AC/DC Power Supply

Ultra-high efficiency 1U size



### PLUG & PLAY POWER next generation power solution

#### FEATURES & OPTIONS

- Ultra high efficiency, up to 90%
- Extra low profile < 1U height
- Plug & Play Power – allows fast custom configuration
- UL/EN60950 2nd edition
- UL/EN60601-1 3rd edition
- 4KV isolation (medical)
- SEMI F47 compliant
- -40C start up temperature
- All outputs fully floating
- Series/Parallel of outputs
- Active PFC (Power Factor Correction)
- Standard Xgen product options include: Conformal Coating, Low Leakage Current, Extra Ruggedisation, Connector, Cabling and Mounting options, Reverse Fans.

#### APPLICATIONS INCLUDE

- Medical:** Clinical diagnostic equipment, Medical lasers, Dialysis, Radiological Imaging equipment, Clinical Chemistry
- Industrial:** Test & Measurement, Industrial Machines, Automation equipment, Printing, Telecommunications, Audio equipment

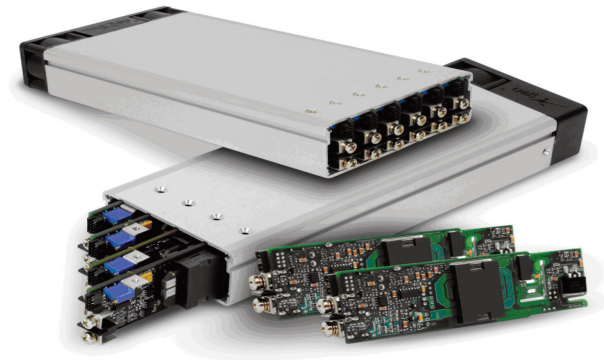

The Xgen High Power family of industrial and medically approved power supplies provide up to an incredible 1340W in an extremely compact 1U package. Providing up to 12 isolated DC outputs, the Xgen High Power family employs innovative plug & play architecture allowing users to instantly configure a custom power solution in less than 5 minutes!

The Xgen High Power family consists of 4 *powerPacs*. The XLD and XMD *powerPacs* provide up to 750W can be populated with up to 4 *powerMods*, while the XCE and XVE provide up to 1340W and can be populated with up to 6 *powerMods*. Simply select the appropriate *powerPac* and up to 6 *powerMods* from the tables below to complete your custom power supply.

The series boasts industry leading power density of 17W/in<sup>3</sup> and ultra-high efficiencies (up to 90%). The significant system space savings and reduced heat dissipation radically simplify system design.

XLD and XCE parts are approved to EN60950 2nd edition and are ideal for wide range of industrial applications. XMD and XVE parts carry full medical safety agency approvals including UL/EN60601-1 2nd and 3rd Edition, 2MOPP and 4kVAC, CSA as well as carrying the CE mark.

#### powerMods

Model	Vnom (V)	Set Point Adjust Range (V)	Dynamic Vtrim Range (V)	I <sub>max</sub> (A)	Power (W)	Remote Sense	Power Good
XgA	12.0	10.8-15.6	-	12.5	150	-	-
XgB	24.0	19.2-26.4	-	8.3	200	-	-
XgC	36.0	28.8-39.6	-	5.6	200	-	-
XgD	48.0	38.5-50.4	-	4.2	200	-	-
XgE/Xg7	24.0	5.0-28.0	-	5.0	120	-	Yes
XgF/Xg8	24.0	5.0-28.0	-	3.0	72	-	Yes
	24.0	5.0-28.0	-	3.0	72	-	Yes
XgG	2.5	1.5-3.6	1.15-3.6	40.0	100	Yes	Yes
XgH	5.0	3.2-6.0	1.5-6.0	36.0	180	Yes	Yes
XgJ	12.0	6.0-15.0	4.0-15.0	18.3	220	Yes	Yes
XgK	24.0	12.0-30.0	8.0-30.0	9.2	220	Yes	Yes
XgL	48.0	28.0-58.0	8.0-58.0	5.0	240	Yes	Yes
Xg1	2.5	1.5-3.6	1.15-3.6	50.0	125	Yes	Yes
Xg2	5.0	3.2-6.0	1.5-6.0	40.0	200	Yes	Yes
Xg3	12.0	6.0-15.0	4.0-15.0	20.0	240	Yes	Yes
Xg4	24.0	12.0-30.0	8.0-30.0	10.0	240	Yes	Yes
Xg5	48.0	28.0-58.0	8.0-58.0	6.0	288	Yes	Yes

#### powerPacs

	MODEL	Slots	Power	Medical Approval	
				UL/EN60601-1 3 <sup>rd</sup> Edition	(Industrial) UL/EN60950 2 <sup>nd</sup> Edition
High Power	XLD	4	750W	No	Yes
	XMD	4	750W	Yes	No
	XCE	6	1340W	No	Yes
	XVE	6	1340W	Yes	No

See our new Wide Trim *powerMods* on page 40 and Reactive Load *powerMods* on page 42.

**SPECIFICATION** applies to configured units consisting of *powerMods* plugged into the appropriate *powerPac*

INPUT					
Parameter	Conditions/Description	Min	Nom	Max	Units
Input Voltage Range	Universal Input 47-440Hz	85 120		264 380	VAC VDC
Power Rating	XLD/XMD: 750W. XCE/XVE: 1340W See section 3.2 derating curves				
Input Current	XLD/XMD XCE/XVE		7.5 14.5		A
Inrush Current	230VAC @ 25°C XLD & XMD/ XCE & XVE			50/25	A
Undervoltage Lockout	Shutdown	65		74	VAC
Power Factor	110 VAC @ Full Load	0.98	0.99		
Fusing	XLD/XMD XCE/XVE	250V 250V		F8A HRC F12A HRC	
OUTPUT					
Parameter	Conditions/Description	Min	Nom	Max	Units
<i>powerMod</i> Power	As per <i>powerMod</i> table				
Output Adjustment Range	Manual: Multi-turn potentiometer. As per <i>powerMod</i> table Electronic: See Section 4.6				
Minimum Load	Minimum load required for operation above 40°C. See table on page 16		0		A
Line Regulation	For ±10% change from nominal line			±0.1	%
Load & Cross Regulation	For 25% to 75% load change			±0.2	%
Transient Response	For 25% to 75% load change: Voltage Deviation Settling Time			10 250	% µs
Ripple and Noise	20MHz 100mV or 1.0% pk-pk				
Overvoltage Protection	Two-level. 1st level: Vset Tracking. 2nd level: Vmax (Latching)	105		170	%
Overcurrent Protection	Straight line with hiccup activation at <30% of Vnom. See Section 4.6	105		170	%
Remote Sense	Max. line drop compensation (except Xg7, Xg8, XgE, XgF, XgR, XgT)			0.5	VDC
Overshoot				2	%
Rise Time	Monotonic			5	ms
Turn-on Delay	From AC in and Global Enable			1000/6	ms
Hold-up Time	For nominal output voltages at full load.		15		ms
Output Isolation	Output to Output/Output to Chassis	500 / 500			VDC
GENERAL					
Parameter	Conditions/Description	Min	Nom	Max	Units
Isolation Voltage	Input to Output Input to Chassis	4000 1500			VAC VAC
Efficiency	230VAC, 1340W @ 24V		90		%
Safety Agency Approvals	XLD & XCE XMD & XVE	EN60950 2nd Edition, UL60950, CSA 22.2 Number 60950-1: UL File Number E181875 EN60601-1 3rd Edition, UL60601-1, CSA601 UL File Number E230761			
Earth Leakage Current	250VAC, 60Hz, 25°C XLD & XCE/XMD & XVE 250VAC, 60Hz, 25°C (Option 04)			1.5/300 150	mA/ µA µA
Weight	See weight calculators on Excelsys website				
Signals	See section 4.9				
Bias Supply	Always on. Current 500mA (250mA for XCE/XVE)	4.8	5.0	5.2	VDC
Reliability	Failures per million hours at 40°C and full load See Section 7.1 . <i>powerPac</i> excludes fans			0.958 0.946	fpmh fpmh
EMC					
Parameter	Standard	Level		Units	
<b>Emissions</b>					
Conducted	EN55011, EN55022, FCC		Class B		
Radiated	EN55011, EN55022, FCC		Class B		
Harmonic Distortion	EN61000-3-2 Class A		Compliant		
Flicker & Fluctuation	EN61000-3-3		Compliant		
<b>Immunity</b>					
Electrostatic Discharge	EN61000-4-2		Level 2		
Radiated Immunity	EN61000-4-3		Level 3		
Fast Transients-Burst	EN61000-4-4		Level 3		
Input Line Surges	EN61000-4-5		Level 3		
Conducted Immunity	EN61000-4-6		Level 3		
Voltage Dips	EN61000-4-11, SEMI 47 compliant <sup>(6)</sup>		Compliant		
ENVIRONMENTAL					
Parameter	Conditions/Description	Min	Nom	Max	Units
Operating Temperature		-20		+70	°C
Storage Temperature		-40		+85	°C
Derating	See Section 3.2 for full temperature deratings				
Relative Humidity	Non-condensing	5		95	%RH
Acoustic Noise	Measured from distance of 1m; 4 slot/6 slot. See Page 58 for full table		52.8/56.5		dBA
Shock	3000 Bumps, 10G (16ms) half sine				
Vibration	MIL-STD810G				
Altitude	Operational: 2000m, Storage: 8000m				

**NOTES**

1. This product is not intended for use as a stand alone unit and must be installed by qualified personnel.
2. The specifications contained herein are believed to be correct at time of publication and are subject to change without notice.
3. All specifications at nominal input, full load, 25°C unless otherwise stated.
4. XLD/XMD: 800W peak for 1s; Duty Cycle 7% *powerMod* output power must not exceed normal ratings
5. XCE/XVE: 1450W peak for 10s; Duty Cycle 8%. *powerMod* output power must not exceed normal ratings
6. When powering inductive or capacitive loads, it is recommended to use a blocking diode on the output.
7. Conformal Coating option: See Sections 3.4 and 4.10 for details.
8. SEMI F47 compliant at input voltages >160VAC. Consult Excelsys for details.
9. Visit [www.excelsys.com](http://www.excelsys.com) for configuration and ordering and contact information.
10. Product is not UL/EN certified for 120-380VDC input operation. Consult Excelsys for details.

# 750W-1340W

## Output Connectors

The output *powerMods* connection details are shown below. Type A connectors are for single output *powerMods* XgA-XgT and Xg1-Xg7. The Type B connector is for the dual output XgF/Xg8 *powerMod*. The power and signal connectors are as follows:

**Type A: *powerMods***  
XgA to XgE  
XgG to XgT  
Xg1 to Xg7

**Type B: *powerMod***  
XgF/Xg8

## Output Signals and Power Connector Pinout

Pin	J3 Module (XgA to XgD)	J3 (XgG-XgT) (Xg1-Xg5)	J3 (XgE) (Xg7)	J3 (XgF) (Xg8)	J4 (Type A)	J4 (Type B)
1	not used	+Sense*	not used	-pg (V2)	-Vout	-V2
2	Common	-Sense*	not used	+pg (V2)	+Vout	+V2
3	not used	Vtrim	not used	Inhibit (V2)		-V1
4	not used	Itrim	Common	Common (V2)		+V1
5	+Inhibit	+Inhibit/Enable	-pg	-pg (V1)		
6	-Inhibit	-Inhibit/Enable	+pg	+pg (V1)		
7	not used	+pg	Inhibit	Inhibit (V1)		
8	not used	-pg	Common	Common (V1)		

\*remote sense not present on XgR and XgT *powerMods*.

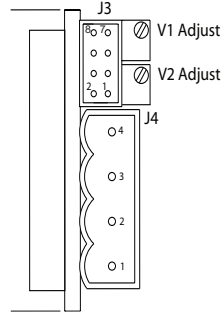
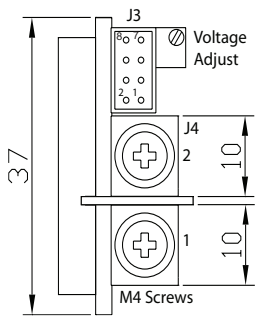

## Output Mating Connectors

J3: Locking Molex 51110-0860; Non Locking Molex 51110-0850; Crimp Terminal: Molex p/n 50394. Or Molex 51110-0856, includes Locking Tab & Polarization Keying

J4: M4 Screw

J4 (Type A): M4 Screw (8mm)

J4 (Type B) Connector(s): Camden CTB9200/4A

## Input Connectors

Excelsys Modular power supplies have a variety of input connector options to ease system integration. These include IEC, Input cables (3-wire) and IEC to Screw Terminal Adaptor.

### J1 & J2 Connectors 4-slot

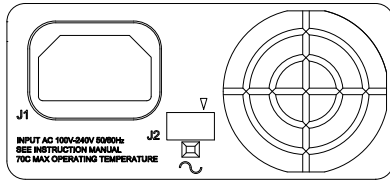

### J1 & J2 Connectors 6-slot

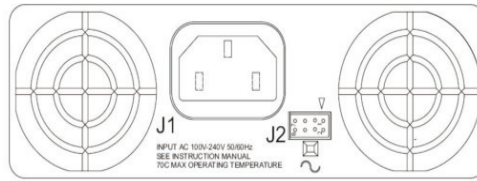

Pin	J1	J2
1	Line	Common
2	Neutral	+5V Bias
3	Earth	not used
4		AC Fail
5		Fan Fail
6		Global Enable
7		Temp Alarm
8		Global Inhibit

## Input Mating Connectors

J1: IEC320 type female plug rated 13, Locking IEC cable and connector: Schaffner EMC part number IL13-US1-SVT-3100-183.

J2: Locking Molex 51110-0860; Non Locking 51110-0850; Crimp Terminal: Molex p/n 50394; Or Molex 51110-0856, includes Locking Tab & Polarization Keying

## Input Cable (Option D)

Excelsys modular power supplies are also available with an input cable connection option allowing greater flexibility when mounting the power supply in the system. Individually insulated input cables are 300mm in length and come supplied with Faston connectors.

## XCE and XVE PowerPac considerations

1. XCE and XVE can deliver 1450W for a duration of 10s with an 8% duty cycle.
2. When 6 *powerMods* are operated in parallel, the XCE output power must be derated to 1280W.
3. At operation above 40°C, it is necessary to apply minimum load to the outputs. See table for minimum load requirements.

T ambient (°C)	Min Load (W)
40	0
50	100
60	175
70	250

## XVC/XVE minimum load requirements



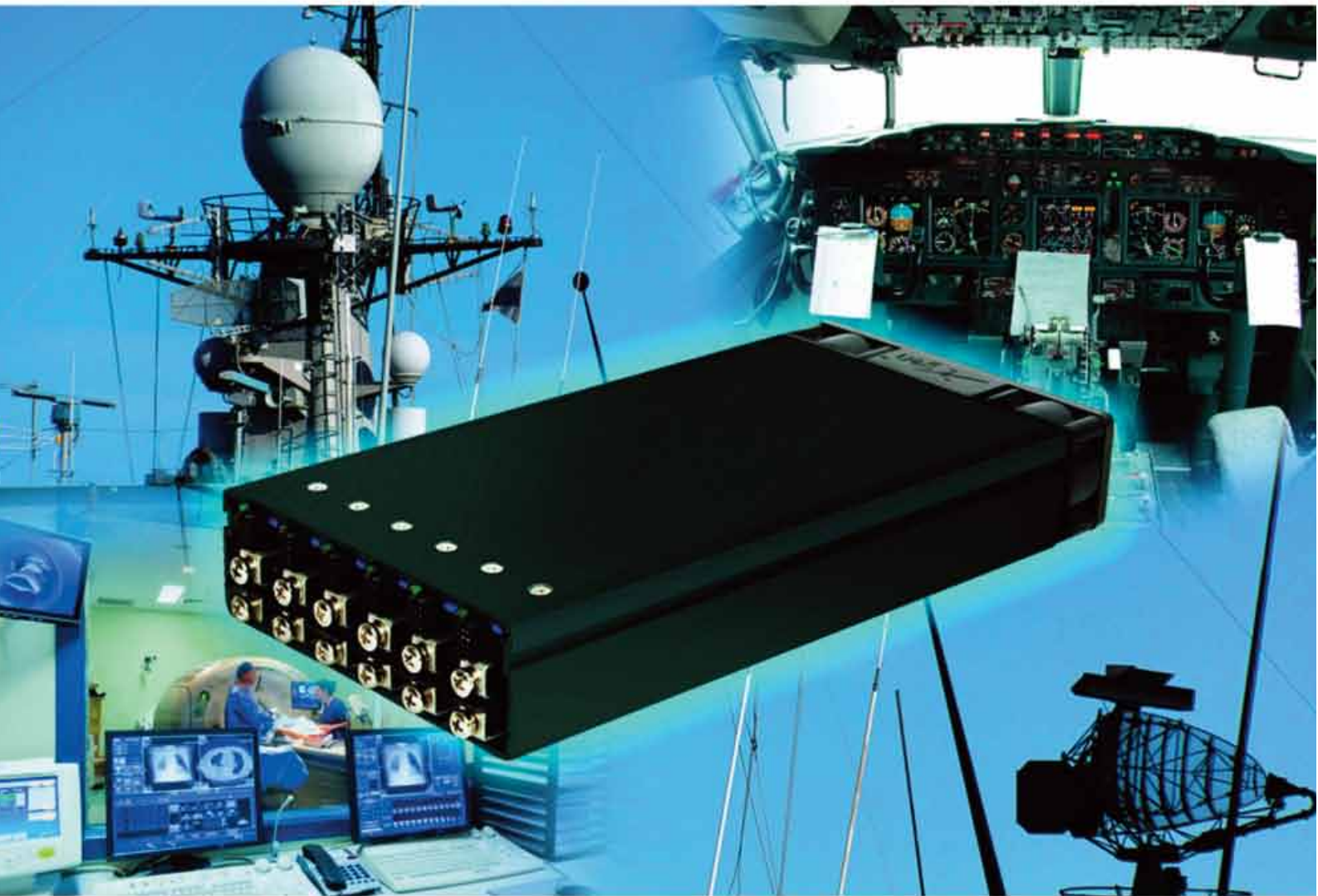

## **F Series**

**The Modular Power Solution of Choice  
for Hi Rel & Mil-COTS Applications.**

- *Highest Reliability, Efficiency, Power Density*
- *MIL810G & MIL461*
- *-55 °C to 70 °C Operating temperature*
- *47-440Hz Input Frequency*



## Ruggedised COTS AC/DC Power Supply

Ultra-high efficiency 1U size

**PLUG & PLAY POWER**  
next generation power source

### FEATURES

- MIL-STD-810G: Shock & Vibration
- MIL-STD-461F (CE101 & CE102) : EMC
- Conformal Coated & Ruggedised as standard
- Operating temperature range of -55/-40 to 70°C
- 47-440Hz input frequency
- Anti-Vibration Compound
- 1.15V to 58V standard output voltages
- All outputs fully floating
- Extra low profile: 1U height (40mm)
- Ultra high efficiency, up to 90%
- Plug & Play Power
  - allows fast custom configuration
  - Outputs completely field configurable with option to factory fix
- Series / Parallel outputs for higher voltages and currents
- Parallel powerpacs for higher power
- OVP, OTP, OCP as standard
- 5V/250mA bias standby voltage provided
- Individual output control
- 5 Year Warranty
- SEMI F47 Compliant
- Active PFC (Power Factor Correction)

### APPLICATIONS INCLUDE

- Harsh Industrial Electronics
- Radar (Naval, Ground Based)
- Communications
- Test & Measurement

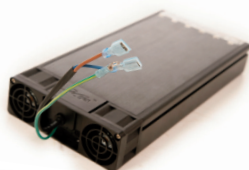

The XF family of power supplies provides up to an incredible 1000W in an extremely compact 1U x 268 x 127mm package. Employing an innovative plug & play architecture the XF family brings unprecedented flexibility that allows users to instantly configure a custom power solution in less than 5 minutes.

Designed for use in harsh operating environments, the XF family is conformal coated and ruggedised to withstand extremes in shock and vibration as well as operation over a wide temperature range of -55 to 70°C. Applications include Harsh Industrial, Test and Measurement, Communications, Fixed and Mobile Radar and Military Electronics which require COTS solutions.

All configurations carry full safety agency approvals, including UL60950 and EN60950 and are fully characterised for EMC according to MIL-STD-461F. All configurations meet the MIL-STD-810G standard for shock and vibration. EMC characterisation, Shock and Vibration and Thermal Stress reports are available.

For further details please contact [support@excelsys.com](mailto:support@excelsys.com).

#### powerPacs

	PowerPac	Power	PowerMod Slots	Operating Temperature	MIL-STD-461F	MIL-STD-810G	Conformal Coating
Hi-Rel COTS	XFA	400W	6	-55 to 70°C	Yes	Yes	Yes
	XFB	700W	6	-55 to 70°C	Yes	Yes	Yes
	XFC	1000W	6	-55 to 70°C	Yes	Yes	Yes
	XFN	1000W	6	-40 to 70°C	Yes	Yes	Yes

#### powerMods

Model	Vnom (V)	Set Point Adjust Range (V)	Dynamic Vtrim Range (V)	I <sub>max</sub> (A)	Power (W)	Remote Sense	Power Good
XgA	12.0	10.8-15.6	-	12.5	150	-	-
XgB	24.0	19.2-26.4	-	8.3	200	-	-
XgC	36.0	28.8-39.6	-	5.6	200	-	-
XgD	48.0	38.5-50.4	-	4.2	200	-	-
XgE/Xg7	24.0	5.0-28.0	-	5.0	120	-	Yes
XgF/Xg8	24.0	5.0-28.0	-	3.0	72	-	Yes
	24.0	5.0-28.0	-	3.0	72	-	Yes
XgG	2.5	1.5-3.6	1.15-3.6	40.0	100	Yes	Yes
XgH	5.0	3.2-6.0	1.5-6.0	36.0	180	Yes	Yes
XgJ	12.0	6.0-15.0	4.0-15.0	18.3	220	Yes	Yes
XgK	24.0	12.0-30.0	8.0-30.0	9.2	220	Yes	Yes
XgL	48.0	28.0-58.0	8.0-58.0	5.0	240	Yes	Yes
Xg1	2.5	1.5-3.6	1.15-3.6	50.0	125	Yes	Yes
Xg2	5.0	3.2-6.0	1.5-6.0	40.0	200	Yes	Yes
Xg3	12.0	6.0-15.0	4.0-15.0	20.0	240	Yes	Yes
Xg4	24.0	12.0-30.0	8.0-30.0	10.0	240	Yes	Yes
Xg5	48.0	28.0-58.0	8.0-58.0	6.0	288	Yes	Yes

\*When ordering individual *powerMods* for use with the XF Series add the suffix C for conformal coating.

See our new Wide Trim *powerMods* on page 40 and Reactive Load *powerMods* on page 42.

INPUT					
Parameter	Conditions/Description	Min	Nom	Max	Units
Input Voltage Range	Input Frequency: 47 - 63Hz. Input Frequency: 47 - 440Hz.	85		264	VAC
		90		120	VAC
		120		380	VDC
Power Rating	XFA			400	W
	XFB			700	W
	XFC			1000	W
	XFN			1000	W
Input Current	XFA	85VAC in 400W out	7.5		A
	XFB	85VAC in 700W out	9.5		A
	XFC	85VAC in 765W out	11.5		A
	XFN	85VAC in 765W out	11.5		A
Inrush Current	230VAC @ 25°C			25	A
Undervoltage Lockout	Shutdown	65		74	VAC
Power Factor	110 VAC @ Full Load	0.98	0.99		
Fusing	XFA	250V		F8A HRC	
	XFB	250V		F10A HRC	
	XFC	250V		F12A HRC	
	XFN	250V		F12AHRC	
OUTPUT					
Parameter	Conditions/Description	Min	Nom	Max	Units
<i>powerMod</i> Power	As per <i>powerMod</i> table				
Output Adjustment Range	Manual or Electronic As per <i>powerMod</i> Table				
Minimum Load			0		A
Line Regulation	For ±10% change from nominal line			±0.1	%
Load & Cross Regulation	For 25% to 75% load change			±0.2	%
Transient Response	For 25% to 75% load change	Voltage Deviation		10	%
				Settling Time	250
Ripple and Noise	20MHz Bandwidth 100mv or 1.0% pk-pk				
Overvoltage Protection	Vmax (Latching)	105		170	%
Overcurrent Protection	Straight line with hiccup activation at <30% of Vnom	105		170	%
Remote Sense	Max. line drop compensation. (See <i>powerMod</i> table on page 18)			0.5	VDC
Overshoot				2	%
Turn-on Delay	From AC In / <i>powerMod</i> Enable signal			1000 /6	ms
Rise Time	Monotonic			5	ms
Hold-up Time	For nominal output voltages at full load.	20			ms
Output Isolation	Output to Output / Output to Chassis	500 / 500			VDC
GENERAL					
Parameter	Conditions/Description	Min	Nom	Max	Units
Isolation Voltage	Primary to Secondary Input to Chassis	3000			VAC
		1500			VAC
Efficiency	230VAC, 1000W @ 24V		90		%
Safety Agency Approvals	EN60950, UL60950, CSA22.2 No.950 UL File No. E181875				
Earth Leakage Current	230VAC, 50Hz, 25°C			1.5	mA
Bias Supply	Always ON. Current 250mA	4.8	5.0	5.5	VDC
Weight	PowerPac		1.2		kg
	Typical <i>PowerMod</i>		0.1		kg
Reliability	Telcordia SR-332 at 25°C and full load	<i>powerMod</i>		1020	kh
	Telcordia SR-332 at 25°C and full load	<i>powerPac</i> (excludes fans)		1057	kh
	MIL-STD-217F at 25°C and full load	<i>powerMod</i>		86	kh
	MIL-STD-217F at 25°C and full load	<i>powerPac</i> (excludes fans)		77	kh
EMC					
Parameter	Standard	Level		Units	
Emissions					
Conducted	EN55011, EN55022, FCC: Class B		Compliant		
Radiated	EN55011, EN55022, FCC: Class B		Compliant		
Harmonic Distortion	EN61000-3-2 Class A & MIL-STD-1399 SECTION 300A		Compliant		
Flicker and Fluctuation	EN61000-3-3		Compliant		
Immunity					
Electrostatic Discharge	EN61000-4-2: Level 2		Compliant		
Radiated RFI	EN61000-4-4: Level 3 & MIL-STD-461F. See note 6.		Compliant		
Fast Transients - burst	EN61000-4-4: Level 3		Compliant		
Input Line Surges	EN61000-4-5: Level 3 & MIL-STD-1399		Compliant		
Conducted RFI	EN61000-4-6: Level 3 & MIL-STD-461F. See note 6.		Compliant		
Voltage Dips	EN61000-4-11 & MIL-STD-70, SEMI F47 compliant <sup>(7)</sup>		Compliant		
ENVIRONMENTAL					
Parameter	Conditions/Description	Min	Nom	Max	Units
Operating Temperature	XFA, XFB, XFC	-55		+70	°C
	XFN operates to specification below -20°C after 10 min warm-up	-40		+70	°C
Storage Temperature		-55		+75	°C
Derating	See page 20 for full temperature derating				
Acoustic Noise	Measured from distance of 1m; See Page 58 for full table		56.5		dB(A)
Relative Humidity	Non-condensing	5		95	%RH
Shock	3000 Bumps, 10G (16ms) half sine				
Vibration	1.5G : MIL-STD-810G	10		500	Hz
Altitude	Operational: 2000m, Storage: 8000m				

**NOTES**

1. All specifications at nominal input, full load, 25°C unless otherwise stated.
2. This product is not intended for use as a stand alone unit and must be installed by qualified personnel.
3. The specifications contained herein are believed to be correct at time of publication and are subject to change without notice.
4. Derating required below -40 °C.
5. With certain configurations when powering inductive or capacitive loads, it is recommended to use a blocking diode on the output.- consult Excelsys for further detail.
6. An external filter may be required to meet certain conducted and radiated emissions requirements for MIL-STD-461F. For further details contact support@excelsys.com.
7. SEMI F47 compliant at input voltages >160VAC. Consult Excelsys for details.
8. Consult Excelsys for module derating at temperatures from -40°C to -55°C.
9. Product is not UL/EN certified for 120-380VDC input operation. Consult Excelsys for details.

## Output Connectors

The output *powerMods* connection details are shown below. Type A connectors are for single output *powerMods* XgA-XgT and Xg1-Xg7. The Type B connector is for the dual output XgF/Xg8 *powerMod*. The power and signal connectors are as follows:

**Type A: *powerMods***  
XgA to XgE  
XgG to XgT  
Xg1 to Xg7

**Type B: *powerMod***  
XgF/Xg8

## Output Signals and Power Connector Pinout

Pin	J3 Module (XgA to XgD)	J3 (XgG-XgT) (Xg1-Xg5)	J3 (XgE) (Xg7)	J3 (XgF) (Xg8)	J4 (Type A)	J4 (Type B)
1	not used	+Sense*	not used	-pg (V2)	-Vout	-V2
2	Common	-Sense*	not used	+pg (V2)	+Vout	+V2
3	not used	Vtrim	not used	Inhibit (V2)		-V1
4	not used	Itrim	Common	Common (V2)		+V1
5	+Inhibit	+Inhibit/Enable	-pg	-pg (V1)		
6	-Inhibit	-Inhibit/Enable	+pg	+pg (V1)		
7	not used	+pg	Inhibit	Inhibit (V1)		
8	not used	-pg	Common	Common (V1)		

\*remote sense not present on XgR and XgT *powerMods*.

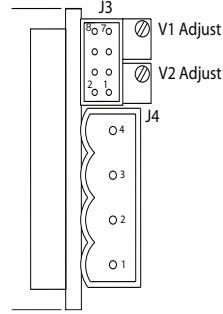
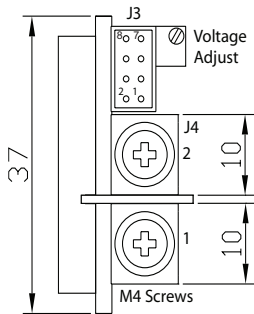

## Output Mating Connectors

J3: Locking Molex 51110-0860; Non Locking Molex 51110-0850; Crimp Terminal: Molex p/n 50394: Or Molex 51110-0856, includes Locking Tab & Polarization Keying

J4 (Type A): M4 Screw (8mm)

J4 (Type B) Connector(s): Camden CTB9200/4A

## Input Connectors

Excelsys Modular power supplies have a variety of input connector options to ease system integration. These include IEC, Input cables (3-wire) and IEC to Screw Terminal Adaptor.

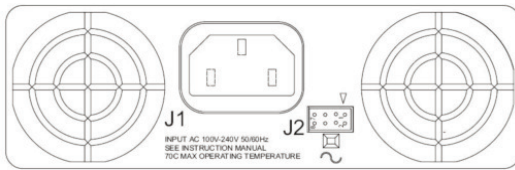

Pin	J1	J2
1	Line	Common
2	Neutral	+5V Bias
3	Earth	not used
4		AC Fail
5		Fan Fail
6		Global Enable
7		Temp Alarm
8		Global Inhibit

## Input Mating Connectors

J1: IEC320 type female plug rated 13, Locking IEC cable and connector: Schaffner EMC part number IL13-US1-SVT-3100-183.

J2: Locking Molex 51110-0860; Non Locking 51110-0850; Crimp Terminal: Molex p/n 50394: Or Molex 51110-0856, includes Locking Tab & Polarization Keying

## Input Cable (Option D)

Excelsys modular power supplies are also available with an input cable connection option allowing greater flexibility when mounting the power supply in the system. Individually insulated input cables are 300mm in length and come supplied with Faston connectors.

## XF Series Derating Curves

Temperature Derating Curve for XF Models

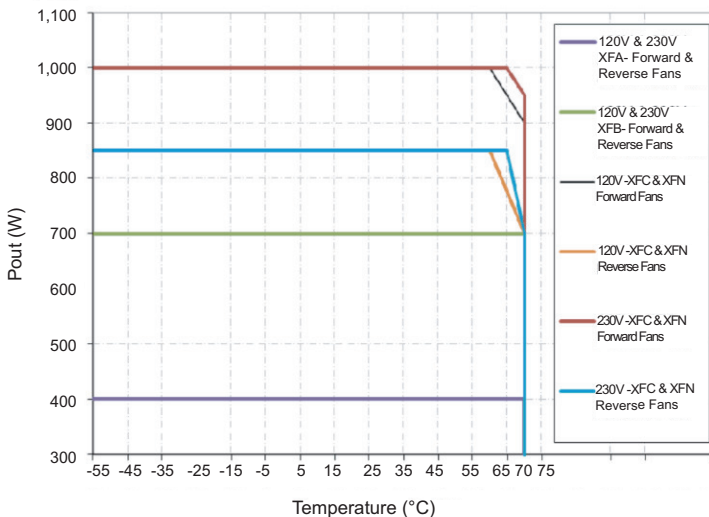

\*XFN Operation from -40°C to 70°C

## XF Series Derating Curves

Line Derating Curve for XF Models (@ 60°C)

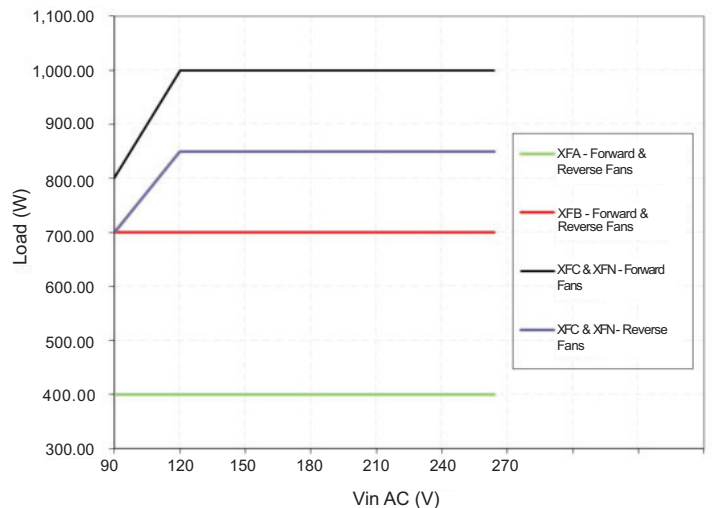



## Xgen Series

*The World's Most Popular  
Modular Power Supply*

- *High Efficiency*
- *High Reliability*
- *High Power Density*



## Slimline Power Supply

User Configurable 1U Size



### PLUG & PLAY POWER next generation power solution

#### FEATURES & OPTIONS

- Ultra high efficiency, up to 89%
- Extra low profile: 1U height (40mm)
- Plug & Play Power - allows fast custom configuration
- Individual output control signals
- All outputs fully floating
- Series / Parallel of multiple outputs
- Few electrolytic capacitors (all long life)
- Visual LED indicators
- 5V bias standby voltage provided
- SEMI F47 Compliant
- Active PFC (Power Factor Correction)
- Standard Xgen product options include: Conformal Coating, Low Acoustic Noise, Low Leakage Current, Extra Ruggedisation, Connector, Cabling & Mounting options, Thermal Signals and Reverse Fans. See Section 4.10 for more information

#### APPLICATIONS INCLUDE

- Industrial machines
- Test and measurement
- Automation equipment
- Printing
- Telecommunications

The XL family of power supplies provides up to 750W in a slimline 1U package. Providing up to 8 isolated outputs, the XL family is the most flexible power supply in its class and brings affordable configurable power to the 200-750W market.

The slimline product boasts unrivalled power density saving valuable system space. Combined with ultra high efficiencies, the XL family provides system designers with flexible instant solutions that significantly shorten design-in time and simplify integration.

The XL family consists of 4 *powerPac* models in 200W, 400W, 600W and 750W power levels. Each *powerPac* model may be populated with up to 4 *powerMods* selected from the table of *powerMods* shown below.

All configurations carry full safety agency approvals, UL60950, EN60950 and are CE marked.

#### powerPacs

	MODEL	Watts
XL	XLA	200W
	XLB	400W
	XLC	600W
	XLD	750W

#### powerMods

Model	Vnom (V)	Set Point Adjust Range (V)	Dynamic Vtrim Range (V)	I <sub>max</sub> (A)	Power (W)	Remote Sense	Power Good
XgA	12.0	10.8-15.6	-	12.5	150	-	-
XgB	24.0	19.2-26.4	-	8.3	200	-	-
XgC	36.0	28.8-39.6	-	5.6	200	-	-
XgD	48.0	38.5-50.4	-	4.2	200	-	-
XgE/Xg7	24.0	5.0-28.0	-	5.0	120	-	Yes
XgF/Xg8	24.0	5.0-28.0	-	3.0	72	-	Yes
	24.0	5.0-28.0	-	3.0	72	-	Yes
XgG	2.5	1.5-3.6	1.15-3.6	40.0	100	Yes	Yes
XgH	5.0	3.2-6.0	1.5-6.0	36.0	180	Yes	Yes
XgJ	12.0	6.0-15.0	4.0-15.0	18.3	220	Yes	Yes
XgK	24.0	12.0-30.0	8.0-30.0	9.2	220	Yes	Yes
XgL	48.0	28.0-58.0	8.0-58.0	5.0	240	Yes	Yes
Xg1	2.5	1.5-3.6	1.15-3.6	50.0	125	Yes	Yes
Xg2	5.0	3.2-6.0	1.5-6.0	40.0	200	Yes	Yes
Xg3	12.0	6.0-15.0	4.0-15.0	20.0	240	Yes	Yes
Xg4	24.0	12.0-30.0	8.0-30.0	10.0	240	Yes	Yes
Xg5	48.0	28.0-58.0	8.0-58.0	6.0	288	Yes	Yes

See our new Wide Trim *powerMods* on page 40 and Reactive Load *powerMods* on page 42.

**SPECIFICATION** applies to configured units consisting of **powerMods** inserted into the appropriate **powerPac**

INPUT					
Parameter	Conditions/Description	Min	Nom	Max	Units
Input Voltage Range	Universal Input 47-440Hz	85 120		264 380	VAC VDC
Power Rating	XLA:200W, XLB:400W, XLC:600W, XLD:750W See Section 3.2 for line voltage deratings				
Input Current	XLA XLB XLC XLD	85VAC in 200W out 85VAC in 400W out 85VAC in 400W out 85VAC in 525W out		4.0 6.0 7.5 7.5	A A A A
Inrush Current	230VAC, 25°C			50	A
Undervoltage Lockout	Shutdown	65		74	VAC
Power Factor	110 VAC @ Full Load	0.98	0.99		
Fusing	XLA XLB XLC, XLD	250V 5 x 20mm 250V 5 x 20mm 250V 5 x 20mm		F5A HRC F6.3A HRC F8A HRC	
OUTPUT					
Parameter	Conditions/Description	Min	Nom	Max	Units
powerMod Power	As per powerMod table				
Output Adjustment Range	Manual: Multi-turn potentiometer. As per powerMod table Electronic: See Section 4.6				
Minimum Load			0		A
Line Regulation	For ±10% change from nominal line			±0.1	%
Load Regulation	For 25% to 75% load change			±0.2	%
Cross Regulation				±0.2	%
Transient Response	For 25% to 75% load change Voltage Deviation Settling Time			10 250	% µs
Ripple and Noise	20MHz 100mV or 1.0% pk-pk				
Overvoltage Protection	1st level: Vset Tracking. 2nd level: Vmax (Latching)	105		170	%
Overcurrent Protection	Straight line with hiccup activation at <30% of Vnom See Section 4.6	105		170	%
Remote Sense	Max. line drop compensation.(except Xg7, Xg8, XgE, XgF, XgR, XgT)			0.5	VDC
Overshoot				2	%
Turn-on Delay	From AC In and Global Enable / powerMod Enable XLA, XLB, XLC From AC In and Global Enable / powerMod Enable XLD			700 / 6 1000 / 6	ms ms
Rise Time	Monotonic			5	ms
Hold-up Time	For nominal output voltages at full load XLA, XLB, XLC/XLD	20/15			ms
Output Isolation	Output to Output / Output to Chassis	500 / 500			VDC
GENERAL					
Parameter	Conditions/Description	Min	Nom	Max	Units
Isolation Voltage	Input to Output Input to Chassis	3000 1500			VAC VAC
Efficiency	230VAC, 750W @ 24V		89		%
Safety Agency Approvals	EN60950, UL60950, CSA22.2 No.950 UL File No. E181875				
Leakage Current	250VAC, 60Hz, 25°C			1.5	mA
Weight	See weight calculators on Excelsys website				
Signals	See Section 4.9				
Bias Supply	Always on. Current 500mA.	4.8	5.0	5.2	VDC
Reliability	Failures per million hours at 40°C and full load powerMod See Section 7.1 . powerPac excludes fans powerPac			0.958 0.92	fpmh fpmh
EMC					
Parameter	Standard		Level		Units
Emissions					
Conducted	EN55011, EN55022, FCC		Class B		
Radiated	EN55011, EN55022, FCC		Class B		
Harmonic Distortion	EN61000-3-2 Class A		Compliant		
Flicker & Fluctuation	EN61000-3-3		Compliant		
Immunity					
Electrostatic Discharge	EN61000-4-2		Level 2		
Radiated Immunity	EN61000-4-3		Level 3		
Fast Transients-Burst	EN61000-4-4		Level 3		
Input Line Surges	EN61000-4-5		Level 3		
Conducted Immunity	EN61000-4-6		Level 3		
Voltage Dips	EN61000-4-11, SEMI F47 compliant <sup>(8)</sup>		Compliant		
ENVIRONMENTAL					
Parameter	Conditions/Description	Min	Nom	Max	Units
Operating Temperature		-20		+70	°C
Storage Temperature		-40		+85	°C
Derating	See Section 3.2 for full temperature deratings				
Relative Humidity	Non-condensing	5		95	%RH
Acoustic Noise	Measured from distance of 1m; See Page 58 for full table		45.8		dBA
Shock	3000 Bumps, 10G (16ms) half sine				
Vibration	1.5G	10		200	Hz
Altitude	Operational: 2000m, Storage: 8000m				

**NOTES**

1. This product is not intended for use as a stand alone unit and must be installed by qualified personnel.
2. The specifications contained herein are believed to be correct at time of publication and are subject to change without notice.
3. All specifications at nominal input, full load, 25°C unless otherwise stated.
4. XLD: 800W peak for 1s; Duty cycle 7%. powerMod output power must not exceed normal ratings.
5. When powering inductive or capacitive loads, it is recommended to use a blocking diode on the output.
6. Conformal Coating option: See Sections 3.4 and 4.10 for details.
7. For section references above go to the Designers Manual.
8. SEMI F47 compliant at input voltages >160VAC. Consult Excelsys for details.
9. Visit [www.excelsys.com](http://www.excelsys.com) for configuration and ordering and contact information.
10. Product is not UL/EN certified for 120-380VDC input operation. Consult Excelsys for details.



## Medical Power Supply

User Configurable 1U size



### PLUG & PLAY POWER next generation power solution

#### FEATURES & OPTIONS

- EN60601-1 3rd edition approved
- Less than 300µA leakage current
- 150µA option available
- 4000VAC isolation
- Ultra high efficiency, up to 89%
- Extra low profile: 1U height (40mm)
- Plug & Play Power - allows fast custom configuration
- Individual output control signals
- All outputs fully floating
- Series / Parallel of multiple outputs
- Few electrolytic capacitors (all long life)
- 5V bias standby voltage provided
- Active PFC (Power Factor Correction)
- Standard Xgen product options include: Conformal Coating, Low Acoustic Noise, Low Leakage Current, Extra Ruggedisation, Connector, Cabling & Mounting options, Thermal Signals and Reverse Fans. See Section 4.10 for more information

#### APPLICATIONS INCLUDE

- Radiological imaging
- Clinical diagnostics
- Medical lasers
- Clinical chemistry

The XM family of medically approved power supplies provides up to 750W in a slimline 1U package. The XM family carries the latest safety agency approvals to EN60601-1 and UL60601-1 3rd Edition, meeting the stringent creepage and clearance requirements in this compact package. Providing up to 8 isolated outputs, the XM family is the most flexible power supply in its class and brings affordable configurable power to the 200-750W medical market.

The XM family consists of 4 *powerPac* models in 200W, 400W, 600W and 750W power levels. Each *powerPac* model may be populated with up to 4 *powerMods* selected from the table of *powerMods* shown below. Simply select your appropriate *powerPac* and *powerMods* to get your instant custom power solution.

This slimline product boasts unrivalled power density, providing significant system space savings. Combined with ultra-high efficiencies, the XM family provides system designers with flexible instant solutions that significantly shorten system design-in time.

#### powerPacs

	MODEL	Watts
XM	XMA	200W
	XMB	400W
	XMC	600W
	XMD	750W

#### powerMods

Model	Vnom (V)	Set Point Adjust Range (V)	Dynamic Vtrim Range (V)	I <sub>max</sub> (A)	Power (W)	Remote Sense	Power Good
XgA	12.0	10.8-15.6	-	12.5	150	-	-
XgB	24.0	19.2-26.4	-	8.3	200	-	-
XgC	36.0	28.8-39.6	-	5.6	200	-	-
XgD	48.0	38.5-50.4	-	4.2	200	-	-
XgE/Xg7	24.0	5.0-28.0	-	5.0	120	-	Yes
XgF/Xg8	24.0	5.0-28.0	-	3.0	72	-	Yes
	24.0	5.0-28.0	-	3.0	72	-	Yes
XgG	2.5	1.5-3.6	1.15-3.6	40.0	100	Yes	Yes
XgH	5.0	3.2-6.0	1.5-6.0	36.0	180	Yes	Yes
XgJ	12.0	6.0-15.0	4.0-15.0	18.3	220	Yes	Yes
XgK	24.0	12.0-30.0	8.0-30.0	9.2	220	Yes	Yes
XgL	48.0	28.0-58.0	8.0-58.0	5.0	240	Yes	Yes
Xg1	2.5	1.5-3.6	1.15-3.6	50.0	125	Yes	Yes
Xg2	5.0	3.2-6.0	1.5-6.0	40.0	200	Yes	Yes
Xg3	12.0	6.0-15.0	4.0-15.0	20.0	240	Yes	Yes
Xg4	24.0	12.0-30.0	8.0-30.0	10.0	240	Yes	Yes
Xg5	48.0	28.0-58.0	8.0-58.0	6.0	288	Yes	Yes

See our new Wide Trim *powerMods* on page 40 and Reactive Load *powerMods* on page 42.



**SPECIFICATION** applies to configured units consisting of *powerMods* plugged into the appropriate *powerPac*

INPUT					
Parameter	Conditions/Description	Min	Nom	Max	Units
Input Voltage Range	Universal Input 47-440Hz	85		264	VAC
		120		380	VDC
Power Rating	XMA:200W, XMB:400W, XMC:600W, XMD:750W See Section 3.2 for line voltage deratings				
Input Current	XMA	85VAC in	200W out	4.0	A
	XMB	85VAC in	400W out	6.0	A
	XMC	85VAC in	400W out	7.5	A
	XMD	85VAC in	525W out	7.5	A
Inrush Current	230VAC, 25°C			50	A
Undervoltage Lockout	Shutdown	65		74	VAC
Power Factor	110 VAC @ Full Load	0.98	0.99		
Fusing	XMA	250V	5 x 20mm	F5A HRC	
	XMB	250V	5 x 20mm	F6.3A HRC	
	XMC, XMD	250V	5 x 20mm	F8A HRC	
OUTPUT					
Parameter	Conditions/Description	Min	Nom	Max	Units
<i>powerMod</i> Power	As per <i>powerMod</i> table				
Output Adjustment Range	Manual: Multi-turn potentiometer. As per <i>powerMod</i> table Electronic: See Section 4.6				
Minimum Load			0		A
Line Regulation	For ±10% change from nominal line			±0.1	%
Load Regulation	For 25% to 75% load change			±0.2	%
Cross Regulation				±0.2	%
Transient Response	For 25% to 75% load change Voltage Deviation Settling Time			10	%
				250	µs
Ripple and Noise	20MHz 100mV or 1.0% pk-pk				
Overvoltage Protection	1st level: Vset Tracking. 2nd level: Vmax (Latching)	105		170	%
Overcurrent Protection	Straight line with hiccup activation at <30% of Vnom See Section 4.6	105		170	%
Remote Sense	Max. line drop compensation.(except Xg7, Xg8, XgE, XgF, XgR, XgT)			0.5	VDC
Overshoot				2	%
Turn-on Delay	From AC in and Global Enable / <i>powerMod</i> Enable XMA, XMB, XMC			700 / 6	ms
	From AC in and Global Enable / <i>powerMod</i> Enable XMD			1000 / 6	ms
Rise Time	Monotonic			5	ms
Hold-up Time	For nominal output voltages at full load XMA,XMB, XMC/XMD	20/15			ms
Output Isolation	Output to Output / Output to Chassis	500 / 500			VDC
GENERAL					
Parameter	Conditions/Description	Min	Nom	Max	Units
Isolation Voltage	Input to Output	4000			VAC
	Input to Chassis	1500			VAC
Efficiency	230VAC, 750W @ 24V		89		%
Safety Agency Approvals	EN60601-1, UL60601-1 3rd Edition, CSA601-1 UL File no. E230761				
Leakage Current	250VAC, 60Hz, 25°C			300	µA
	250VAC, 60Hz, 25°C Option 04			150	µA
Weight	See weight calculators on Excelsys website				
Signals	See Section 4.9				
Bias Supply	Always on. Current 500mA.	4.8	5.0	5.2	VDC
Reliability	Failures per million hours at 40°C and full load <i>powerMod</i>			0.958	fpmh
	See Section 7.1 . <i>powerPac</i> excludes fans <i>powerPac</i>			0.92	fpmh
EMC					
Parameter	Standard	Level			Units
<b>Emissions</b>					
Conducted	EN55011, EN55022, FCC		Class B		
Radiated	EN55011, EN55022, FCC		Class B		
Harmonic Distortion	EN61000-3-2 Class A		Compliant		
Flicker & Fluctuation	EN61000-3-3		Compliant		
<b>Immunity</b>					
Electrostatic Discharge	EN61000-4-2		Level 2		
Radiated Immunity	EN61000-4-3		Level 3		
Fast Transients-Burst	EN61000-4-4		Level 3		
Input Line Surges	EN61000-4-5		Level 3		
Conducted Immunity	EN61000-4-6		Level 3		
Voltage Dips	EN61000-4-11, SEMI F47 Compliant (7)		Compliant		
ENVIRONMENTAL					
Parameter	Conditions/Description	Min	Nom	Max	Units
Operating Temperature		-20		+70	°C
Storage Temperature		-40		+85	°C
Derating	See Section 3.2 for full temperature deratings				
Relative Humidity	Non-condensing	5		95	%RH
Acoustic Noise	Measured from distance of 1m; See Page 58 for full table		45.8		dBA
Shock	3000 Bumps, 10G (16ms) half sine				
Vibration	1.5G				
Altitude	Operational: 2000m, Storage: 8000m				

**NOTES**

1. This product is not intended for use as a stand alone unit and must be installed by qualified personnel.
2. The specifications contained herein are believed to be correct at time of publication and are subject to change without notice.
3. All specifications at nominal input, full load, 25°C unless otherwise stated.
4. XMD: 800W peak for 1s; Duty cycle 7%. *powerMod* output power must not exceed normal ratings.
5. When powering inductive or capacitive loads, it is recommended to use a blocking diode on the output.
6. For section references above go to the Modular Power Supplies Designers Manual.
7. SEMI F47 compliant at input voltages >160VAC. Consult Excelsys for details.
8. Product is not UL/EN certified for 120-380VDC input operation. Consult Excelsys for details.



## Slimline Power Supply

User Configurable 1U size



### PLUG & PLAY POWER next generation power solution

#### FEATURES & OPTIONS

- Low Acoustic noise 39.8dBA
- Ultra high efficiency, up to 89%
- Extra low profile: 1U height (40mm)
- Plug & Play Power - allows fast custom configuration
- Individual output control signals
- All outputs fully floating
- Series / Parallel of multiple outputs
- Few electrolytic capacitors (all long life)
- Visual LED indicators
- 5V bias standby voltage provided
- SEMI F47 Compliant
- Active PFC (Power Factor Correction)
- Standard Xgen product options include: Conformal Coating, Low Acoustic Noise, Low Leakage Current, Extra Ruggedisation, Connector, Cabling & Mounting options, Thermal Signals and Reverse Fans. See Section 4.10 for more information

#### APPLICATIONS INCLUDE

- Audio Equipment
- Test and measurement
- Telecommunications

The XK family of low acoustic noise power supplies provides up to 600W in a slimline 1U x 260mm x 89mm package. Providing up to 8 isolated outputs, the XK family is the most flexible power supply in its class and brings affordable configurable power to the 200-600W market.

Ideal for acoustic sensitive applications, the XK boasts unrivalled power density saving valuable system space. Combine with ultra high efficiencies, the XK family provides system designers with flexible instant solutions that significantly shorten and simplify system design-in time.

The XK family consists of 3 *powerPac* models in 200W, 400W and 600W power levels. Each *powerPac* model may be populated with up to 4 *powerMods* selected from the table of *powerMods* shown below.

All configurations carry full safety agency approvals, UL60950, EN60950 and are CE marked.

#### powerPacs

	MODEL	Watts
	XKA	200W
	XKB	400W
	XKC	600W

#### powerMods

Model	Vnom (V)	Set Point Adjust Range (V)	Dynamic Vtrim Range (V)	I <sub>max</sub> (A)	Power (W)	Remote Sense	Power Good
XgA	12.0	10.8-15.6	-	12.5	150	-	-
XgB	24.0	19.2-26.4	-	8.3	200	-	-
XgC	36.0	28.8-39.6	-	5.6	200	-	-
XgD	48.0	38.5-50.4	-	4.2	200	-	-
XgE/Xg7	24.0	5.0-28.0	-	5.0	120	-	Yes
XgF/Xg8	24.0	5.0-28.0	-	3.0	72	-	Yes
	24.0	5.0-28.0	-	3.0	72	-	Yes
XgG	2.5	1.5-3.6	1.15-3.6	40.0	100	Yes	Yes
XgH	5.0	3.2-6.0	1.5-6.0	36.0	180	Yes	Yes
XgJ	12.0	6.0-15.0	4.0-15.0	18.3	220	Yes	Yes
XgK	24.0	12.0-30.0	8.0-30.0	9.2	220	Yes	Yes
XgL	48.0	28.0-58.0	8.0-58.0	5.0	240	Yes	Yes
Xg1	2.5	1.5-3.6	1.15-3.6	50.0	125	Yes	Yes
Xg2	5.0	3.2-6.0	1.5-6.0	40.0	200	Yes	Yes
Xg3	12.0	6.0-15.0	4.0-15.0	20.0	240	Yes	Yes
Xg4	24.0	12.0-30.0	8.0-30.0	10.0	240	Yes	Yes
Xg5	48.0	28.0-58.0	8.0-58.0	6.0	288	Yes	Yes

See our new Wide Trim *powerMods* on page 40 and Reactive Load *powerMods* on page 42.

**SPECIFICATION** applies to configured units consisting of *powerMods* plugged into the appropriate *powerPac*

INPUT					
Parameter	Conditions/Description	Min	Nom	Max	Units
Input Voltage Range	Universal Input 47-440Hz	85 120		264 380	VAC VDC
Power Rating	XKA:200W, XKB:400W, XKC:600W See Section 3.2 for line voltage deratings				
Input Current XKA XKB XKC	85VAC in 200W out 85VAC in 400W out 85VAC in 400W out		4.5 5.5 7.5		A A A
Inrush Current	230VAC, 25°C			50	A
Undervoltage Lockout	Shutdown	65		74	VAC
Power Factor	110 VAC @ Full Load	0.98	0.99		
Fusing XKA XKB XKC	250V 5 x 20mm 250V 5 x 20mm 250V 5 x 20mm		F5A HRC F6.3A HRC F8A HRC		
OUTPUT					
Parameter	Conditions/Description	Min	Nom	Max	Units
<i>powerMod</i> Power	As per <i>powerMod</i> table				
Output Adjustment Range	Manual: Multi-turn potentiometer. As per <i>powerMod</i> table Electronic: See Section 4.6				
Minimum Load			0		A
Line Regulation	For ±10% change from nominal line			±0.1	%
Load Regulation	For 25% to 75% load change			±0.2	%
Cross Regulation				±0.2	%
Transient Response	For 25% to 75% load change Voltage Deviation Settling Time			10 250	% µs
Ripple and Noise	20MHz 100mV or 1.0% pk-pk				
Overvoltage Protection	Two-level. 1st level: Vset Tracking. 2nd level: Vmax (Latching)	105		170	%
Overcurrent Protection	Straight line with hiccup activation at <30% of Vnom See Section 4.6	105		170	%
Remote Sense	Max. line drop compensation. (except Xg7, Xg8, XgE, XgF, XgR, XgT)			0.5	VDC
Overshoot				2	%
Turn-on Delay	From AC in and Global Enable / <i>powerMod</i> Enable			700 / 6	ms
Rise Time	Monotonic			5	ms
Hold-up Time	For nominal output voltages at full load	20			ms
Output Isolation	Output to Output / Output to Chassis	500 / 500			VDC
GENERAL					
Parameter	Conditions/Description	Min	Nom	Max	Units
Isolation Voltage	Input to Output Input to Chassis	3000 1500			VAC VAC
Efficiency	230VAC, 600W @ 24V		89		%
Safety Agency Approvals	EN60950, UL60950, CSA22.2 No.950 UL File No. E181875				
Leakage Current	250VAC, 60Hz, 25°C			1.5	mA
Weight	See weight calculators on Excelsys website				
Signals	See Section 4.9				
Bias Supply	Always on. Current 500mA.	4.8	5.0	5.2	VDC
Reliability	Failures per million hours at 40°C and full load <i>powerMod</i> See Section 7.1 . <i>powerPac</i> excludes fans <i>powerPac</i>			0.958 0.92	fpmh fpmh
EMC					
Parameter	Standard	Level		Units	
<b>Emissions</b>					
Conducted	EN55011, EN55022, FCC		Class B		
Radiated	EN55011, EN55022, FCC		Class B		
Harmonic Distortion	EN61000-3-2 Class A		Compliant		
Flicker & Fluctuation	EN61000-3-3		Compliant		
<b>Immunity</b>					
Electrostatic Discharge	EN61000-4-2		Level 2		
Radiated Immunity	EN61000-4-3		Level 3		
Fast Transients-Burst	EN61000-4-4		Level 3		
Input Line Surges	EN61000-4-5		Level 3		
Conducted Immunity	EN61000-4-6		Level 3		
Voltage Dips	EN61000-4-11, SEMI F47 compliant <sup>(7)</sup>		Compliant		
ENVIRONMENTAL					
Parameter	Conditions/Description	Min	Nom	Max	Units
Operating Temperature		-20		+70	°C
Storage Temperature		-40		+85	°C
Derating	See Section 3.2 for full temperature deratings				
Relative Humidity	Non-condensing	5		95	%RH
Acoustic Noise	Measured from distance of 1m. See Page 58 for full table		39.8		dBA
Shock	3000 Bumps, 10G (16ms) half sine				
Vibration	1.5G	10		200	Hz
Altitude	Operational: 2000m, Storage: 8000m				

- NOTES**
1. This product is not intended for use as a stand alone unit and must be installed by qualified personnel.
  2. The specifications contained herein are believed to be correct at time of publication and are subject to change without notice.
  3. All specifications at nominal input, full load, 25°C unless otherwise stated.
  4. When powering inductive or capacitive loads, it is recommended to use a blocking diode on the output.
  5. Conformal Coating option: See Sections 3.4 and 4.10 for details.
  6. For section references above go to the Modular Power Supplies Designers Manual.
  7. SEMI F47 compliant at input voltages >160VAC. Consult Excelsys for details.
  8. Visit [www.excelsys.com](http://www.excelsys.com) for configuration and ordering and contact information.
  9. Product is not UL/EN certified for 120-380VDC input operation. Consult Excelsys for details.



**Medical Power Supply**  
Low Acoustic Noise 1U size



**PLUG & PLAY POWER**  
next generation power solution

**FEATURES & OPTIONS**

- Low Acoustic noise 39.8dBA
- EN60601-1 3rd edition approved
- Less than 300µA leakage current
- 150µA option available
- 4000VAC isolation
- Ultra high efficiency, up to 89%
- Extra low profile: 1U height (40mm)
- Plug & Play Power - allows fast custom configuration
- Individual output control signals
- All outputs fully floating
- Series / Parallel of multiple outputs
- Few electrolytic capacitors (all long life)
- 5V bias standby voltage provided
- Active PFC (Power Factor Correction)
- Standard Xgen product options include: Conformal Coating, Low Acoustic Noise, Low Leakage Current, Extra Ruggedisation, Connector, Cabling & Mounting options, Thermal Signals and Reverse Fans. See Section 4.10 for more information

**APPLICATIONS INCLUDE**

- Radiological imaging
- Clinical diagnostics
- Medical lasers
- Clinical chemistry

The XR family of low acoustic noise medically approved power supplies provides up to 600W in a slimline 1u x 260mm x 89mm package. Ideal for acoustic sensitive medical equipment, the XR family carries full safety agency approvals to EN60601-1 and UL60601-1 3rd Edition, meeting the stringent creepage and clearance requirements in this compact package. Providing up to 8 isolated outputs, the XR family is the most flexible power supply in its class and brings affordable configurable power to the 200-600W medical market.

The XR family consists of 3 *powerPac* models in 200W, 400W and 600W power levels. Each *powerPac* model may be populated with up to 4 *powerMods* selected from the table of *powerMods* shown below. Simply select your appropriate *powerPac* and *powerMods* to get your instant custom power solution.

This slimline product boasts unrivalled power density, providing significant system space savings. Combined with ultra-high efficiencies, the XR family provides system designers with flexible instant solutions that significantly shorten system design-in time.

**powerPacs**

	MODEL	Watts
XR	XRA	200W
	XRB	400W
	XRC	600W

**powerMods**

Model	Vnom (V)	Set Point Adjust Range (V)	Dynamic Vtrim Range (V)	I <sub>max</sub> (A)	Power (W)	Remote Sense	Power Good
XgA	12.0	10.8-15.6	-	12.5	150	-	-
XgB	24.0	19.2-26.4	-	8.3	200	-	-
XgC	36.0	28.8-39.6	-	5.6	200	-	-
XgD	48.0	38.5-50.4	-	4.2	200	-	-
XgE/Xg7	24.0	5.0-28.0	-	5.0	120	-	Yes
XgF/Xg8	24.0	5.0-28.0	-	3.0	72	-	Yes
	24.0	5.0-28.0	-	3.0	72	-	Yes
XgG	2.5	1.5-3.6	1.15-3.6	40.0	100	Yes	Yes
XgH	5.0	3.2-6.0	1.5-6.0	36.0	180	Yes	Yes
XgJ	12.0	6.0-15.0	4.0-15.0	18.3	220	Yes	Yes
XgK	24.0	12.0-30.0	8.0-30.0	9.2	220	Yes	Yes
XgL	48.0	28.0-58.0	8.0-58.0	5.0	240	Yes	Yes
Xg1	2.5	1.5-3.6	1.15-3.6	50.0	125	Yes	Yes
Xg2	5.0	3.2-6.0	1.5-6.0	40.0	200	Yes	Yes
Xg3	12.0	6.0-15.0	4.0-15.0	20.0	240	Yes	Yes
Xg4	24.0	12.0-30.0	8.0-30.0	10.0	240	Yes	Yes
Xg5	48.0	28.0-58.0	8.0-58.0	6.0	288	Yes	Yes

See our new Wide Trim *powerMods* on page 40 and Reactive Load *powerMods* on page 42.

**SPECIFICATION** applies to configured units consisting of *powerMods* plugged into the appropriate *powerPac*

INPUT					
Parameter	Conditions/Description	Min	Nom	Max	Units
<b>Input Voltage Range</b>	Universal Input 47-440Hz	85 120		264 380	VAC VDC
<b>Power Rating</b>	XRA:200W, XRB:400W, XRC:600W See Section 3.2 for line voltage deratings				
<b>Input Current</b>	XRA XRB XRC	85VAC in 200W out 85VAC in 400W out 85VAC in 400W out		4.5 5.5 7.5	A A A
<b>Inrush Current</b>	230VAC, 25°C			50	A
<b>Undervoltage Lockout</b>	Shutdown	65		74	VAC
<b>Power Factor</b>	110 VAC @ Full Load	0.98	0.99		
<b>Fusing</b>	XRA XRB XRC	250V 5 x 20mm 250V 5 x 20mm 250V 5 x 20mm		F5A HRC F6.3A HRC F8A HRC	
OUTPUT					
Parameter	Conditions/Description	Min	Nom	Max	Units
<b>powerMod Power</b>	As per <i>powerMod</i> table				
<b>Output Adjustment Range</b>	Manual: Multi-turn potentiometer. As per <i>powerMod</i> table Electronic: See Section 4.6				
<b>Minimum Load</b>			0		A
<b>Line Regulation</b>	For ±10% change from nominal line			±0.1	%
<b>Load Regulation</b>	For 25% to 75% load change			±0.2	%
<b>Cross Regulation</b>				±0.2	%
<b>Transient Response</b>	For 25% to 75% load change			10 Settling Time 250	% µs
<b>Ripple and Noise</b>	20MHz 100mV or 1.0% pk-pk				
<b>Overvoltage Protection</b>	1st level: Vset Tracking. 2nd level: Vmax (Latching)	105		170	%
<b>Overcurrent Protection</b>	Straight line with hiccup activation at <30% of Vnom See Section 4.6	105		170	%
<b>Remote Sense</b>	Max. line drop compensation. (except Xg7, Xg8, XgE, XgF, XgR, XgT)			0.5	VDC
<b>Overshoot</b>				2	%
<b>Turn-on Delay</b>	From AC in and Global Enable / powerMod Enable			700 / 6	ms
<b>Rise Time</b>	Monotonic			5	ms
<b>Hold-up Time</b>	For nominal output voltages at full load	20			ms
<b>Output Isolation</b>	Output to Output / Output to Chassis	500 / 500			VDC
GENERAL					
Parameter	Conditions/Description	Min	Nom	Max	Units
<b>Isolation Voltage</b>	Input to Output Input to Chassis	4000 1500			VAC VAC
<b>Efficiency</b>	230VAC, 600W @ 24V		89		%
<b>Safety Agency Approvals</b>	EN60601-1, UL60601-1 3rd Edition, CSA601-1 UL File no. E230761				
<b>Leakage Current</b>	250VAC, 60Hz, 25°C 250VAC, 60Hz, 25°C Option 04			300 150	µA µA
<b>Weight</b>	See weight calculators on Excelsys website				
<b>Signals</b>	See Section 4.9				
<b>Bias Supply</b>	Always on. Current 500mA.	4.8	5.0	5.2	VDC
<b>Reliability</b>	Failures per million hours at 40°C and full load See Section 7.1. <i>powerPac</i> excludes fans			0.958 0.92	fpmh fpmh
EMC					
Parameter	Standard	Level		Units	
<b>Emissions</b>					
<b>Conducted</b>	EN55011, EN55022, FCC		Class B		
<b>Radiated</b>	EN55011, EN55022, FCC		Class B		
<b>Harmonic Distortion</b>	EN61000-3-2 Class A		Compliant		
<b>Flicker &amp; Fluctuation</b>	EN61000-3-3		Compliant		
<b>Immunity</b>					
<b>Electrostatic Discharge</b>	EN61000-4-2		Level 2		
<b>Radiated Immunity</b>	EN61000-4-3		Level 3		
<b>Fast Transients-Burst</b>	EN61000-4-4		Level 3		
<b>Input Line Surges</b>	EN61000-4-5		Level 3		
<b>Conducted Immunity</b>	EN61000-4-6		Level 3		
<b>Voltage Dips</b>	EN61000-4-11, SEMI F47 Compliant <sup>(6)</sup>		Compliant		
ENVIRONMENTAL					
Parameter	Conditions/Description	Min	Nom	Max	Units
<b>Operating Temperature</b>		-20		+70	°C
<b>Storage Temperature</b>		-40		+85	°C
<b>Derating</b>	See Section 3.2 for full temperature deratings				
<b>Relative Humidity</b>	Non-condensing	5		95	%RH
<b>Acoustic Noise</b>	Measured from distance of 1m. See Page 58 for full table		39.8		dBA
<b>Shock</b>	3000 Bumps, 10G (16ms) half sine				
<b>Vibration</b>	1.5G	10		200	Hz
<b>Altitude</b>	Operational: 2000m, Storage: 8000m				

**NOTES**

1. This product is not intended for use as a stand alone unit and must be installed by qualified personnel.
2. The specifications contained herein are believed to be correct at time of publication and are subject to change without notice.
3. All specifications at nominal input, full load, 25°C unless otherwise stated.
4. When powering inductive or capacitive loads, it is recommended to use a blocking diode on the output.
5. For section references above go to the Modular Power Supplies Designers Manual.
6. SEMI F47 compliant at input voltages >160VAC. Consult Excelsys for details.
7. Visit [www.excelsys.com](http://www.excelsys.com) for configuration and ordering and contact information.
8. Product is not UL/EN certified for 120-380VDC input operation. Consult Excelsys for details.



## AC/DC Power Supply

Ultra-high efficiency 1U size



### PLUG & PLAY POWER next generation power solution

#### FEATURES & OPTIONS

- Ultra high efficiency, up to 90%
- Extra low profile: 1U height (40mm)
- Plug & Play Power - allows fast custom configuration
- Individual output control signals
- All outputs fully floating
- Series / Parallel of multiple outputs
- Few electrolytic capacitors (all long life)
- Visual LED indicators
- 5V bias standby voltage provided
- SEMI F47 Compliant
- Active PFC (Power Factor Correction)
- Standard Xgen product options include: Conformal Coating, Low Acoustic Noise, Low Leakage Current, Extra Ruggedisation, Connector, Cabling & Mounting options, Thermal Signals and Reverse Fans. See Section 4.10 for more information

#### APPLICATIONS INCLUDE

- Industrial machines
- Test and measurement
- Automation equipment
- Printing
- MIL-COTS applications

The XC family of power supplies provides up to 1340W in a slimline 1U package. Providing up to 12 isolated outputs, the XC family is the most flexible power supply in its class and brings affordable configurable power to the 400-1340W market. The slimline product boasts unrivalled power density saving valuable system space.

Combined with ultra high efficiencies, the XC family provides system designers with flexible instant solutions that significantly shorten and simplify system design-in time.

The XC family consists of 5 *powerPac* models in 400W, 700W, 1000W, 1200W and 1340W power levels. Each *powerPac* model may be populated with up to 6 *powerMods* selected from the table of *powerMods* shown below.

All configurations carry full safety agency approvals, UL60950, EN60950 and are CE marked.

#### powerPacs

	MODEL	Watts
XC	XCA	400W
	XCB	700W
	XCC	1000W
	XCD	1200W
	XCE	1340W

#### powerMods

Model	Vnom (V)	Set Point Adjust Range (V)	Dynamic Vtrim Range (V)	I <sub>max</sub> (A)	Power (W)	Remote Sense	Power Good
XgA	12.0	10.8-15.6	-	12.5	150	-	-
XgB	24.0	19.2-26.4	-	8.3	200	-	-
XgC	36.0	28.8-39.6	-	5.6	200	-	-
XgD	48.0	38.5-50.4	-	4.2	200	-	-
XgE/Xg7	24.0	5.0-28.0	-	5.0	120	-	Yes
XgF/Xg8	24.0	5.0-28.0	-	3.0	72	-	Yes
	24.0	5.0-28.0	-	3.0	72	-	Yes
XgG	2.5	1.5-3.6	1.15-3.6	40.0	100	Yes	Yes
XgH	5.0	3.2-6.0	1.5-6.0	36.0	180	Yes	Yes
XgJ	12.0	6.0-15.0	4.0-15.0	18.3	220	Yes	Yes
XgK	24.0	12.0-30.0	8.0-30.0	9.2	220	Yes	Yes
XgL	48.0	28.0-58.0	8.0-58.0	5.0	240	Yes	Yes
Xg1	2.5	1.5-3.6	1.15-3.6	50.0	125	Yes	Yes
Xg2	5.0	3.2-6.0	1.5-6.0	40.0	200	Yes	Yes
Xg3	12.0	6.0-15.0	4.0-15.0	20.0	240	Yes	Yes
Xg4	24.0	12.0-30.0	8.0-30.0	10.0	240	Yes	Yes
Xg5	48.0	28.0-58.0	8.0-58.0	6.0	288	Yes	Yes

See our new Wide Trim *powerMods* on page 40 and Reactive Load *powerMods* on page 42.

**SPECIFICATION** applies to configured units consisting of *powerMods* plugged into the appropriate *powerPac*

INPUT					
Parameter	Conditions/Description	Min	Nom	Max	Units
<b>Input Voltage Range</b>	Universal Input 47-440Hz	85 120		264 380	VAC VDC
<b>Power Rating</b>	XCA:400W, XCB:700W, XCC:1000W, XCD:1200W, XCE:1340W See Section 3.2 for line voltage deratings				
<b>Input Current</b>	XCA XCB XCC, XCD XCE	85VAC in 400W out 85VAC in 700W out 85VAC in 850W out 85VAC in 1000W out	7.5 9.5 11.5 14.0		A A A A
<b>Inrush Current</b>	230VAC @ 25°C			25	A
<b>Undervoltage Lockout</b>	Shutdown	65		74	VAC
<b>Power Factor</b>	110 VAC @ Full Load	0.98	0.99		
<b>Fusing</b>	XCA XCB XCC, XCD XCE	250V 250V 250V 250V		F8A HRC F10A HRC F12A HRC F15A HRC	
OUTPUT					
Parameter	Conditions/Description	Min	Nom	Max	Units
<b>powerMod Power</b>	As per <i>powerMod</i> table				
<b>Output Adjustment Range</b>	Manual: Multi-turn potentiometer. As per <i>powerMod</i> table Electronic: See Section 4.6				
<b>Minimum Load</b>			0		A
<b>Line Regulation</b>	For ±10% change from nominal line			±0.1	%
<b>Load &amp; Cross Regulation</b>	For 25% to 75% load change			±0.2	%
<b>Transient Response</b>	For 25% to 75% load change			10 250	% µs
<b>Ripple and Noise</b>	20MHz 100mV or 1.0% pk-pk				
<b>Overvoltage Protection</b>	Two-level. 1st level: Vset Tracking. 2nd level: Vmax (Latching)	105		170	%
<b>Overcurrent Protection</b>	Straight line with hiccup activation at <30% of Vnom See Section 4.6	105		170	%
<b>Remote Sense</b>	Max. line drop compensation. (except Xg7, Xg8, XgE, XgF, XgR, XgT)			0.5	VDC
<b>Overshoot</b>				2	%
<b>Turn-on Delay</b>	From AC in and Global Enable / powerMod Enable XCA,XCB,XCC,XCD From AC in and Global Enable / powermod Enable XCE			700 / 6 1000 / 6	ms ms
<b>Rise Time</b>	Monotonic			5	ms
<b>Hold-up Time</b>	For nominal output voltages at full load. XCA,XCB,XCC / XCD,XCE	20 / 15			ms
<b>Output Isolation</b>	Output to Output / Output to Chassis	500 / 500			VDC
GENERAL					
Parameter	Conditions/Description	Min	Nom	Max	Units
<b>Isolation Voltage</b>	Input to Output Input to Chassis	3000 1500			VAC VAC
<b>Efficiency</b>	230VAC, 1340W @ 24V		90		%
<b>Safety Agency Approvals</b>	EN60950, UL60950, CSA22.2 No.950 UL File No. E181875				
<b>Earth Leakage Current</b>	250VAC, 60Hz, 25°C			1.5	mA
<b>Weight</b>	See weight calculators on Excelsys website				
<b>Signals</b>	See Section 4.9				
<b>Bias Supply</b>	Always on. Current 500mA (250mA for XCE)	4.8	5.0	5.2	VDC
<b>Reliability</b>	Failures per million hours at 40°C and full load <i>powerMod</i> See Section 7.1 . <i>powerPac</i> excludes fans <i>powerPac</i>			0.958 0.946	fpmh fpmh
EMC					
Parameter	Standard	Level		Units	
<b>Emissions</b>					
<b>Conducted</b>	EN55011, EN55022, FCC		Class B		
<b>Radiated</b>	EN55011, EN55022, FCC		Class B		
<b>Harmonic Distortion</b>	EN61000-3-2 Class A		Compliant		
<b>Flicker &amp; Fluctuation</b>	EN61000-3-3		Compliant		
<b>Immunity</b>					
<b>Electrostatic Discharge</b>	EN61000-4-2		Level 2		
<b>Radiated Immunity</b>	EN61000-4-3		Level 3		
<b>Fast Transients-Burst</b>	EN61000-4-4		Level 3		
<b>Input Line Surges</b>	EN61000-4-5		Level 3		
<b>Conducted Immunity</b>	EN61000-4-6		Level 3		
<b>Voltage Dips</b>	EN61000-4-11, SEMI F47 compliant <sup>(9)</sup>		Compliant		
ENVIRONMENTAL					
Parameter	Conditions/Description	Min	Nom	Max	Units
<b>Operating Temperature</b>		-20		+70	°C
<b>Storage Temperature</b>		-40		+85	°C
<b>Derating</b>	See Section 3.2 for full temperature deratings				
<b>Relative Humidity</b>	Non-condensing	5		95	%RH
<b>Acoustic Noise</b>	Measured from distance of 1m; See Page 58 for full table		49.5		dBA
<b>Shock</b>	3000 Bumps, 10G (16ms) half sine				
<b>Vibration</b>	1.5G	10		200	Hz
<b>Altitude</b>	Operational: 2000m, Storage: 8000m				

**NOTES**

1. This product is not intended for use as a stand alone unit and must be installed by qualified personnel.
2. The specifications contained herein are believed to be correct at time of publication and are subject to change without notice.
3. All specifications at nominal input, full load, 25°C unless otherwise stated.
4. XCE: 1450W peak for 10s; Duty cycle 8%. *powerMod* output power must not exceed normal ratings.
5. When powering inductive or capacitive loads, it is recommended to use a blocking diode on the output.
6. Conformal Coating option: See Sections 3.4 and 4.10 for details.
7. For section references above go to the Modular Power Supplies Designers Manual.
8. SEMI F47 compliant at input voltages >160VAC. Consult Excelsys for details.
9. Product is not UL/EN certified for 120-380VDC input operation. Consult Excelsys for details.



## Medically Approved

Ultra-high efficiency 1U size



### PLUG & PLAY POWER next generation power solution

#### FEATURES & OPTIONS

- EN60601-1 3rd edition approved
- Less than 300µA leakage current
- 150µA option available
- 4000VAC isolation
- Ultra high efficiency, up to 90%
- Extra low profile: 1U height (40mm)
- Plug & Play Power - allows fast custom configuration
- Individual output control signals
- All outputs fully floating
- Series / Parallel of multiple outputs
- Few electrolytic capacitors (all long life)
- 5V bias standby voltage provided
- Active PFC (Power Factor Correction)
- Standard Xgen product options include: Conformal Coating, Low Acoustic Noise, Low Leakage Current, Extra Ruggedisation, Connector, Cabling & Mounting options, Thermal Signals and Reverse Fans. See Section 4.10 for more information

#### APPLICATIONS INCLUDE

- Clinical diagnostic equipment
- Medical lasers
- Dialysis equipment



The XV family of medically approved power supplies provides up to an incredible 1340W in an extremely compact 1U package. Providing up to 12 isolated DC outputs, the XV family employs innovative plug & play architecture allowing users to instantly configure a custom power solution in less than 5 minutes!

The XV family consists of 5 *powerPacs* ranging in power levels from 400W to 1450W peak and 6 *powerMod* DC output modules. Simply select the appropriate *powerPac* and up to 6 *powerMods* from the tables below to complete your custom power supply.

The XV family boasts an industry leading power density of 17W/in<sup>3</sup> and ultra-high efficiencies (up to 90%). The significant system space savings and reduced heat dissipation radically simplify system design.

All configurations carry full safety agency approvals including UL60601-1, EN60601-1 3<sup>rd</sup> Edition and are CE marked.

#### powerPacs

	MODEL	Watts
	XVA	400W
	XVB	700W
	XVC	1000W
	XVD	1200W
	XVE	1340W

#### powerMods

Model	Vnom (V)	Set Point Adjust Range (V)	Dynamic Vtrim Range (V)	I <sub>max</sub> (A)	Power (W)	Remote Sense	Power Good
XgA	12.0	10.8-15.6	-	12.5	150	-	-
XgB	24.0	19.2-26.4	-	8.3	200	-	-
XgC	36.0	28.8-39.6	-	5.6	200	-	-
XgD	48.0	38.5-50.4	-	4.2	200	-	-
XgE/Xg7	24.0	5.0-28.0	-	5.0	120	-	Yes
XgF/Xg8	24.0	5.0-28.0	-	3.0	72	-	Yes
	24.0	5.0-28.0	-	3.0	72	-	Yes
XgG	2.5	1.5-3.6	1.15-3.6	40.0	100	Yes	Yes
XgH	5.0	3.2-6.0	1.5-6.0	36.0	180	Yes	Yes
XgJ	12.0	6.0-15.0	4.0-15.0	18.3	220	Yes	Yes
XgK	24.0	12.0-30.0	8.0-30.0	9.2	220	Yes	Yes
XgL	48.0	28.0-58.0	8.0-58.0	5.0	240	Yes	Yes
Xg1	2.5	1.5-3.6	1.15-3.6	50.0	125	Yes	Yes
Xg2	5.0	3.2-6.0	1.5-6.0	40.0	200	Yes	Yes
Xg3	12.0	6.0-15.0	4.0-15.0	20.0	240	Yes	Yes
Xg4	24.0	12.0-30.0	8.0-30.0	10.0	240	Yes	Yes
Xg5	48.0	28.0-58.0	8.0-58.0	6.0	288	Yes	Yes

See our new Wide Trim *powerMods* on page 40 and Reactive Load *powerMods* on page 42.



INPUT					
Parameter	Conditions/Description	Min	Nom	Max	Units
<b>Input Voltage Range</b>	Universal Input 47-440Hz	85 120		264 380	VAC VDC
<b>Power Rating</b>	XVA:400W, XVB:700W, XVC:1000W, XVD:1200W, XVE:1340W See Section 3.2 for line voltage deratings				
<b>Input Current</b>	XVA XVB XVC, XVD XVE	85VAC in 400W out 85VAC in 700W out 85VAC in 850W out 85VAC in 1000W out	7.5 9.5 11.5 14.0		A A A A
<b>Inrush Current</b>	230VAC @ 25°C			25	A
<b>Undervoltage Lockout</b>	Shutdown	65		74	VAC
<b>Power Factor</b>	110 VAC @ Full Load	0.98	0.99		
<b>Fusing</b>	XVA XVB XVC, XVD XVE	250V 250V 250V 250V		F8A HRC F10A HRC F12A HRC F15A HRC	
OUTPUT					
Parameter	Conditions/Description	Min	Nom	Max	Units
<i>powerMod</i> Power	As per <i>powerMod</i> table				
<b>Output Adjustment Range</b>	Manual: Multi-turn potentiometer. As per <i>powerMod</i> table Electronic: See Section 4.6				
<b>Minimum Load</b>			0		A
<b>Line Regulation</b>	For ±10% change from nominal line			±0.1	%
<b>Load &amp; Cross Regulation</b>	For 25% to 75% load change			±0.2	%
<b>Transient Response</b>	For 25% to 75% load change			10 Settling Time 250	% μs
<b>Ripple and Noise</b>	20MHz 100mV or 1.0% pk-pk				
<b>Overvoltage Protection</b>	Two-level. 1st level: Vset Tracking. 2nd level: Vmax (Latching)	105		170	%
<b>Overcurrent Protection</b>	Straight line with hiccup activation at <30% of Vnom See Section 4.6	105		170	%
<b>Remote Sense</b>	Max. line drop compensation. (except Xg7, Xg8, XgE, XgF, XgR, XgT)			0.5	VDC
<b>Overshoot</b>				2	%
<b>Turn-on Delay</b>	From AC in and Global Enable / <i>powerMod</i> Enable XVA,XVB,XVC,XVD From AC in and Global Enable / <i>powerMod</i> Enable XVE			700 / 6 1000 / 6	ms ms
<b>Rise Time</b>	Monotonic			5	ms
<b>Hold-up Time</b>	For nominal output voltages at full load. XVA,XVB,XVC / XVD,XVE	20 / 15			ms
<b>Output Isolation</b>	Output to Output / Output to Chassis	500 / 500			VDC
GENERAL					
Parameter	Conditions/Description	Min	Nom	Max	Units
<b>Isolation Voltage</b>	Input to Output Input to Chassis	4000 1500			VAC VAC
<b>Efficiency</b>	230VAC, 1340W @ 24V		90		%
<b>Safety Agency Approvals</b>	EN60601-1, UL2601-1, CSA601-1 UL File No. E230761				
<b>Leakage Current</b>	250VAC, 60Hz, 25°C 250VAC, 60Hz, 25°C Option 04			300 150	μA μA
<b>Weight</b>	See weight calculators on Excelsys website				
<b>Signals</b>	See Section 4.9				
<b>Bias Supply</b>	Always on. Current 500mA. (250mA for XVE)	4.8	5.0	5.2	VDC
<b>Reliability</b>	Failures per million hours at 40°C and full load <i>powerMod</i> See Section 7.1 . <i>powerPac</i> excludes fans <i>powerPac</i>			0.958 0.946	fpmh fpmh
EMC					
Parameter	Standard	Level		Units	
<b>Emissions</b>					
<b>Conducted</b>	EN55011, EN55022, FCC		Class B		
<b>Radiated</b>	EN55011, EN55022, FCC		Class B		
<b>Harmonic Distortion</b>	EN61000-3-2 Class A		Compliant		
<b>Flicker &amp; Fluctuation</b>	EN61000-3-3		Compliant		
<b>Immunity</b>					
<b>Electrostatic Discharge</b>	EN61000-4-2		Level 2		
<b>Radiated Immunity</b>	EN61000-4-3		Level 3		
<b>Fast Transients-Burst</b>	EN61000-4-4		Level 3		
<b>Input Line Surges</b>	EN61000-4-5		Level 3		
<b>Conducted Immunity</b>	EN61000-4-6		Level 3		
<b>Voltage Dips</b>	EN61000-4-11, SEMI F47 Compliant (6)		Compliant		
ENVIRONMENTAL					
Parameter	Conditions/Description	Min	Nom	Max	Units
<b>Operating Temperature</b>		-20		+70	°C
<b>Storage Temperature</b>		-40		+85	°C
<b>Derating</b>	See Section 3.2 for full temperature deratings				
<b>Relative Humidity</b>	Non-condensing	5		95	%RH
<b>Acoustic Noise</b>	Measured from distance of 1m; See Page 58 for full table		49.5		
<b>Shock</b>	3000 Bumps, 10G (16ms) half sine				
<b>Vibration</b>	1.5G	10		200	Hz
<b>Altitude</b>	Operational: 2000m, Storage: 8000m				

**NOTES**

1. This product is not intended for use as a stand alone unit and must be installed by qualified personnel.
2. The specifications contained herein are believed to be correct at time of publication and are subject to change without notice.
3. All specifications at nominal input, full load, 25°C unless otherwise stated.
4. XVE: 1450W peak for 10s; Duty cycle 8%. *powerMod* output power must not exceed normal ratings.
5. When powering inductive or capacitive loads, it is recommended to use a blocking diode on the output.
6. SEMI F47 compliant at input voltages >160VAC. Consult Excelsys for details.
7. Visit [www.excelsys.com](http://www.excelsys.com) for configuration and ordering and contact information.
8. Product is not UL/EN certified for 120-380VDC input operation. Consult Excelsys for details.

# 400W-1200W



## Low Acoustic Noise Power Supply

Ultra-high efficiency 1U size



### PLUG & PLAY POWER next generation power solution

#### FEATURES & OPTIONS

- Low Acoustic noise 42.7dBA
- Ultra high efficiency, up to 90%
- Extra low profile: 1U height (40mm)
- Plug & Play Power - allows fast custom configuration
- Individual output control signals
- All outputs fully floating
- Series / Parallel of multiple outputs
- Few electrolytic capacitors (all long life)
- Visual LED indicators
- 5V bias standby voltage provided
- SEMI F47 Compliant
- Active PFC (Power Factor Correction)
- Standard Xgen product options include: Conformal Coating, Low Acoustic Noise, Low Leakage Current, Extra Ruggedisation, Connector, Cabling & Mounting options, Thermal Signals and Reverse Fans. See Section 4.10 for more information

#### APPLICATIONS INCLUDE

- Audio Equipment
- Test and measurement
- Telecommunications

The XQ family of low acoustic noise power supplies provides up to 1200W in an extremely compact 1U x 260mm x 127mm package. Boasting industry leading power density of 15W/in<sup>3</sup> and efficiencies of up to 90%, the XQ family employs an innovative plug & play architecture that allows users to instantly configure a custom power solution in less than 5 minutes!

Ideal for acoustic sensitive applications such as audio applications, the XQ family provides unmatched efficiency and high power density, made possible through the combination of low loss technologies and the best field-proven technologies in planar magnetics and surface mount electronics.

The XQ family consists of 3 *powerPac* models ranging in power levels from 400W to 1200W. each model may be populated with up to 6 *powerMods* selected from the table of *powerMods* shown below.

All configurations carry full safety agency approvals, UL60950, EN60950 and are CE marked.

#### powerPacs

	MODEL	Watts
XQ	XQA	400W
	XQB	900W
	XQC	1200W

#### powerMods

Model	Vnom (V)	Set Point Adjust Range (V)	Dynamic Vtrim Range (V)	I <sub>max</sub> (A)	Power (W)	Remote Sense	Power Good
XgA	12.0	10.8-15.6	-	12.5	150	-	-
XgB	24.0	19.2-26.4	-	8.3	200	-	-
XgC	36.0	28.8-39.6	-	5.6	200	-	-
XgD	48.0	38.5-50.4	-	4.2	200	-	-
XgE/Xg7	24.0	5.0-28.0	-	5.0	120	-	Yes
XgF/Xg8	24.0	5.0-28.0	-	3.0	72	-	Yes
	24.0	5.0-28.0	-	3.0	72	-	Yes
XgG	2.5	1.5-3.6	1.15-3.6	40.0	100	Yes	Yes
XgH	5.0	3.2-6.0	1.5-6.0	36.0	180	Yes	Yes
XgJ	12.0	6.0-15.0	4.0-15.0	18.3	220	Yes	Yes
XgK	24.0	12.0-30.0	8.0-30.0	9.2	220	Yes	Yes
XgL	48.0	28.0-58.0	8.0-58.0	5.0	240	Yes	Yes
Xg1	2.5	1.5-3.6	1.15-3.6	50.0	125	Yes	Yes
Xg2	5.0	3.2-6.0	1.5-6.0	40.0	200	Yes	Yes
Xg3	12.0	6.0-15.0	4.0-15.0	20.0	240	Yes	Yes
Xg4	24.0	12.0-30.0	8.0-30.0	10.0	240	Yes	Yes
Xg5	48.0	28.0-58.0	8.0-58.0	6.0	288	Yes	Yes

See our new Wide Trim *powerMods* on page 40 and Reactive Load *powerMods* on page 42.

**SPECIFICATION** applies to configured units consisting of *powerMods* plugged into the appropriate *powerPac*

INPUT					
Parameter	Conditions/Description	Min	Nom	Max	Units
Input Voltage Range	Universal Input 47-440Hz	85 120		264 380	VAC VDC
Power Rating	XQA:600W, XQB:900W, XQC:1200W See Section 3.2 for line voltage deratings				
Input Current	XQA 85VAC in 400W out XQB 85VAC in 850W out XQC 85VAC in 850W out		7.5 11.5 11.5		A A A
Inrush Current	230VAC @ 25°C			25	A
Undervoltage Lockout	Shutdown	65		74	VAC
Power Factor	110 VAC @ Full Load	0.98	0.99		
Fusing	XQA 250V XQB 250V XQC 250V		F8A HRC F12A HRC F12A HRC		
OUTPUT					
Parameter	Conditions/Description	Min	Nom	Max	Units
<i>powerMod</i> Power	As per <i>powerMod</i> table				
Output Adjustment Range	Manual: Multi-turn potentiometer. As per <i>powerMod</i> table Electronic: See Section 4.6				
Minimum Load			0		A
Line Regulation	For ±10% change from nominal line			±0.1	%
Load & Cross Regulation	For 25% to 75% load change			±0.2	%
Transient Response	For 25% to 75% load change Voltage Deviation Settling Time			10 250	% µs
Ripple and Noise	20MHz 100mV or 1.0% pk-pk				
Overvoltage Protection	1st level: Vset Tracking. 2nd level: Vmax (Latching)	105		170	%
Overcurrent Protection	Straight line with hiccup activation at <30% of Vnom See Section 4.6	105		170	%
Remote Sense	Max. line drop compensation. (except Xg7, Xg8, XgE, XgF, XgR, XgT)			0.5	VDC
Overshoot				2	%
Turn-on Delay	From AC in and Global Enable / <i>powerMod</i> Enable			700 / 6	ms
Rise Time	Monotonic			5	ms
Hold-up Time	For nominal output voltages at full load. XQA, XQB/XQC	20 / 15			ms
Output Isolation	Output to Output / Output to Chassis	500 / 500			VDC
GENERAL					
Parameter	Conditions/Description	Min	Nom	Max	Units
Isolation Voltage	Input to Output Input to Chassis	3000 1500			VAC VAC
Efficiency	230VAC, 1200W @ 24V		90		%
Safety Agency Approvals	EN60950, UL60950, CSA22.2 No.950 UL File No. E181875				
Leakage Current	250VAC, 60Hz, 25°C			1.5	mA
Weight	See weight calculators on Excelsys website				
Signals	See Section 4.9				
Bias Supply	Always on. Current 500mA.	4.8	5.0	5.2	VDC
Reliability	Failures per million hours at 40°C and full load <i>powerMod</i> See Section 7.1 . <i>powerPac</i> excludes fans <i>powerPac</i>			0.958 0.946	fpmh fpmh
EMC					
Parameter	Standard	Level		Units	
<b>Emissions</b>					
Conducted	EN55011, EN55022, FCC		Class B		
Radiated	EN55011, EN55022, FCC		Class B		
Harmonic Distortion	EN61000-3-2 Class A		Compliant		
Flicker & Fluctuation	EN61000-3-3		Compliant		
<b>Immunity</b>					
Electrostatic Discharge	EN61000-4-2		Level 2		
Radiated Immunity	EN61000-4-3		Level 3		
Fast Transients-Burst	EN61000-4-4		Level 3		
Input Line Surges	EN61000-4-5		Level 3		
Conducted Immunity	EN61000-4-6		Level 3		
Voltage Dips	EN61000-4-11, SEMI F47 Compliant <sup>(7)</sup>		Compliant		
ENVIRONMENTAL					
Parameter	Conditions/Description	Min	Nom	Max	Units
Operating Temperature		-20		+70	°C
Storage Temperature		-40		+85	°C
Derating	See Section 3.2 for full temperature deratings				
Relative Humidity	Non-condensing	5		95	%RH
Acoustic Noise	Measured from distance of 1m. See Page 58 for full table		42.7		dBA
Shock	3000 Bumps, 10G (16ms) half sine				
Vibration	1.5G	10		200	Hz
Altitude	Operational: 2000m, Storage: 8000m				

**NOTES**

1. This product is not intended for use as a stand alone unit and must be installed by qualified personnel.
2. The specifications contained herein are believed to be correct at time of publication and are subject to change without notice.
3. All specifications at nominal input, full load, 25°C unless otherwise stated.
4. When powering inductive or capacitive loads, it is recommended to use a blocking diode on the output.
5. Conformal Coating option: See Sections 3.4 and 4.10 for details.
6. For section references above go to the Modular Power Supplies Designers Manual.
7. SEMI F47 compliant at input voltages >160VAC. Consult Excelsys for details.
8. Visit [www.excelsys.com](http://www.excelsys.com) for configuration and ordering and contact information.
9. Product is not UL/EN certified for 120-380VDC input operation. Consult Excelsys for details.



## Medical Power Supply

Low Acoustic Noise 1U size



### PLUG & PLAY POWER next generation power solution

#### FEATURES & OPTIONS

- Low Acoustic noise 42.7dBA
- EN60601-1 3rd edition Approved
- Less than 300µA leakage current
- 150µA option available
- 4000VAC isolation
- Ultra high efficiency, up to 90%
- Extra low profile: 1U height (40mm)
- Plug & Play Power - allows fast custom configuration
- Individual output control signals
- All outputs fully floating
- Series / Parallel of multiple outputs
- Few electrolytic capacitors (all long life)
- 5V bias standby voltage provided
- Active PFC (Power Factor Correction)
- Standard Xgen product options include: Conformal Coating, Low Acoustic Noise, Low Leakage Current, Extra Ruggedisation, Connector, Cabling & Mounting options, Thermal Signals and Reverse Fans. See Section 4.10 for more information

#### APPLICATIONS INCLUDE

- Clinical diagnostic equipment
- Medical lasers
- Dialysis equipment

The XZ family of low acoustic noise medically approved power supplies provides up to 1200W in an extremely compact 1U x 260mm x 127mm package. Boasting industry leading power density of 15W/in<sup>3</sup> and efficiencies of up to 90%, the XZ family employs an innovative plug & play architecture that allows users to instantly configure a custom power solution in less than 5 minutes!

Ideal for acoustic sensitive medical applications the XZ family provides unmatched efficiency and high power density, made possible through the combination of low loss technologies and the best field-proven technologies in planar magnetics and surface mount electronics.

The XZ family consists of 3 *powerPac* models ranging in power levels from 400W to 1200W. Each model may be populated with up to 6 *powerMods* selected from the table of *powerMods* shown below.

All configurations carry full safety agency approvals, UL60601-1, EN60601-1 3rd Edition and are CE marked.

#### powerPacs

	MODEL	Watts
	XZA	400W
	XZB	900W
	XZC	1200W

#### powerMods

Model	Vnom (V)	Set Point Adjust Range (V)	Dynamic Vtrim Range (V)	I <sub>max</sub> (A)	Power (W)	Remote Sense	Power Good
XgA	12.0	10.8-15.6	-	12.5	150	-	-
XgB	24.0	19.2-26.4	-	8.3	200	-	-
XgC	36.0	28.8-39.6	-	5.6	200	-	-
XgD	48.0	38.5-50.4	-	4.2	200	-	-
XgE/Xg7	24.0	5.0-28.0	-	5.0	120	-	Yes
XgF/Xg8	24.0	5.0-28.0	-	3.0	72	-	Yes
	24.0	5.0-28.0	-	3.0	72	-	Yes
XgG	2.5	1.5-3.6	1.15-3.6	40.0	100	Yes	Yes
XgH	5.0	3.2-6.0	1.5-6.0	36.0	180	Yes	Yes
XgJ	12.0	6.0-15.0	4.0-15.0	18.3	220	Yes	Yes
XgK	24.0	12.0-30.0	8.0-30.0	9.2	220	Yes	Yes
XgL	48.0	28.0-58.0	8.0-58.0	5.0	240	Yes	Yes
Xg1	2.5	1.5-3.6	1.15-3.6	50.0	125	Yes	Yes
Xg2	5.0	3.2-6.0	1.5-6.0	40.0	200	Yes	Yes
Xg3	12.0	6.0-15.0	4.0-15.0	20.0	240	Yes	Yes
Xg4	24.0	12.0-30.0	8.0-30.0	10.0	240	Yes	Yes
Xg5	48.0	28.0-58.0	8.0-58.0	6.0	288	Yes	Yes

See our new Wide Trim *powerMods* on page 40 and Reactive Load *powerMods* on page 42.

**SPECIFICATION** applies to configured units consisting of *powerMods* plugged into the appropriate *powerPac*

INPUT					
Parameter	Conditions/Description	Min	Nom	Max	Units
<b>Input Voltage Range</b>	Universal Input 47-440Hz.	85 120		264 380	VAC VDC
<b>Power Rating</b>	XZA:600W, XZB:900W, XZC:1200W See Section 3.2 for line voltage deratings				
<b>Input Current</b>	XZA XZB XZC	85VAC in 400W out 85VAC in 850W out 85VAC in 850W out		7.5 11.5 11.5	A A A
<b>Inrush Current</b>	230VAC @ 25°C			25	A
<b>Undervoltage Lockout</b>	Shutdown	65		74	VAC
<b>Power Factor</b>	110 VAC @ Full Load	0.98	0.99		
<b>Fusing</b>	XZA XZB XZC	250V 250V 250V		F8A HRC F12A HRC F12A HRC	
OUTPUT					
Parameter	Conditions/Description	Min	Nom	Max	Units
<b>powerMod Power</b>	As per <i>powerMod</i> table				
<b>Output Adjustment Range</b>	Manual: Multi-turn potentiometer. As per <i>powerMod</i> table Electronic: See Section 4.6				
<b>Minimum Load</b>			0		A
<b>Line Regulation</b>	For ±10% change from nominal line			±0.1	%
<b>Load &amp; Cross Regulation</b>	For 25% to 75% load change			±0.2	%
<b>Transient Response</b>	For 25% to 75% load change			10	%
	Voltage Deviation Settling Time			250	µs
<b>Ripple and Noise</b>	20MHz 100mV or 1.0% pk-pk				
<b>Overvoltage Protection</b>	1st level: Vset Tracking. 2nd level: Vmax (Latching)	105		170	%
<b>Overcurrent Protection</b>	Straight line with hiccup activation at <30% of Vnom See Section 4.6	105		170	%
<b>Remote Sense</b>	Max. line drop compensation. (except Xg7, Xg8, XgE, XgF, XgR, XgT)			0.5	VDC
<b>Overshoot</b>				2	%
<b>Turn-on Delay</b>	From AC in and Global Enable / powerMod Enable			700 / 6	ms
<b>Rise Time</b>	Monotonic			5	ms
<b>Hold-up Time</b>	For nominal output voltages at full load. XZA, XXB/XZC	20 / 15			ms
<b>Output Isolation</b>	Output to Output / Output to Chassis	500 / 500			VDC
GENERAL					
Parameter	Conditions/Description	Min	Nom	Max	Units
<b>Isolation Voltage</b>	Input to Output Input to Chassis	4000 1500			VAC VAC
<b>Efficiency</b>	230VAC, 1200W @ 24V		90		%
<b>Safety Agency Approvals</b>	EN60601-1, UL60601-1 3rd Edition, CSA601-1 UL File no. E230761				
<b>Leakage Current</b>	250VAC, 60Hz, 25°C 250VAC, 60Hz, 25°C Option 04			300 150	µA µA
<b>Weight</b>	See weight calculators on Excelsys website				
<b>Signals</b>	See Section 4.9				
<b>Bias Supply</b>	Always on. Current 500mA	4.8	5.0	5.2	VDC
<b>Reliability</b>	Failures per million hours at 40°C and full load See Section 7.1. <i>powerPac</i> excludes fans			0.958 0.946	fpmh fpmh
	<i>powerMod</i> <i>powerPac</i>				
EMC					
Parameter	Standard	Level		Units	
<b>Emissions</b>					
<b>Conducted</b>	EN55011, EN55022, FCC		Class B		
<b>Radiated</b>	EN55011, EN55022, FCC		Class B		
<b>Harmonic Distortion</b>	EN61000-3-2 Class A		Compliant		
<b>Flicker &amp; Fluctuation</b>	EN61000-3-3		Compliant		
<b>Immunity</b>					
<b>Electrostatic Discharge</b>	EN61000-4-2		Level 2		
<b>Radiated Immunity</b>	EN61000-4-3		Level 3		
<b>Fast Transients-Burst</b>	EN61000-4-4		Level 3		
<b>Input Line Surges</b>	EN61000-4-5		Level 3		
<b>Conducted Immunity</b>	EN61000-4-6		Level 3		
<b>Voltage Dips</b>	EN61000-4-11, SEMI F47 Compliant <sup>(7)</sup>		Compliant		
ENVIRONMENTAL					
Parameter	Conditions/Description	Min	Nom	Max	Units
<b>Operating Temperature</b>		-20		+70	°C
<b>Storage Temperature</b>		-40		+85	°C
<b>Derating</b>	See Section 3.2 for full temperature deratings				
<b>Relative Humidity</b>	Non-condensing	5		95	%RH
<b>Acoustic Noise</b>	Measured from distance of 1m. See Page 58 for full table		42.7		dBA
<b>Shock</b>	3000 Bumps, 10G (16ms) half sine				
<b>Vibration</b>	1.5G	10		200	Hz
<b>Altitude</b>	Operational: 2000m, Storage: 8000m				

**NOTES**

1. This product is not intended for use as a stand alone unit and must be installed by qualified personnel.
2. The specifications contained herein are believed to be correct at time of publication and are subject to change without notice.
3. All specifications at nominal input, full load, 25°C unless otherwise stated.
4. See Modular Power Supplies Designers Manual for detailed power ratings.
5. When powering inductive or capacitive loads, it is recommended to use a blocking diode on the output.
6. For section references above go to the Modular Power Supplies Designers Manual.
7. SEMI F47 compliant at input voltages >160VAC. Consult Excelsys for details.
8. Visit [www.excelsys.com](http://www.excelsys.com) for configuration and ordering and contact information.
9. Product is not UL/EN certified for 120-380VDC input operation. Consult Excelsys for details.

# 400W-600W



## Hi-Temp Power Supply

Ultra-high efficiency 1U size



### PLUG & PLAY POWER next generation power solution

#### FEATURES & OPTIONS

- Ultra high efficiency, up to 89%
- Extra low profile: 1U height (40mm)
- Plug & Play Power - allows fast custom configuration
- Individual output control signals
- All outputs fully floating
- Series / Parallel of multiple outputs
- Few electrolytic capacitors (all long life)
- Visual LED indicators
- 5V bias standby voltage provided
- SEMI F47 Compliant
- Up to 600W at 70°C
- Active PFC (Power Factor Correction)
- Standard Xgen product options include: Conformal Coating, Low Acoustic Noise, Low Leakage Current, Extra Ruggedisation, Connector, Cabling & Mounting options, Thermal Signals and Reverse Fans. See Section 4.10 for more information

#### APPLICATIONS INCLUDE

- Industrial equipment
- Telecommunications
- Outdoor display systems

The XH family of high temperature power supplies provides up to 600W in an extremely compact 1U x 260mm x 127mm package. Designed as a configurable power supply, the XH family employs the innovative plug and play architecture that allows users to instantly configure a custom power solution in less than 5 minutes.

The XH family is ideal for use in harsh environments where there can be high ambient temperatures and wide temperature fluctuations. Operation at higher temperatures is made possible through employment of leading edge technologies and cooling techniques, making it possible for the XH to achieve unprecedented efficiencies of up to 89%.

The XH family consists of 2 *powerPac* models ranging in power levels from 400W to 600W. Each model may be populated with up to 6 *powerMods* selected from the table of powerMods shown below. All configurations carry full safety agency approvals. UL60950 and EN60950 2nd edition and carry the CE Mark.

#### powerPacs

	MODEL	Watts
XH	XHA	400W
	XHB	600W

#### powerMods

Model	Vnom (V)	Set Point Adjust Range (V)	Dynamic Vtrim Range (V)	I <sub>max</sub> (A)	Power (W)	Remote Sense	Power Good
XgA	12.0	10.8-15.6	-	12.5	150	-	-
XgB	24.0	19.2-26.4	-	8.3	200	-	-
XgC	36.0	28.8-39.6	-	5.6	200	-	-
XgD	48.0	38.5-50.4	-	4.2	200	-	-
XgE/Xg7	24.0	5.0-28.0	-	5.0	120	-	Yes
XgF/Xg8	24.0	5.0-28.0	-	3.0	72	-	Yes
	24.0	5.0-28.0	-	3.0	72	-	Yes
XgG	2.5	1.5-3.6	1.15-3.6	40.0	100	Yes	Yes
XgH	5.0	3.2-6.0	1.5-6.0	36.0	180	Yes	Yes
XgJ	12.0	6.0-15.0	4.0-15.0	18.3	220	Yes	Yes
XgK	24.0	12.0-30.0	8.0-30.0	9.2	220	Yes	Yes
XgL	48.0	28.0-58.0	8.0-58.0	5.0	240	Yes	Yes
Xg1	2.5	1.5-3.6	1.15-3.6	50.0	125	Yes	Yes
Xg2	5.0	3.2-6.0	1.5-6.0	40.0	200	Yes	Yes
Xg3	12.0	6.0-15.0	4.0-15.0	20.0	240	Yes	Yes
Xg4	24.0	12.0-30.0	8.0-30.0	10.0	240	Yes	Yes
Xg5	48.0	28.0-58.0	8.0-58.0	6.0	288	Yes	Yes

See our new Wide Trim *powerMods* on page 40 and Reactive Load *powerMods* on page 42.

**SPECIFICATION** applies to configured units consisting of *powerMods* plugged into the appropriate *powerPac*

INPUT					
Parameter	Conditions/Description	Min	Nom	Max	Units
Input Voltage Range	Universal Input 47-440Hz	85 120		264 380	VAC VDC
Power Rating	XHA:400W, XHB:600W See Section 3.2 for line voltage deratings				
Input Current XHA XHB	85VAC in 400W out 85VAC in 600W out		6.5 7.5		A A
Inrush Current	230VAC @ 25°C			25	A
Undervoltage Lockout	Shutdown	65		74	VAC
Power Factor	110 VAC @ Full Load	0.98	0.99		
Fusing XHA XHB	250V 250V		F10A HRC F12A HRC		
OUTPUT					
Parameter	Conditions/Description	Min	Nom	Max	Units
<i>powerMod</i> Power	As per <i>powerMod</i> table				
Output Adjustment Range	Manual: Multi-turn potentiometer. As per <i>powerMod</i> table Electronic: See Section 4.6				
Minimum Load			0		A
Line Regulation	For ±10% change from nominal line			±0.1	%
Load & Cross Regulation	For 25% to 75% load change			±0.2	%
Transient Response	For 25% to 75% load change Voltage Deviation Settling Time			10 250	% µs
Ripple and Noise	20MHz 100mV or 1.0% pk-pk				
Overvoltage Protection	1st level: Vset Tracking. 2nd level: Vmax (Latching)	105		170	%
Overcurrent Protection	Straight line with hiccup activation at <30% of Vnom See Section 4.6	105		170	%
Remote Sense	Max. line drop compensation. (except Xg7, Xg8, XgE, XgF, XgR, XgT)			0.5	VDC
Overshoot				2	%
Turn-on Delay	From AC in and Global Enable / <i>powerMod</i> Enable			700 / 6	ms
Rise Time	Monotonic			5	ms
Hold-up Time	For nominal output voltages at full load.	20			ms
Output Isolation	Output to Output / Output to Chassis	500 / 500			VDC
GENERAL					
Parameter	Conditions/Description	Min	Nom	Max	Units
Isolation Voltage	Input to Output Input to Chassis	3000 1500			VAC VAC
Efficiency	230VAC, 600W @ 24V		89		%
Safety Agency Approvals	EN60950, UL60950, CSA22.2 No.950 UL File No. E181875				
Leakage Current	250VAC, 60Hz, 25°C		300		mA
Weight	See weight calculators on Excelsys website				
Signals	See Section 4.9				
Bias Supply	Always on. Current 500mA	4.8	5.0	5.2	VDC
Reliability	Failures per million hours at 40°C and full load <i>powerMod</i> See Section 7.12 <i>powerPac</i> excludes fans <i>powerPac</i>			0.958 0.946	fpmh fpmh
EMC					
Parameter	Standard	Level			Units
<b>Emissions</b>					
Conducted	EN55011, EN55022, FCC		Class B		
Radiated	EN55011, EN55022, FCC		Class B		
Harmonic Distortion	EN61000-3-2 Class A		Compliant		
Flicker & Fluctuation	EN61000-3-3		Compliant		
<b>Immunity</b>					
Electrostatic Discharge	EN61000-4-2		Level 2		
Radiated Immunity	EN61000-4-3		Level 3		
Fast Transients-Burst	EN61000-4-4		Level 3		
Input Line Surges	EN61000-4-5		Level 3		
Conducted Immunity	EN61000-4-6		Level 3		
Voltage Dips	EN61000-4-11, SEMI F47 Compliant <sup>(7)</sup>		Compliant		
ENVIRONMENTAL					
Parameter	Conditions/Description	Min	Nom	Max	Units
Operating Temperature	Full Load	-20		+70	°C
Storage Temperature		-40		+85	°C
Derating	See Section 3.2 for full temperature deratings				
Relative Humidity	Non-condensing	5		95	%RH
Acoustic Noise	Measured from distance of 1m; See Page 58 for full table		49.5		
Shock	3000 Bumps, 10G (16ms) half sine				
Vibration	1.5G	10		200	Hz
Altitude	Operational: 2000m, Storage: 8000m				

### NOTES

1. This product is not intended for use as a stand alone unit and must be installed by qualified personnel.
2. The specifications contained herein are believed to be correct at time of publication and are subject to change without notice.
3. All specifications at nominal input, full load, 25°C unless otherwise stated.
4. When powering inductive or capacitive loads, it is recommended to use a blocking diode on the output.
5. Conformal Coating option: See Sections 3.4 and 4.10 for details.
6. For section references above go to the Modular Power Supplies Designers Manual.
7. SEMI F47 compliant at input voltages >160VAC. Consult Excelsys for details.
8. Visit [www.excelsys.com](http://www.excelsys.com) for configuration and ordering and contact information.
9. Product is not UL/EN certified for 120-380VDC input operation. Consult Excelsys for details.

# Wide Trim powerMod Series

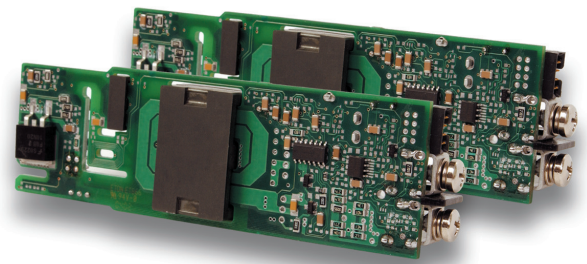

## PLUG & PLAY POWER next generation power solution

### FEATURES & OPTIONS

- Dual Safety Approvals
  - UL/EN60950 2<sup>nd</sup> edition
  - UL/EN60601-1 3<sup>rd</sup> edition
- 1.0V to 58V standard output voltages
- Standard Medical Features
  - Leakage Current <300 $\mu$ A (<150 $\mu$ A optional)
  - 2 MOPP
  - 4KV Isolation
- Highest Efficiency - up to 92%
- SEMI F47 Compliant
- Individual output control signals
- - 40°C Startup Temperature
- Conducted EMI EN 55022 Class B
- OVP, OTP, OCP as standard
- MIL STD-810G: Shock & Vibration
- Adjustable output voltages
- Adjustable current limit
- Output inhibit / enable control
- Parallel / Series of multiple outputs
- All outputs fully floating
- These new *powerMods* are all 100% interchangeable and compatible with all Excelsys Modular *powerPacs* & other *powerMods*

### TYPICAL APPLICATIONS

- Medical; Clinical diagnostic equipment, Dialysis equipment, Clinical & Cosmetic Lasers, Radiological Imaging, Clinical Chemistry
- Industrial; Test and Measurement, Industrial Machines, Lasers, Automation equipment, Printing, Telecommunications, Audio equipment,
- Hi Rel / MILCOTS; Harsh Industrial Electronics, Radar

The new Wide-Trim *powerMod* family of plug-in DC modules from Excelsys is compatible with all *powerPac* families in the Excelsys range. The *powerMods* convert the intermediate bus voltage provided by the *powerPac* to your specific output DC voltage requirements. The *powerPac* families include UltiMod, Ultra Quiet Xgen, High Power Xgen and Hi-Rel/MILCOTS Xgen available as stand-alone chassis to 1340W, but each can be paralleled for operation above 2KW.

The existing Excelsys *powerMods* provide output voltages from 1.5V to 58V. The feature rich *powerMods* provide a suite of output signals and user configurable functions increasing design-in flexibility. User configurable functions include local and remote adjustment, adjustable current limit, dynamic voltage trim/adjust, alternative current limiting technique and inhibit/enable functions. Existing *powerMods* in this range include XgA-XgL and Xg1-Xg8.

Excelsys now expands this family with four new *powerMods* with each offering extra-wide voltage trim ranges, along with the complete suite of standard control features. The new *powerMods*; XgM, XgN, XgP and XgQ are available with nominal voltages of 5V, 12V, 24V, and 48V respectively, each can be trimmed down to 1.0V. All *powerMods* can be simply plugged into a standard *powerPac* in the normal way, all modules are interchangeable and can be put in series or parallel ensuring that you have the most flexible power supply at your fingertips.

The XgM, XgN, XgP and XgQ *powerMods* continue the Excelsys tradition of providing an instant, no compromise power solution for any application where a unique set of voltage and current requirements is needed.

**5 YEAR**  
Warranty

### *powerMods*

MODEL	Vnom	Set Point Adjust Range (V)	Dynamic Vtrim Range (V)	I <sub>max</sub> (A)	Power (W)	I Limit onset	OVP	Remote Sense	Power Good
XgM	5.0	3.2-6.0	1.0 to 6.0	40	200	49.5	7.3	Yes	Yes
XgN	12.0	6.0-15.0	1.0 to 15.0	20	240	27.5	18.0	Yes	Yes
XgP	24.0	12.0-30.0	1.0 to 30.0 <sup>(1)</sup>	10	240	14.5	34.0	Yes	Yes
XgQ	48.0	24.0-58.0	1.0 to 58.0 <sup>(2)</sup>	6	288	7.4	64.0	Yes	Yes



## Output Connectors

The output *powerMods* connection details are shown below. The power and signal connectors are as follows:

### Type A: *powerMods*

#### XgM, XgN, XgP, XgQ

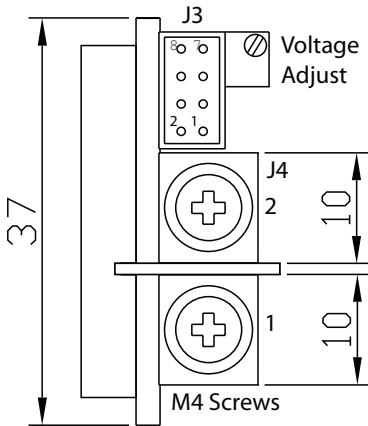

### Output Signals and Power Connector Pinout

Pin	J3	J4
1	+Sense	-Vout
2	-Sense	+Vout
3	Vtrim	
4	Itrim	
5	+Inhibit/Enable	
6	-Inhibit/Enable	
7	+pg	
8	-pg	

## Output Mating Connectors

J3: Locking Molex 51110-0860; Non Locking Molex 51110-0850; Crimp Terminal: Molex p/n 50394. Or Molex 51110-0856, includes Locking Tab & Polarization Keying,

J4 (Type A): M4 Screw (8mm)

## Series Connection

To achieve increased output voltages, simply series outputs using standard series links, paying attention to the requirements to maintain SELV levels if required in your system.

## Parallel Connection for *powerMods*

To achieve increased current capacity, simply parallel outputs using the standard parallel links. Excelsys 'wireless' sharing ensures that current hogging is not possible. To parallel connect outputs:

1. Switch on IShare switch to ON for *powerMods* XgM - XgQ
2. Connect Negative Parallel Link.
3. Adjust output voltages of *powerMods* to within 5mV of each other.
4. Connect Positive Parallel Link.

## DIP Switch for Current Share & Inhibit/Enable for *powerMods*



Dip Switch settings above are:

Current Share: OFF  
Inhibit ON: Normally ON

## PowerPacs

These *powerMods* can be used in conjunction with any Excelsys Modular *powerPac* for a variety of applications in Medical, Industrial, Communications or Military markets.

## NOTES

1. From 1V to 4.5V XgP output ripple and transient response are load dependent. Please consult Excelsys Applications Engineering Team or support@excelsys.com for performance characterisation.
2. From 1V to 7V XgQ output ripple and transient response are load dependent. Please consult Excelsys Applications Engineering Team or support@excelsys.com for performance characterisation.
3. Refer to the UltiMod Designers Manual for additional information.
4. Visit www.excelsys.com for configuration and ordering and contact information.

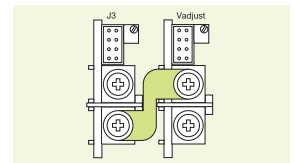

Series Links available.  
Part Number XS1

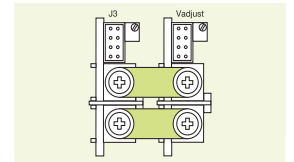

Parallel Links available to order. Part Number XP1

## DIP Switch Option

*powerMods* can be configured to be normally ON or normally OFF by appropriate setting of the DIP switch on the *powerMod*. (default mode is normally ON). The *powerMod* will deliver output voltage when mains is applied (and the *powerPac* is enabled). The *powerMod* requires an external 5V signal (between +IN/EN and -IN/EN) to disable the output pins. This may be reversed by setting of the dip switch to the OFF position.

# Reactive Load PowerMod Series

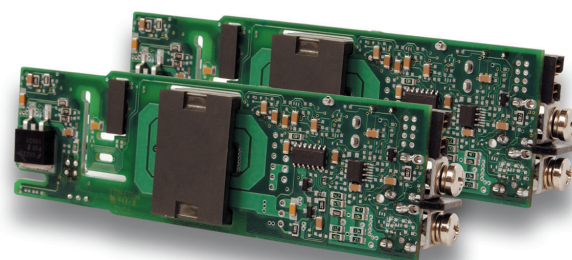

**PLUG & PLAY POWER**  
next generation power solution

## FEATURES & OPTIONS

- Dual Safety Approvals
  - UL/EN60950 2<sup>nd</sup> edition
  - UL/EN60601-1 3<sup>rd</sup> edition
- 8.0V to 58V standard output voltages
- Standard Medical Features
  - Leakage Current <300µA (<150µA optional)
  - 2 MOPP
  - 4KV Isolation
- Highest Efficiency - up to 92%
- SEMI F47 Compliant
- Individual output control signals
- - 40°C Startup Temperature
- Conducted EMI EN 55022 Class B
- OVP, OTP, OCP as standard
- MIL STD-810G: Shock & Vibration
- Adjustable current limit
- Output inhibit / enable control
- Parallel / Series of multiple outputs
- All outputs fully floating
- Or-ing FET protection on output
- Reverse Voltage Protection on output

## TYPICAL APPLICATIONS

- Medical; Clinical diagnostic equipment, Medical lasers, Dialysis equipment, Radiological Imaging, Clinical Chemistry
- Industrial; Test and Measurement, Industrial Machines, Automation equipment, Printing, Telecommunications, Audio equipment,
- Hi Rel / MILCOTS; Harsh Industrial Electronics, Radar

Excelsys Technologies new Reactive Load *powerMod* series of plug-in DC modules is optimised for driving reactive loads, such as DC motors. These *powerMods* offer complete protection where loads can generate high levels of reverse energy thereby increasing system robustness and reliability.

These *powerMods* are compatible with all Excelsys UltiMod, XF, and Xgen *powerPacs* and can deliver output voltages from 8.0V to 58V. The feature rich *powerMods* provide a suite of output signals and user configurable functions increasing design-in flexibility. User configurable functions include local and remote adjustment, adjustable current limit, dynamic voltage trim/adjust, alternative current limiting technique and inhibit/enable functions. Modules can be connected in series or parallel ensuring that any voltage/current requirements can be achieved.

The new XgR and XgT additions to the *powerMod* series come equipped with in-built ORing function and an anti-reversal diode. The ORing circuit (utilising a MOSFET to maintain high efficiency) offers N+1 redundancy to the user when the *powerMods* are used in parallel operation and increases the ruggedness of the system in reactive load applications. The anti-reversal diode across the output, which is rated for the full current of the module, offers increased ruggedness when the modules are used in reactive load applications.

Used in conjunction with the broad range of existing *powerMods* (XgA-XgL and Xg1-Xg8), the XgR and XgT *powerMods* continue the Excelsys tradition of providing an instant, no compromise power solution for any application where a unique set of voltage and current requirements is needed.



### *powerMods*

MODEL	Vnom	Set Point Adjust Range (V)	Dynamic Vtrim Range (V)	I <sub>max</sub> (A)	Power (W)	I Limit onset	OVP	Power Good
XgR	24.0	12.0-30.0	8.0 to 30.0	10	240	14.5	34.0	Yes
XgT	48.0	28.0-58.0	8.0 to 58.0	6	288	7.4	64.0	Yes

## Output Connectors

The output *powerMods* connection details are shown below. The power and signal connectors are as follows:

### Type A: *powerMods*

#### XgR & XgT

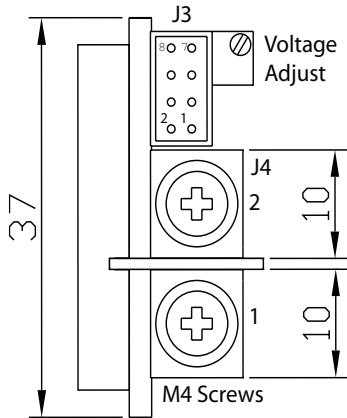

### Output Signals and Power Connector Pinout

Pin	J3	J4
1		-Vout
2		+Vout
3	Vtrim	
4	Itrim	
5	+Inhibit/Enable	
6	-Inhibit/Enable	
7	+pg	
8	-pg	

## Output Mating Connectors

J3: Locking Molex 51110-0860; Non Locking Molex 51110-0850; Crimp Terminal: Molex p/n 50394.

J4: M4 Screw (8mm)

## Series Connection

To achieve increased output voltages, simply series outputs using standard series links, paying attention to the requirements to maintain SELV levels if required in your system.

## Parallel Connection for *powerMods*

To achieve increased current capacity, simply parallel outputs using the standard parallel links. Excelsys 'wireless' sharing ensures that current hogging is not possible. To parallel connect outputs:

1. Switch on IShare switch to ON for *powerMods* XgR & XgT
2. Connect Negative Parallel Link.
3. Adjust output voltages of *powerMods* to within 5mV of each other. (To ensure accurate current share between modules, it is necessary to load the modules with at least 100 mA during this step. A simple resistor can be used for this load)
4. Connect Positive Parallel Link.

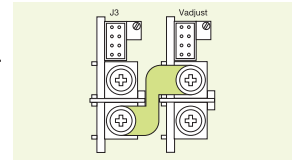

Series Links available.  
Part Number XS1

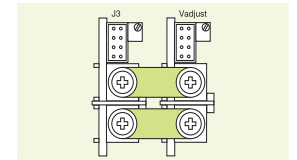

Parallel Links available to order. Part Number XP1

## DIP Switch for Current Share & Inhibit/Enable for *powerMods*



Dip Switch settings above are:  
Current Share: OFF  
Inhibit ON: Normally ON

### DIP Switch Option

*powerMods* can be configured to be normally ON or normally OFF by appropriate setting of the DIP switch on the *powerMod*. (default mode is normally ON). The *powerMod* will deliver output voltage when mains is applied (and the *powerPac* is enabled). The *powerMod* requires an external 5V signal (between +IN/EN and -IN/EN) to disable the output pins. This may be reversed by setting of the dip switch to the OFF position.

## PowerPacs

These *powerMods* are used in conjunction with Excelsys Modular *powerPacs*. This *powerPac* family provides power from 200W to 1340W and is used throughout various industries including Medical, Industrial, Communications and Military. Consult Excelsys for details.

# Section 3 Connectors, Derating, Mechanical Drawings and Configuration

## Section 3.1

### Connectors for Xgen Series

#### Output Connectors

The output *powerMods* connection details are shown below. Type A connectors are for single output *powerMods* XgA-XgT and Xg1-Xg7. The Type B connector is for the dual output XgF/Xg8 *powerMod*. The power and signal connectors are as follows:

**Type A: *powerMods***  
XgA to XgE  
XgG to XgT  
Xg1 to Xg7

**Type B: *powerMod***  
XgF/Xg8

#### Output Signals and Power Connector Pinout

Pin	J3 Module (XgA to XgD)	J3 (XgG-XgT) (Xg1-Xg5)	J3 (XgE) (Xg7)	J3 (XgF) (Xg8)	J4 (Type A)	J4 (Type B)
1	not used	+Sense*	not used	-pg (V2)	-Vout	-V2
2	Common	-Sense*	not used	+pg (V2)	+Vout	+V2
3	not used	Vtrim	not used	Inhibit (V2)		-V1
4	not used	Itrim	Common	Common (V2)		+V1
5	+Inhibit	+Inhibit/Enable	-pg	-pg (V1)		
6	-Inhibit	-Inhibit/Enable	+pg	+pg (V1)		
7	not used	+pg	Inhibit	Inhibit (V1)		
8	not used	-pg	Common	Common (V1)		

\*remote sense not present on XgR and XgT *powerMods*.

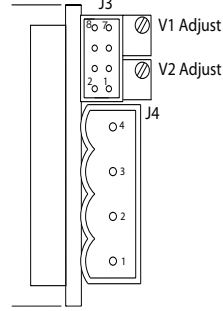
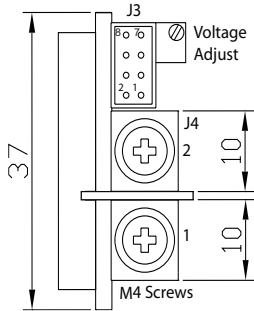

#### Output Mating Connectors

J3: Locking Molex 51110-0860; Non Locking Molex 51110-0850; Crimp Terminal: Molex p/n 50394: Or Molex 51110-0856, includes Locking Tab & Polarization Keying

J4 (Type A): M4 Screw (8mm)

J4 (Type B) Connector(s): Camden CTB9200/4A

#### Input Connectors

Excelsys modular power supplies have a variety of input connector options to ease system integration. These include IEC, Input cables (3-wire) and IEC to Screw Terminal Adaptor.

#### J1 & J2 Connectors (4-slot)

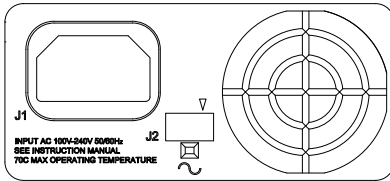

#### J1 & J2 Connectors (6-slot)

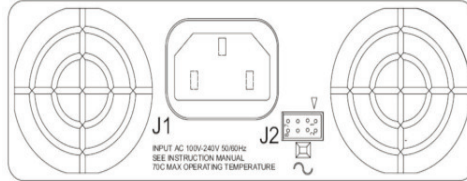

Pin	J1	J2
1	Line	Common
2	Neutral	+5V Bias
3	Earth	not used
4		AC Fail
5		Fan Fail
6		Global Enable
7		Temp Alarm
8		Global Inhibit

#### Input Mating Connectors

J1: IEC320 type female plug rated 13, Locking IEC cable and connector: Schaffner EMC part number IL13-US1-SVT-3100-183.

J2: Locking Molex 51110-0860; Non Locking 51110-0850; Crimp Terminal: Molex p/n 50394: Or Molex 51110-0856, includes Locking Tab & Polarization Keying

#### Input Cable (Option D)

Excelsys modular power supplies are also available with an input cable connection option allowing greater flexibility when mounting the power supply in the system. Individually insulated input cables are 300mm in length and come supplied with Faston connectors.

#### IEC to Screw Terminal Adaptor

Some applications may require a screw terminal input rather than the standard IEC320 connector provided with Excelsys modular power supplies. For such applications, Excelsys can offer the XE1, the IEC to Screw terminal adaptor accessory plug. This is a press fit connector that plugs securely into the *powerPac* and provides the system integrator with screw terminals for mains connection (not available on XCE, XVE, XMD, XLD, XF). Recommended IEC to Faston/Terminal Lugs Schurter P/N 4788.8000

#### Modular Power Supply Mounting Options

##### 1. Base Plate Mounting

The unit can be mounted in the system via the mounting holes present on the UltiMod and Xgen base. See mechanical drawings for mounting hole positions. Use M4 mounting screws. Ensure that maximum screw penetration from base does not exceed 6mm.

##### 2. Fleximount System A

Using the side mounting clips accessory shown, the clip can be positioned at the user defined position along the slide rail on the side of the UltiMod/Xgen. The clip is then mounted to the system base plate. Use M4 mounting screws to fix mounting clip to system base. Excelsys part number Z165.

##### 3. Fleximount System B

Using the slide rail on side of the UltiMod/Xgen, self clenching studs can be placed at a user defined position. Recommend: PEM FH-M4-X or FH-832-X or equivalent.

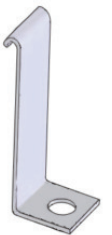

## Section 3.2 Deratings Curves for Xgen Series

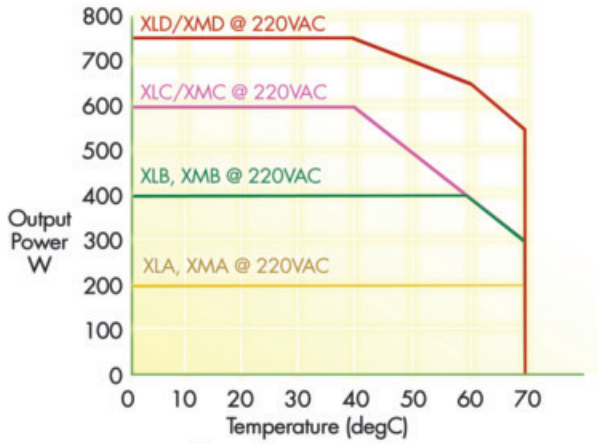

**XLA/XLB/XLC/XLD and XMA/XMB/XMC/XMD @ 220VAC Derating**

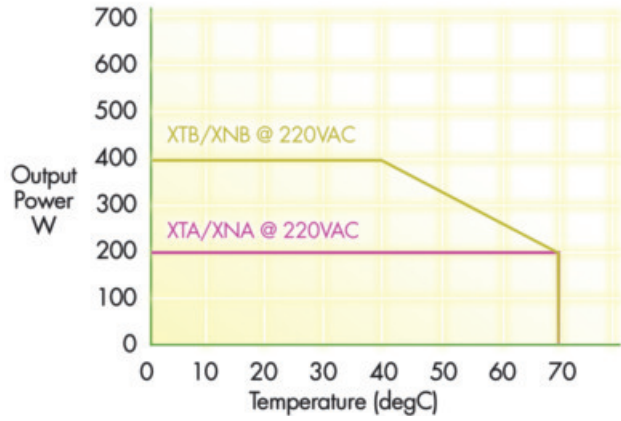

**XTA/XTB and XNA/XNB @ 220VAC Derating**

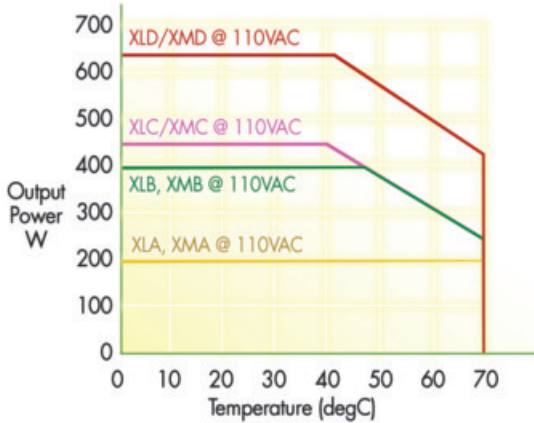

**XLA/XLB/XLC/XLD and XMA/XMB/XMC/XMD @ 110VAC Derating**

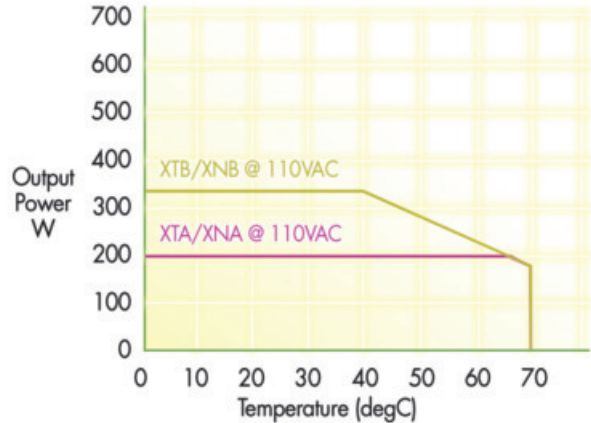

**XTA/XTB and XNA/XNB @ 110VAC Derating**

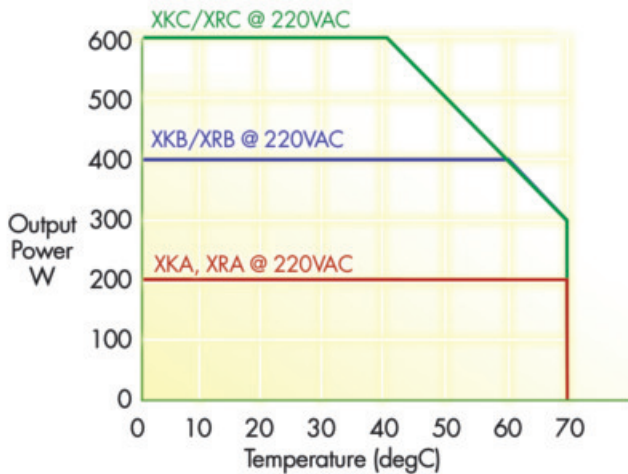

**XKA/XKB/XKC and XRA/XRB/XRC @ 220VAC Derating**

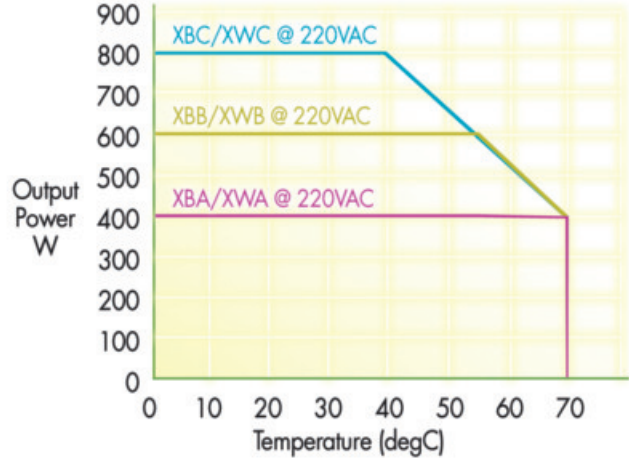

**XBA/XBB/XBC and XWA/XWB/XWC @ 220VAC Derating**

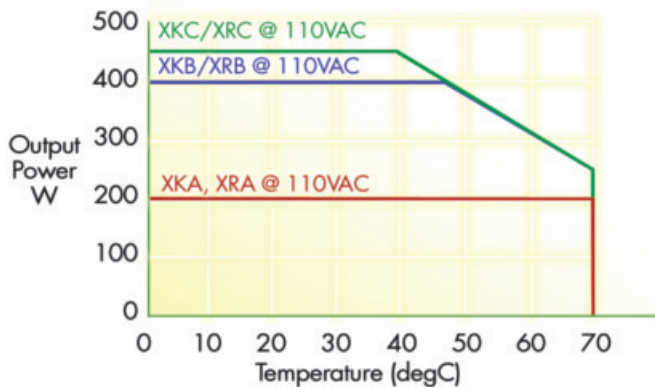

**XKA/XKB/XKC and XRA/XRB/XRC @ 110VAC Derating**

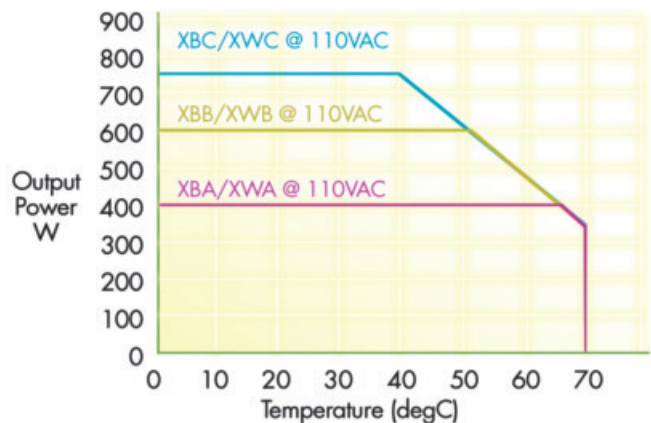

**XBA/XBB/XBC and XWA/XWB/XWC @ 110VAC Derating**

## Deratings Curves for Xgen Series

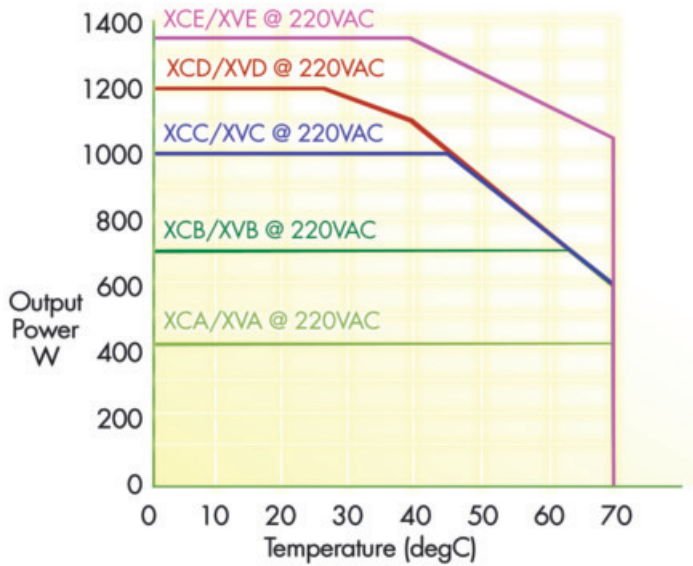

XCA/XCB/XCC/XCD/XCE and XVA/XVB/XVC/XVD/XVE Derating @ 220VAC Derating

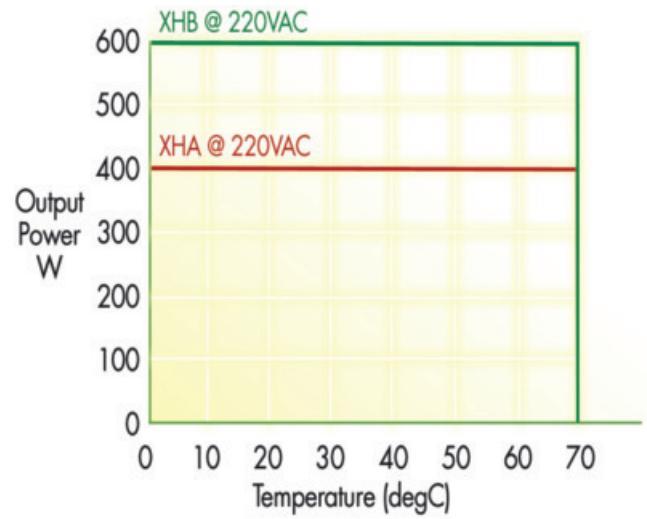

XHA/XHB @ 220VAC Derating

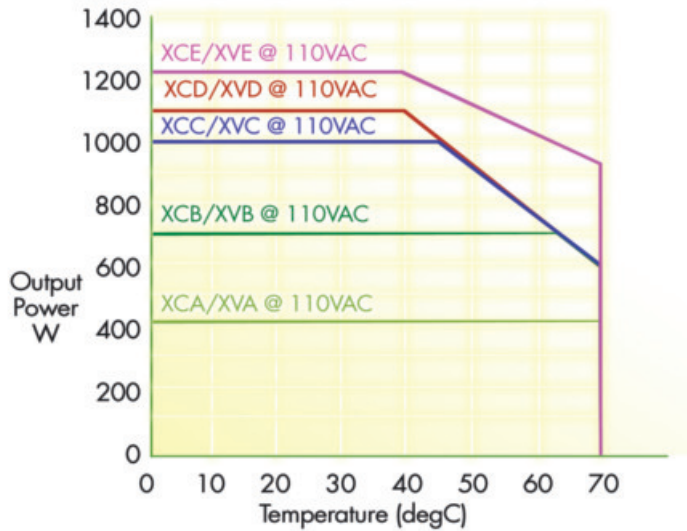

XCA/XCB/XCC/XCD/XCE and XVA/XVB/XVC/XVD/XVE Derating @ 110VAC Derating

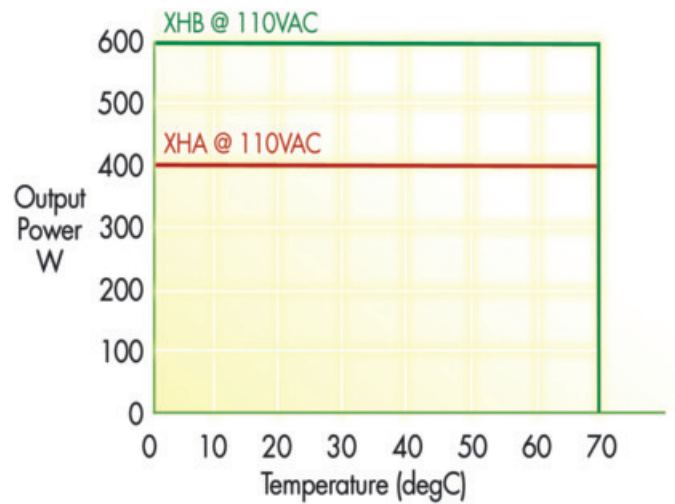

XHA/XHB @ 110VAC Derating

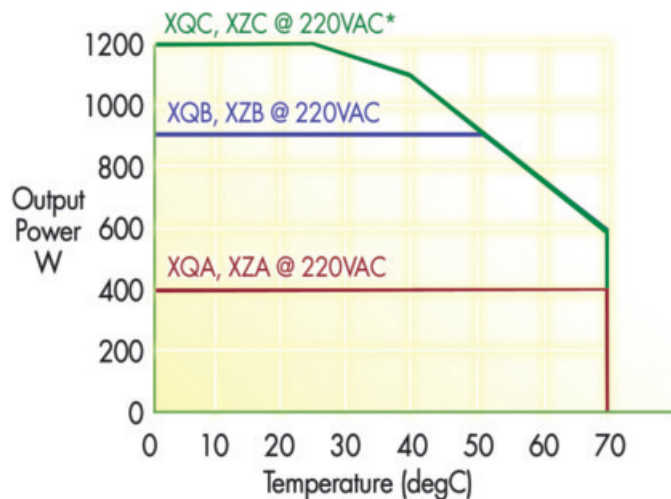

XQA/XQB/XQC and XZA/XZB/XZC @ 220VAC Derating

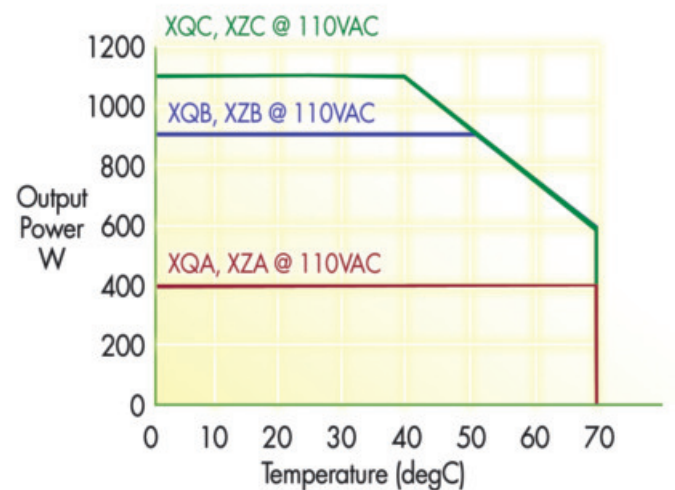

XQA/XQB/XQC and XZA/XZB/XZC @ 110VAC Derating

## Section 3.3

### Modular Power Supplies Mechanical Drawings

All 3D/CAD Drawings available at <http://www.excelsys.com/technical-support/3d-files-and-cad-drawings/>

#### UX4 and XM, XK, XR, XT, XN, XL (except XLD and XMD)

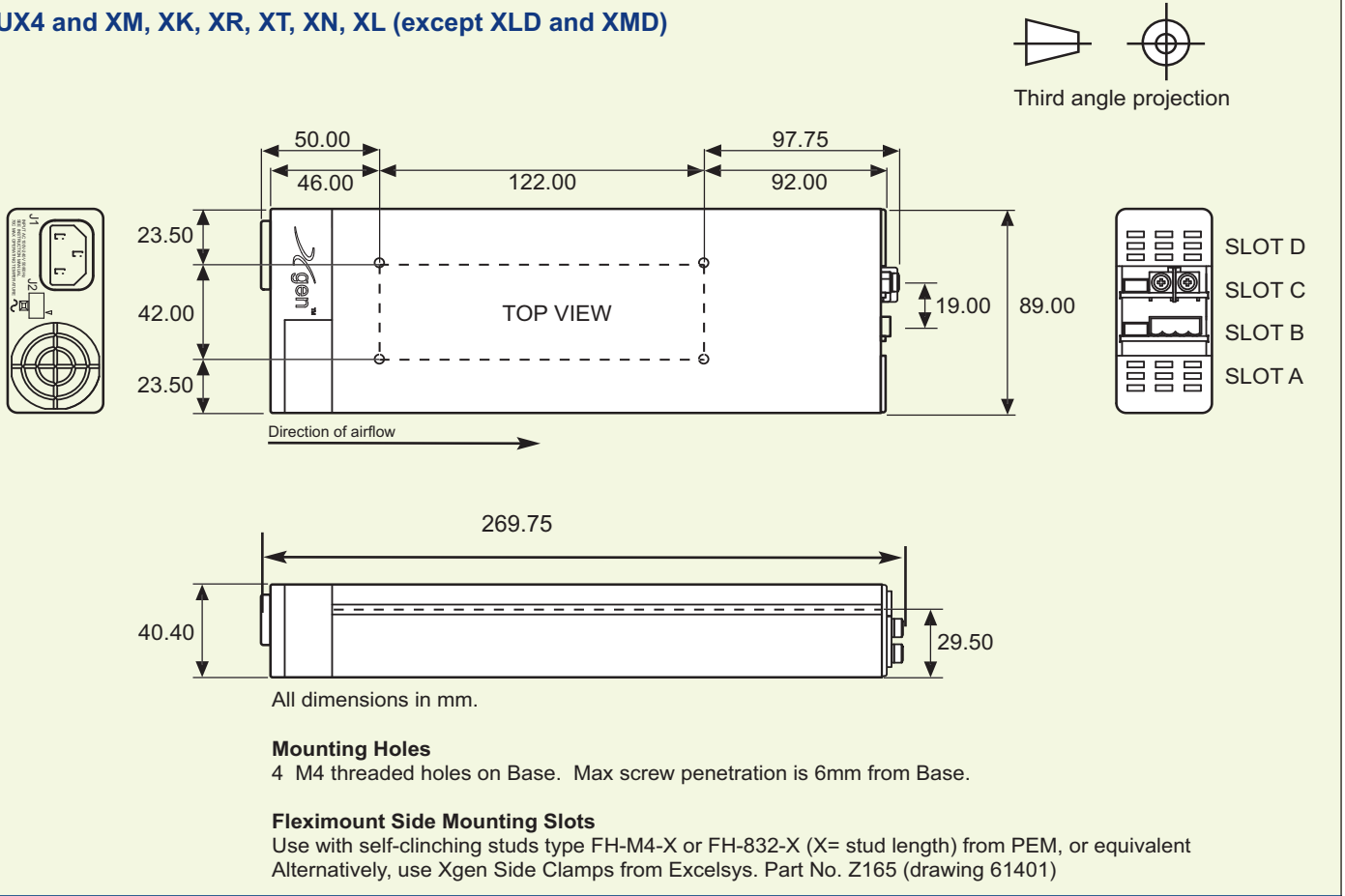

TOLERANCES unless otherwise stated, according to DIN 2768-1/-2 CLASS M ALL DIMENSIONS in mm. See <http://www.excelsys.com/technical-support/> for DIN table.

#### XLD, XMD

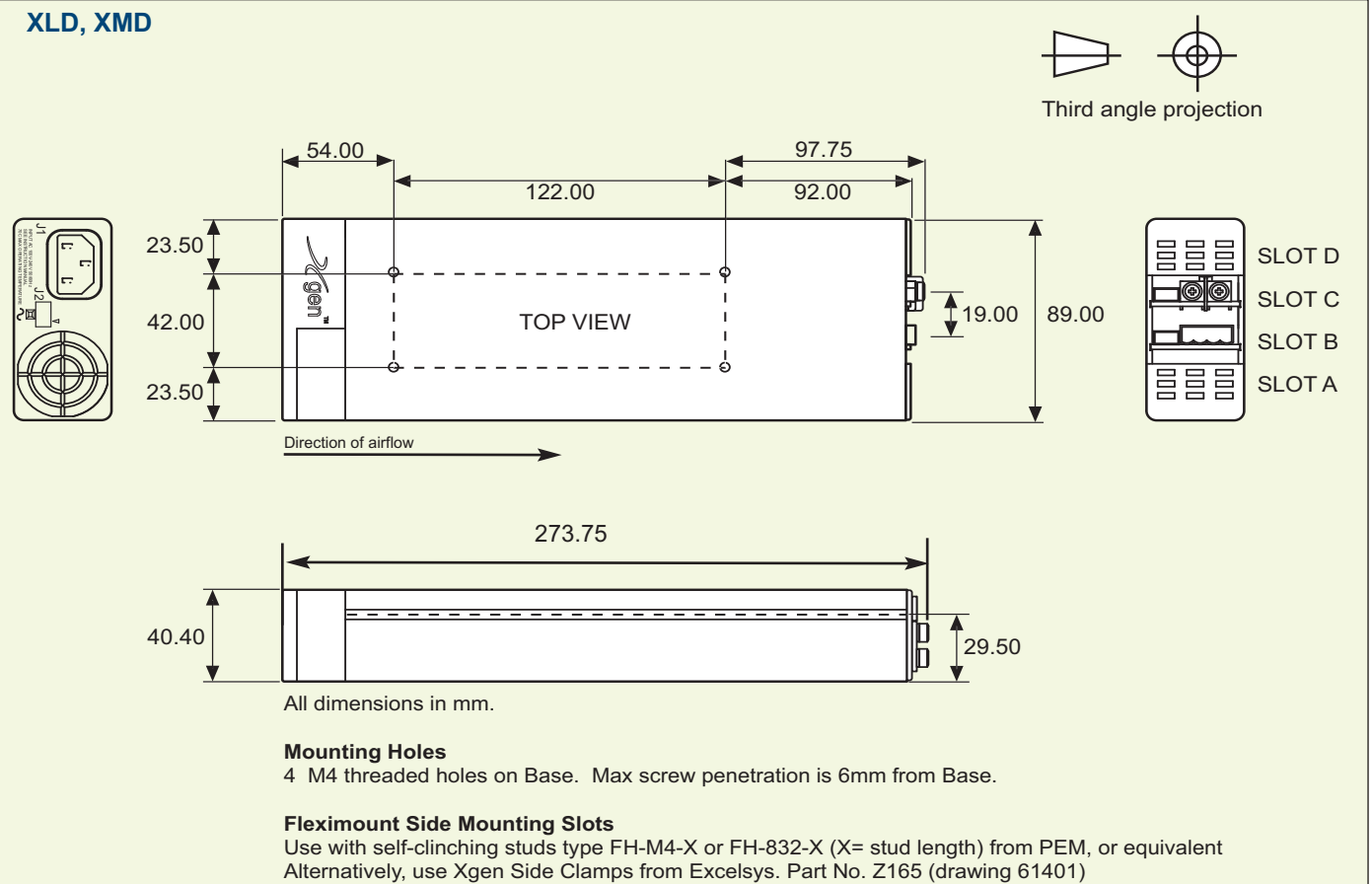

TOLERANCES unless otherwise stated, according to DIN 2768-1/-2 CLASS M ALL DIMENSIONS in mm. See <http://www.excelsys.com/technical-support/> for DIN table.

**UX6 and XC, XV, XQ, XZ, XB, XW, XH (except XCE and XVE)**

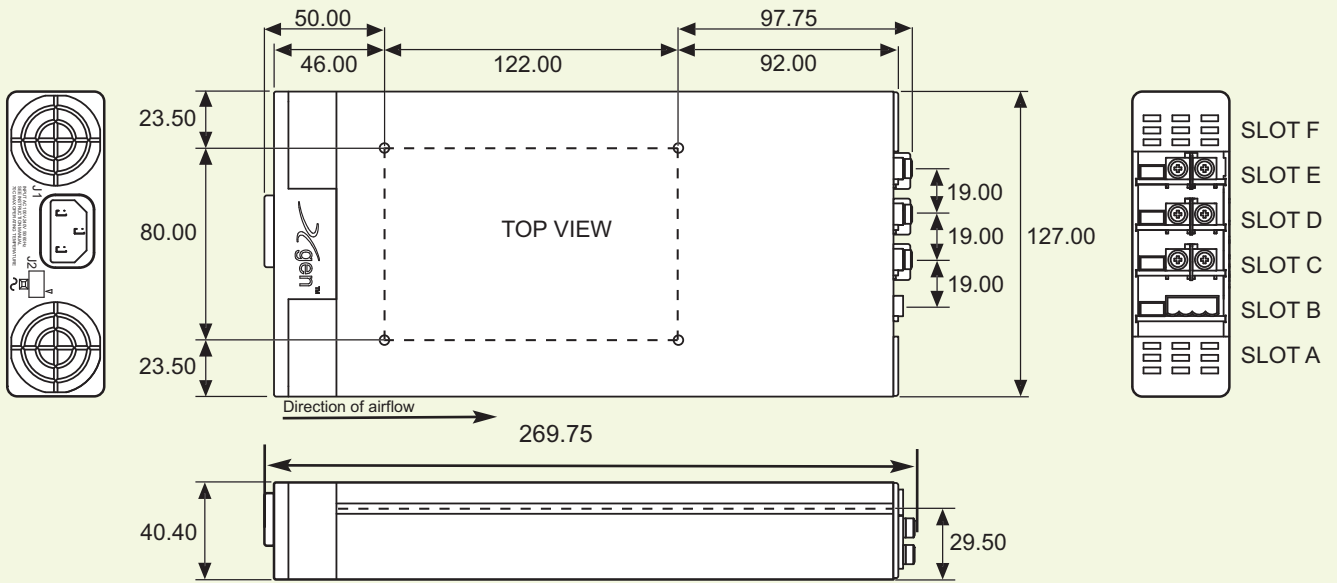
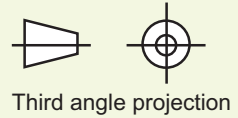

All dimensions in mm.

**Mounting Holes**

4 M4 threaded holes on Base. Max screw penetration is 6mm from Base.

**Fleximount Side Mounting Slots**

Use with self-clinching studs type FH-M4-X or FH-832-X (X= stud length) from PEM, or equivalent  
Alternatively, use Xgen Side Clamps from Excelsys. Part No. Z165 (drawing 61401)

TOLERANCES unless otherwise stated, according to DIN 2768-1/-2 CLASS M ALL DIMENSIONS in mm. See <http://www.excelsys.com/technical-support/> for DIN table.

**XCE, XVE & XF**

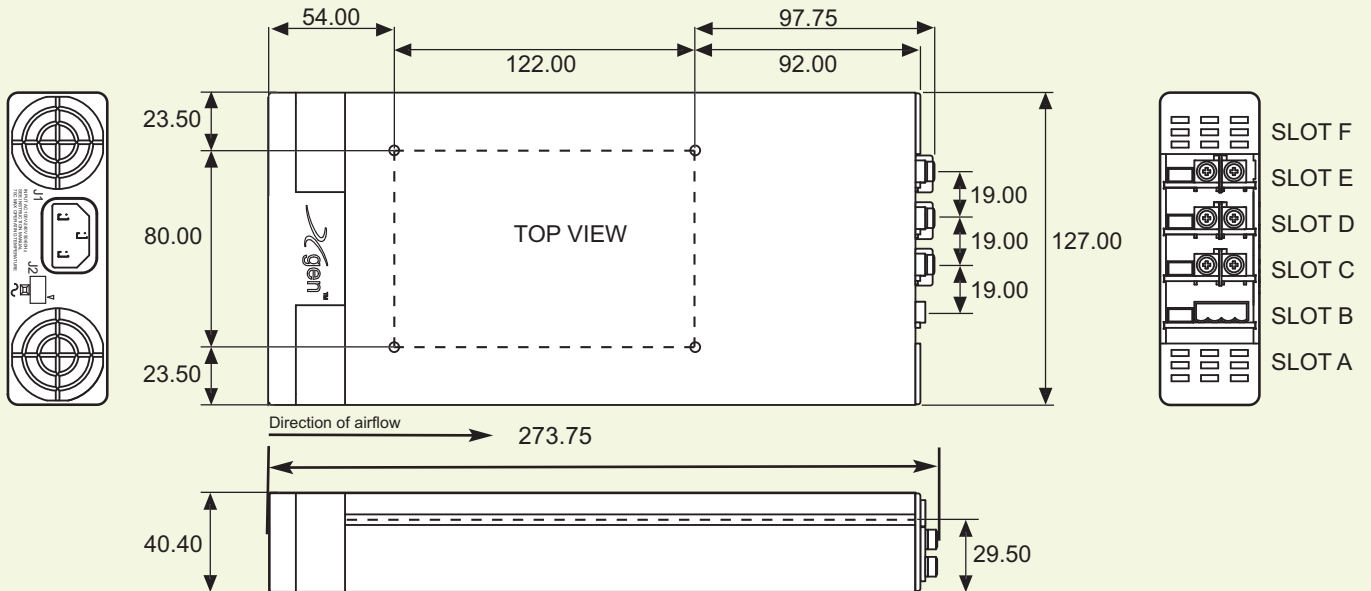
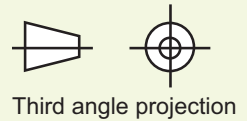

All dimensions in mm.

**Mounting Holes**

4 M4 threaded holes on Base. Max screw penetration is 6mm from Base.

**Fleximount Side Mounting Slots**

Use with self-clinching studs type FH-M4-X or FH-832-X (X= stud length) from PEM, or equivalent  
Alternatively, use Xgen Side Clamps from Excelsys. Part No. Z165 (drawing 61401)

TOLERANCES unless otherwise stated, according to DIN 2768-1/-2 CLASS M ALL DIMENSIONS in mm. See <http://www.excelsys.com/technical-support/> for DIN table.



**XCE, XVE**

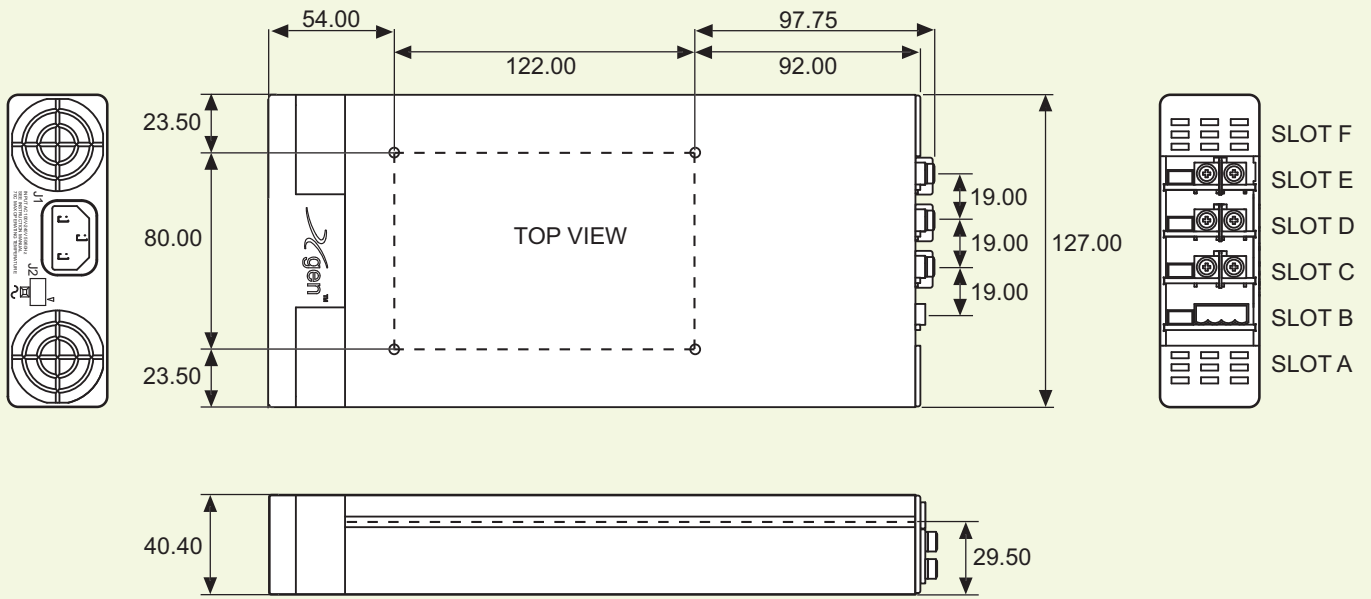
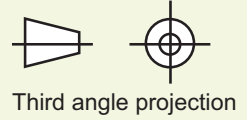

All dimensions in mm.

**Mounting Holes**

4 M4 threaded holes on Base. Max screw penetration is 6mm from Base.

**Fleximount Side Mounting Slots**

Use with self-clinching studs type FH-M4-X or FH-832-X (X= stud length) from PEM, or equivalent  
Alternatively, use Xgen Side Clamps from Excelsys. Part No. Z165 (drawing 61401)

**4 slot Input Cable Version (Option D)**

Standard cable length 300mm, please contact factory for alternative lengths

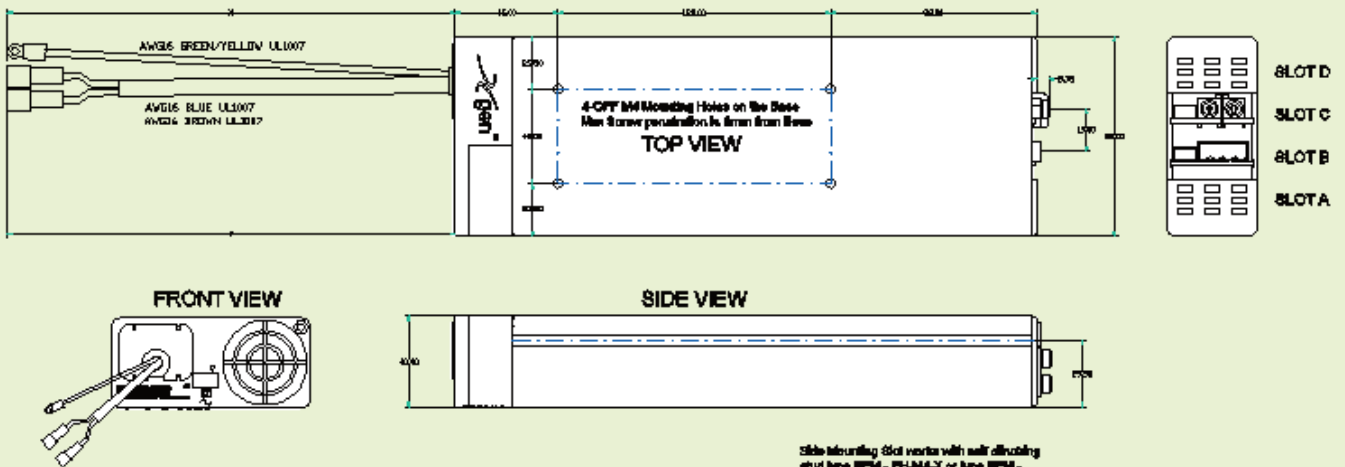

Side mounting slot works with self-clinching stud type PEM - FH-M4-X or type PEM - FH-832-X or similar. X represents the length of the stud.  
Alternatively, the Side Mounting Slots may be used with Excelsys Side Clamps (Drawing no. 61401)

# 6 slot Input Cable Version (Option D)

Standard cable length 300mm, please contact factory for alternative lengths

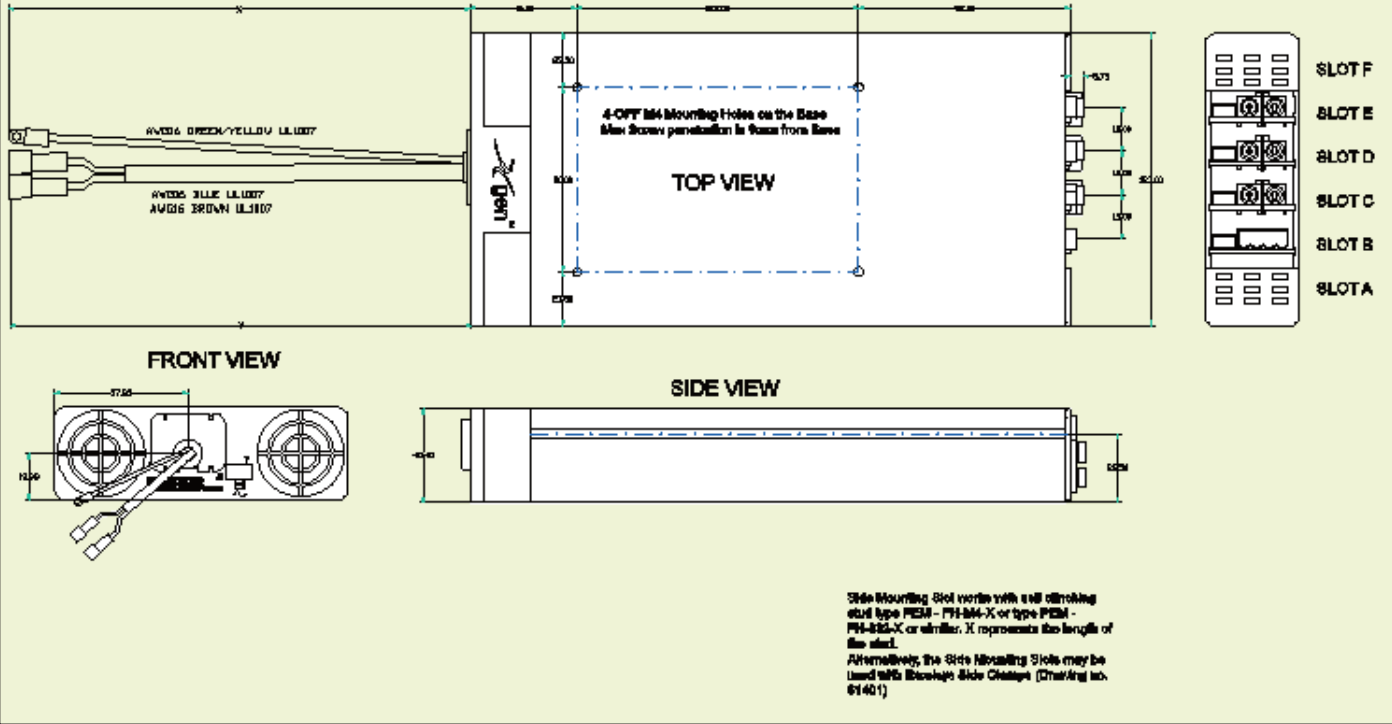

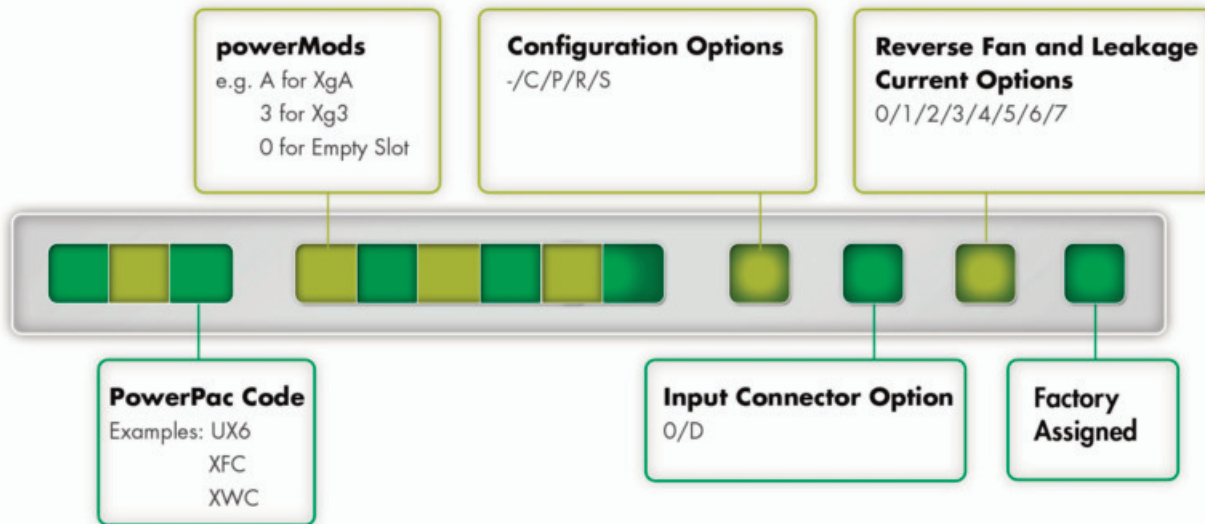

## Section 3.4 Configuring your Modular Power Supply

The Xgen and UltiMod series of user configurable power supplies combine feature rich AC input front-ends (*powerPacs*) with slide-in DC output modules (*powerMods*). The plug and play architecture allows system designers to define and build 'instant' custom power solutions with industry leading 17W/in<sup>3</sup> power density and up to 92% efficiency.

**Configured units** may be specified and ordered using the part numbering system shown above.

### OPTION CODES EXPLAINED

#### CONFIGURATION OPTIONS

- "-" Standard. No additional configuration  
Nominal output voltages and no options
- "C" Conformal Coating
- "P" Preset. Voltage Adjustments, Series, Parallel Outputs
- "R" Extra Ruggedisation for Shock and Vibration
- "S" Conformal Coating and Extra Ruggedisation for Shock and Vibration

#### INPUT CONNECTOR CONFIGURATOR OPTIONS

- "0" Standard IEC Input Connector
- "D" Input Cable Option

#### REVERSE FAN AND LEAKAGE CURRENT OPTIONS

- "0" Standard Thermal Signals + Fan Fail Signal Included
- "1" Standard Thermal Signals + Fan Fail Signal Included (Xgen models only)
- "2" Reverse Fan (Includes "0")
- "3" Reverse Fan, Standard Thermal Signals + Fan Fail Signal Included (Xgen models only)
- "4" 150uA Leakage Current\*(medical models only, Includes"0")
- "5" 150uA Leakage Current\*, Standard Thermal Signals + Fan Fail Signal Included (Xgen models only)
- "6" 150uA\* + Reverse Fan (medical versions only, Includes"0")
- "7" 150uA Leakage Current\*, Reverse Fan, Standard Thermal Signals + Fan Fail Signal Included (Xgen models only)

### Specifying & Ordering Configured Power Supplies

Configured Units may be specified and ordered using the part numbering system shown opposite. At our configuration centre we will assemble the Power Supply as specified by you accounting for slot preferences and also for preferred settings (Voltage/Series/Parallel etc), and also incorporating any Options required.

Configuration example for UltiMod: part number UX4CGD0-D4 specifies the following product;

- UX4 powerPac – 600W (Medical & Industrial)
- Slot 1: XgC: 36V/5.6A powerMod
- Slot 2: XgG: 2.5V/40A powerMod
- Slot 3: XgD: 48V/4.2A powerMod
- Slot 4: empty
- Option D (input cable) & Option 4 (150uA Leakage current)

Configuration example for XF: part number XFC2DK4BHS01 specifies the following product;

- XFC501 powerPac - 1000W (includes options S & 1 as standard)
- Slot 1: Xg2C 5V/40A powerMod
- Slot 2: XgDC 48V/4.2A powerMod
- Slot 3: XgKC 24V/9.2A powerMod
- Slot 4: Xg4C 24V/10A powerMod
- Slot 5: XgBC 24V/8.3A powerMod
- Slot 6: XgHC 5V/36A powerMod

Configuration example for Xgen: part number XVD2345F0-D4 specifies the following product;

- XVD powerPac - 1200W (Medical)
- Slot 1: Xg2:5V/40A powerMod
- Slot 2: Xg3:12V/20A powerMod
- Slot 3: Xg4:24V/10A powerMod
- Slot 4: Xg5:48V/6A powerMod
- Slot 5: XgF:24V/3A, 24V/3A powerMod
- Slot 6: empty
- Option D (input cable) & Option 4 (150uA Leakage current)

\*UltiMod comes with Thermal and Fan Fail signals as standard

\*With 150uA Leakage Current (Option 4) some external filtering may in certain cases be needed to meet system level EMC specifications. Consult Excelsys for support.

## Section 3.5 Accessories

### Input Cable (Option D)

Excelsys modular power supplies are also available with an input cable connection option allowing greater flexibility when mounting the power supply in the system. Individually insulated input cables are 300mm in length and come supplied with Faston connectors.

### IEC to Screw Terminal Adaptor

Some applications may require a screw terminal input rather than the standard IEC320 connector provided with Excelsys modular power supplies. For such applications, Excelsys can offer the XE1, the IEC to Screw terminal adaptor accessory plug. This is a press fit connector that plugs securely into the *powerPac* and provides the system integrator with screw terminals for mains connection (not available on XCE, XVE, XMD, XLD, XF).

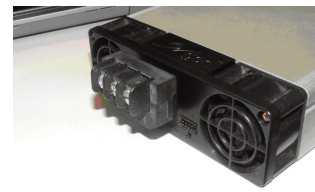

### IEC to Faston Adaptor

For application that require Faston connectors on the AC input, Excelsys recommends IEC to Faston/Terminal Lugs Schurter P/N 4788.8000.



## Modular Power Supply Mounting Options

### 1. Base Plate Mounting

The unit can be mounted in the system via the mounting holes present on the UltiMod and Xgen base. See mechanical drawings for mounting hole positions. Use M3 mounting screws. Ensure that maximum screw penetration from base does not exceed 6mm.

### 2. Fleximount System A

Using the side mounting clips accessory shown, the clip can be positioned at the user defined position along the slide rail on the side of the UltiMod/Xgen. The clip is then mounted to the system base plate. Use M3 mounting screws to fix mounting clip to system base. Excelsys part number Z165.

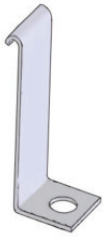

### 3. Fleximount System B

Using the slide rail on side of the UltiMod/Xgen, self-clenching studs can be placed at a user defined position. Excelsys recommends: PEM<FH-M4-X or FH-832-X or equivalent.

### LK1 for Current Share on powerMods XgA to XgD

To implement current share on powerMods XgA to XgD, The Excelsys LK1 connector must be inserted. Excelsys recommends the use of Harwin M7567-05 (Jumper Socket, Black 2.54mm 2 way connector). See picture below for details on where to inset LK1.

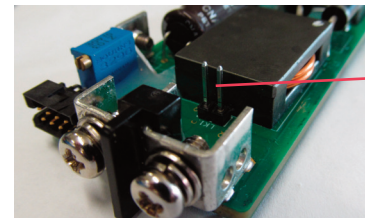

LK1 (Attach jumper here)

**Recommended Jumper for LK1: HARWIN M7567-05**  
(Jumper Socket, Black, 2.54mm, 2-way)

## XS1 & XP1 Bus Bars

### Parallel and Series Links

XP1 Parallel bus bar. When connecting *powerMods* in parallel for higher current outputs, the XP1 bus bar can be used. This can also be used to create common grounds between outputs.

Please follow the procedure for parallel connection of *powerMods* in Section 4.6



XS1 Series bus bar. When connecting *powerMods* in series for higher voltage outputs, the XS1 bus bar can be used. This can also be used to create common grounds between outputs. Please follow the procedure for series connection of *powerMods* in Section 4.6

Full mechanical details of all drawings available on request.

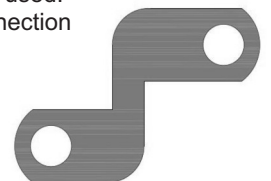

## Section 4.0 MODULAR POWER SUPPLIES

This Modular Power Supply Designers' Manual has been prepared by Excelsys experts to assist qualified engineers and technicians in understanding the correct system design practices necessary to achieve maximum versatility and performance from any of the UltiMod and Xgen range of Modular Configurable power supplies.

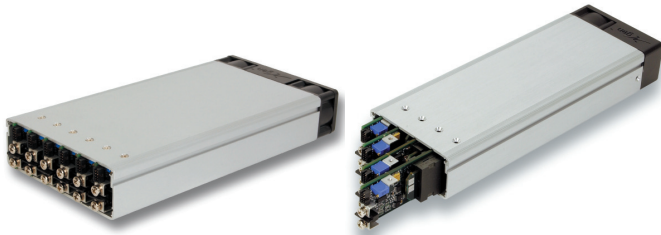

### Section 4.1 Overview of UltiMod and Xgen

The UltiMod and Xgen series allows users to instantly configure high efficiency, off-line power supplies. Although very small in size, the Excelsys range of modular power supplies provide up to 1340W of simultaneous output power.

A complete power supply is configured by selecting and inserting up to six DC output modules called *powerMods* into a *powerPac* to build a power supply. This offers the advantages of a custom supply, but is assembled from standard and modular building blocks continuing the Excelsys tradition of industry leading configurable power supplies.

Manufactured in world class power supply production facilities, the UltiMod and Xgen are completely user configurable. If output requirements change, i.e. more power or a different output voltage is needed, upgrading is easy: simply unlock a single screw and replace the slide-in *powerMod* assembly with the preferred alternative. Allowing additional flexibility, *powerMods* can be connected in parallel to increase output power, or in series for higher voltages (subject to staying within isolation ratings and giving due consideration to any SELV requirements).

A user-friendly interface on connector J3 of each *powerMod* provides control and output sequencing capability, in addition to useful status indicators.

The plug-together architecture facilitates 'instant' custom power solutions with industry leading 17W/in<sup>3</sup> power density and up to 92% conversion efficiency.

### Section 4.2 Installation Considerations

The UltiMod and Xgen series models may be mounted on any of three surfaces using standard M4 screws. The chassis comes with four mounting points on the base. Maximum allowable torque is 2Nm. The maximum penetration depth is 6mm. Additionally, the fleximount™ system on both side walls of the *powerPac* chassis facilitates flexible mounting.

When selecting a mounting location and orientation, the unit should be positioned so air flow is not restricted. Maintain a 50mm minimum clearance at both ends of the power supply and route all cables so airflow is not obstructed. The standard unit draws air in on the input side and exhausts air out the load side. If airflow ducting is used, avoid sharp turns that could create back pressure.

Avoid excessive bending of output power cables after they are connected to the *powerMods*. For high current outputs, use cable-ties to support heavy cables and minimise mechanical stress on output studs. Be careful not to short-out to neighboring output studs. *PowerMods* are supplied with spring washers on all output screws. These (or equivalents) should be used and thread locking compounds are not required. The maximum torque recommended on output connectors is 2Nm. Avoid applications in which the unit is exposed to excessive shock or vibration levels that exceed the specified levels. In such applications, a shock absorption mounting design is required.

### Section 4.3 Mounting Considerations

- Always fill all output slots of the UltiMod or Xgen. If a slot is not filled with a *powerMod*, it should be filled with an Empty Slot Cover (part numbers XB1, XB2 or XB3). Empty Slot covers are plastic assemblies whose main function is to fill up an empty slot. Excessive airflow escape from an empty slot may degrade thermal performance and result in overheating and damage to the UltiMod unit. Refer to Section 4.11 for optimal positioning of *powerMods* to equalize airflow and prevent foreign objects from entering *powerPac*
- Do not unplug *powerMods* while input power is applied to the *powerPac*. The UltiMod and Xgen are not designed for hot-plug applications.
- Do not restrict airflow to the unit. The cooling fan draws air into the unit and forces it out at the output terminals.
- Always ensure that output screws are properly torqued to maximum 2Nm before applying power to the *powerPac*.
- Secure modules in *powerPac* chassis to a torque value of maximum 2Nm
- Positive and negative power cables should be arranged as a twisted pair to minimise inductance.
- Wait 4 minutes after shutting off power before inserting or removing *powerMods*.
- UltiMod and Xgen assemblies do not have user serviceable components. They must be returned to the factory for repairs. Contact Customer Service for a RMA number before returning the unit. Do not attempt to repair or modify the power supply in any manner other than the exchange of *powerMods* as described in this Designers' Manual.
- Use proper size wires to avoid overheating and excessive voltage drop.

### Section 4.4 Theory of Operation

The Xgen and UltiMod platforms are comprised of an appropriate *powerPac* and a selection of *powerMod* DC output modules selected to deliver the exact volts and amps requirements of the the system designer. See Operational Block Diagram.

The *powerPac* consists of a fan-cooled semi-enclosed chassis containing circuitry for an off-line single phase AC front end, EMI filter, cooling fan, customer interface and associated housekeeping circuits. Input AC mains voltage (L1/N, L2 and GND) is applied to an IEC320 type input connector and then through an EMI filter designed to meet EN 55022 Class B (for Industrial models).

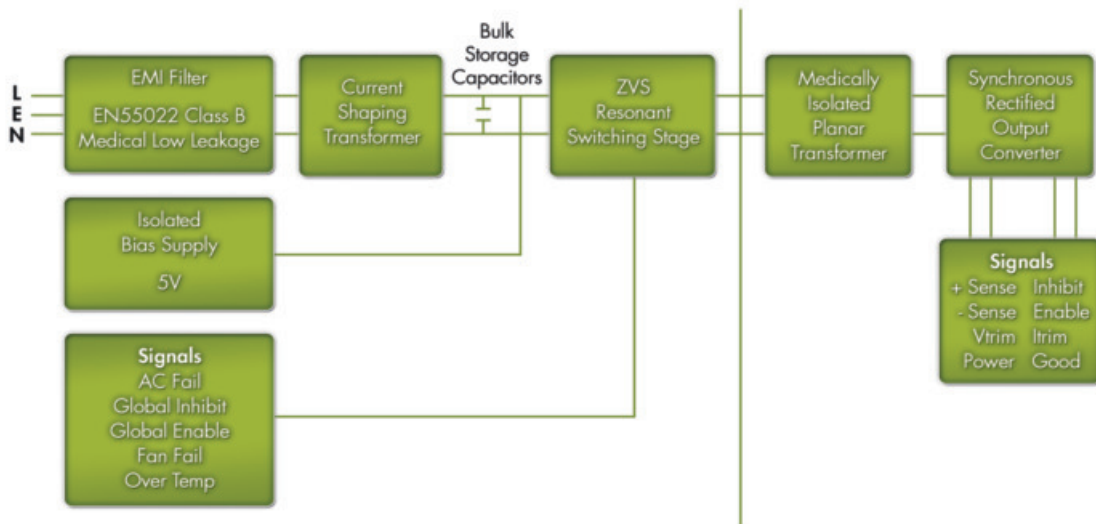

Operational Block Diagram

For medical applications, the EMI filter also ensures the power supply meets the low earth leakage current requirements of EN60601-1 3rd Edition (Medical supplies only).

This stage is then followed by a high frequency switching input current shaping boost converter feeding the ZVS (Zero Voltage Switching) resonant switching stage. The ZVS stage supplies power to a variety of *powerMod* assemblies that provide the desired low voltage, regulated outputs. Conversion in the output assemblies is achieved by the most advanced high efficiency converters resulting in reduced size for magnetics and capacitors; excellent line and load regulation; wide adjustment range for output and low EMI/RFI emission.

At initial power-up, the outputs are disabled to eliminate inrush current and a low-power flyback converter operating with PWM current mode control converts the high voltage DC bus into regulated low voltage to power the internal housekeeping circuits and cooling fans. Once the bus potential is within operating parameters, the AC Fail signal is deactivated indicating that the input power is ok, and allows the installed *powerMod* outputs to come up. An auxiliary isolated bias supply of 5 VDC is provided for peripheral use on interface connector J2. In the case of medically approved supplies, this bias supply has medical isolation (4000VAC).

## Section 4.5

### Configuration (and Reconfiguration)

See Online Configuration tool:  
[http://www.excelsys.com/xgen\\_configurator/configure.html](http://www.excelsys.com/xgen_configurator/configure.html)

*powerMods* may be easily added, replaced, or moved by sliding the assemblies in or out of the *powerPac* chassis.

Prior to removing or installing a *powerMod*, remove power from the *powerPac* and wait 4 minutes. Failure to do so can result in personal injury and/or damage to the supply. Take standard ESD precautions when handling *powerMods*.

Configuring the UltiMod and Xgen is as easy as 1,2,3!

1. Select the appropriate *powerMods* for your application.
2. Calculate your power requirements.
3. Select your appropriate *powerPac* for power and application from the wide range of *powerPacs*.

### Removing *powerMods*

*powerMods* may be removed by removing the screw on the top surface. Once this screw has been removed the *powerMod* will

slide out of the chassis. Once a *powerMod* has been removed, the empty slot MUST be filled with either another *powerMod* or an empty slot cover. If the slot is left empty, it will provide an air-flow escape and may cause inadvertent thermal shutdown of the unit to equalize airflow and prevent foreign objects from entering the *powerPac*.

### Installing *powerMods*

*powerMods* may be installed in empty slots by simply sliding in the new *powerMod*, pushing the *powerPac* 'home' until the mounting bracket lines up with the hole in the Top Panel, then securing the module with the M3 x 6 countersunk screw provided tighten to 2Nm max. Power and interface connections can be made after the *powerMod* has been installed.

*powerMods* may be paralleled for more power using bus bars (Paralleling Links) across the positive and negative output terminals. They can be series connected for applications requiring higher voltages.

## Section 4.6

### *powerMod* Operation

The UltiMod and Xgen series of products have been designed to allow maximum flexibility in meeting the unique requirements of system designers. The inherent flexibility resulting from modular concepts allows users to configure solutions with multiple outputs that can be individually controlled.

### Voltage Adjustment

The UltiMod and Xgen series outputs boast very wide adjustment ranges on the *powerMod*: Voltage setting and dynamic voltage adjustment can be achieved via the on board potentiometer and the J3 signals connector.

**Type A: *powerMods***  
 XgA to XgE  
 XgG to XgT  
 Xg1 to Xg7

**Type B: *powerMod***  
 XgF/Xg8

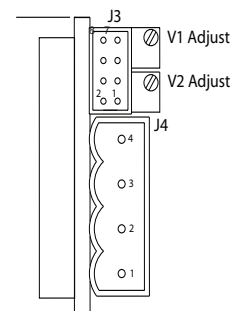
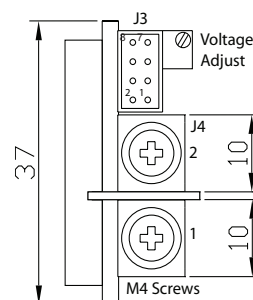

## Designer Manual

Voltage adjustment may be achieved by

1. Front Panel potentiometer adjustment allowing users to set the output voltage to their required level.
2. Remote voltage adjustment using external resistor or potentiometer for modules XgG-XgT and Xg1-Xg5.
3. Remote voltage adjustment using an external voltage source for modules XgG-XgT and Xg1-Xg5.

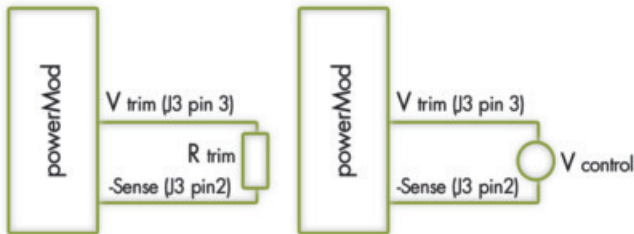

**Remote Output Voltage Adjustment of powerMods**

Excelsys have developed calculators that assist our customers in defining the external resistor values and external control voltages to allow users to set and control the output voltages. These are available to download from:

<http://www.excelsys.com/technical-support/>

Important: when using an external voltage source to set or adjust the output voltage, the control voltage must not exceed 2.5VDC.

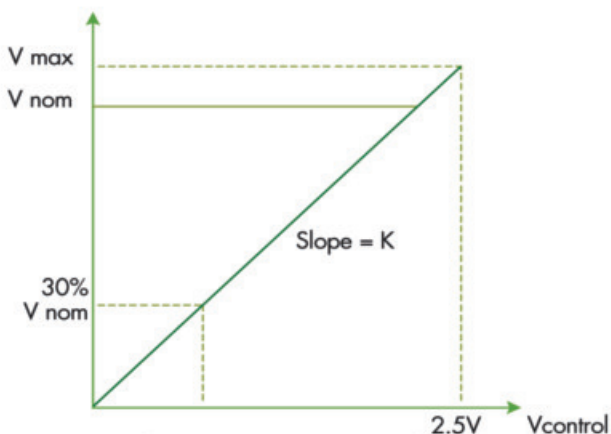

**Remote Output Voltage Adjustment of powerMods**

Go to the support section of our website to download calculators and module specific K values:

<http://www.excelsys.com/technical-support/>

Modules XgM-XgQ can be dynamically trimmed to 1V. Contact Excelsys for applications support.

### Current Limit Adjustment

A variety of over current protection methods are possible with the UltiMod and Xgen series. powerMods Xg1 to Xg5 and XgG to XgT can have Straight-line current limit or Foldback current limit. See *powerMod* Summary Specifications table for nominal current limit values.

Simple external application circuits may be used to achieve programmable foldback current and user programmable current limit levels (reduced). The default current limit characteristic is Straight Line Current Limit.

### Programming Current Limit

The current limit can be programmed to your requirements (in both Straight line and Foldback modes).

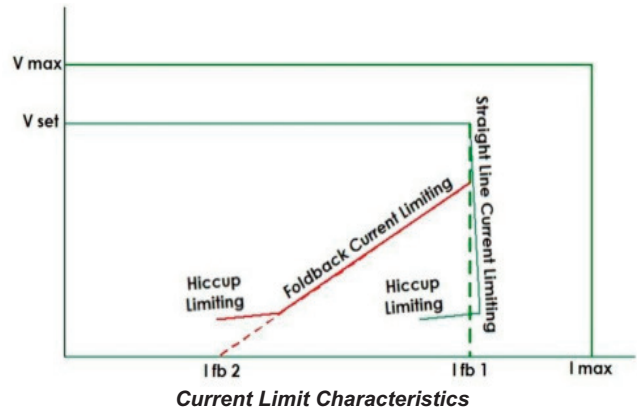

### Straight line Current Limit

The onset of current limit can be programmed using an external voltage source resistor/potentiometer. Connection between the Itrim pin (J3 pin4) and the -Vout (J4) terminal will set the current limit to the desired level.

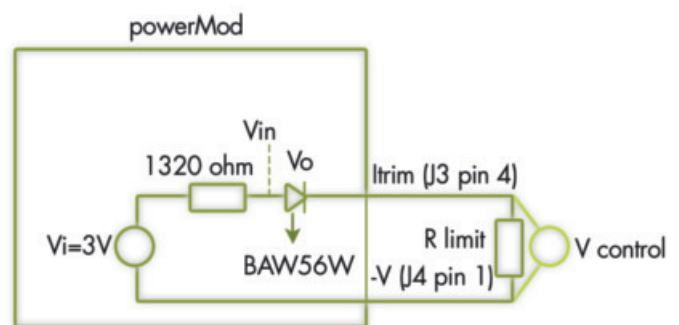

**Current Limit Programming**

Easy to use calculators have been developed to help users define the external resistor values and external control voltages to allow users to set and control the output current limit. These are available to download from <http://www.excelsys.com/technical-support/>

Important: when using an external voltage source for set/adjust the output current, the control voltage must not exceed 2.5VDC.

### Foldback current Limit Programming

Foldback Current Limit can be achieved using the circuit below

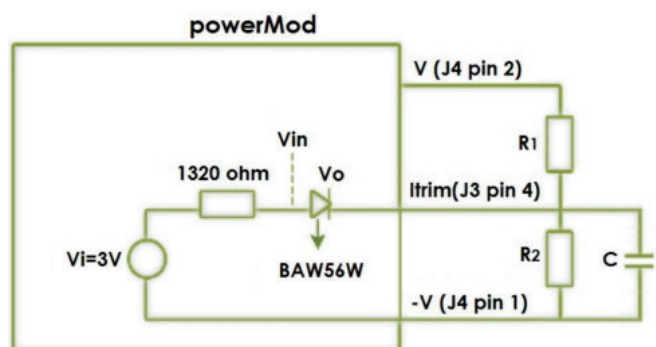

**Foldback Current Limit**

Calculators have been developed to help users define the external resistor values and to allow users to set and control the foldback current limit. These are available to download from the support section of our website;

<http://www.excelsys.com/technical-support/>

Model	Vnom (V)	Set Point Adjust Range (V)	Current Limit Foldback	Dynamic Vtrim Range (V)	I <sub>max</sub> (A)	Power (W)	OVP 1 Tracking % of V <sub>set</sub>	Remote Sense (V)	Power Good
XgA	12.0	10.8-15.6	-	-	12.5	150	-	-	-
XgB	24.0	19.2-26.4	-	-	8.3	200	-	-	-
XgC	36.0	28.8-39.6	-	-	5.6	200	-	-	-
XgD	48.0	38.5-50.4	-	-	4.2	200	-	-	-
XgE	24.0	5.0-28.0	No	-	5.0	120	No	-	Yes
XgF <sub>V1</sub>	24.0	5.0-28.0	No	-	3.0	72	No	-	Yes
XgF <sub>V2</sub>	24.0	5.0-28.0	No	-	3.0	72	No	-	Yes
XgG	2.5	1.5-3.6	Yes	1.15-3.6	40.0	100	105-170%	0.5	Yes
XgH	5.0	3.2-6.0	Yes	1.5-6.0	36.0	180	105-170%	0.5	Yes
XgJ	12.0	6.0-15.0	Yes	4.0-15.0	18.3	220	105-170%	0.5	Yes
XgK	24.0	12.0-30.0	Yes	8.0-30.0	9.2	220	105-170%	0.5	Yes
XgL	48.0	28.0-58.0	Yes	8.0-58.0	5.0	240	105-170%	0.5	Yes
XgM	5.0	3.2-6.0	Yes	1.0-6.0	40.0	200	105-170%	0.5	Yes
XgN	12.0	6.0-15.0	Yes	1.0-15.0	20.0	240	105-170%	0.5	Yes
XgP	24.0	12.0-30.0	Yes	1.0-30.0	10.0	240	105-170%	0.5	Yes
XgQ	48.0	24.0-58.0	Yes	1.0-58.0	6.0	288	105-170%	0.5	Yes
XgR	24.0	12.0-30.0	Yes	8.0-30.0	8.0	240	105-170%	-	Yes
XgT	48.0	28.0-58.0	Yes	8.0-58.0	6.0	288	105-170%	-	Yes
Xg1	2.5	1.5-3.6	Yes	1.15-3.6	50.0	125	105-170%	0.5	Yes
Xg2	5.0	3.2-6.0	Yes	1.5-6.0	40.0	200	105-170%	0.5	Yes
Xg3	12.0	6.0-15.0	Yes	4.0-15.0	20.0	240	105-170%	0.5	Yes
Xg4	24.0	12.0-30.0	Yes	8.0-30.0	10.0	240	105-170%	0.5	Yes
Xg5	48.0	28.0-58.0	Yes	8.0-58.0	6.0	288	105-170%	0.5	Yes
Xg7	24.0	5.0-30.0	No	-	5.0	120	No	-	Yes
Xg8 <sub>V1</sub>	24.0	5.0-28.0	No	-	3.0	72	No	-	Yes
Xg8 <sub>V2</sub>	24.0	5.0-28.0	No	-	3.0	72	No	-	Yes

**PowerMod Summary Specifications**

**Over Voltage Protection (OVP)**

Over-voltage protection is implemented on each powerMod output. OVP level is fixed relative to V<sub>max</sub> (105-170%). OVP is latching and it may be reset by removing and reinstating AC power from the powerPac input.

**Power Limit**

Each powerMod has a number of levels of protection in order to ensure that UltiMod or Xgen is not damaged if used in overload conditions. Refer to Output powerMod Power Limit graph

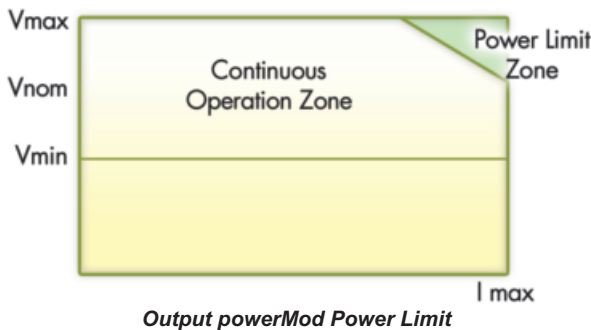

When V<sub>set</sub> is less than or equal to V<sub>nom</sub>, current limit is employed at the current limit set point. However if V<sub>set</sub> is greater than V<sub>nom</sub>, the power limit is employed to ensure that the powerMods does not exceed its power rating. e.g. XgK is adjustable between 12V and 30V. I<sub>max</sub> is 9.2A. Power rating is 220W. At 24V the powerMod can deliver 9.2A continuously, i.e 220W. At 30V, the powerMod can still deliver 220W, however this equates to 7.33A continuous current.

**Remote Sense (powerMods XgG-XgQ and Xg1-Xg5 only)**

To compensate for voltage drops in the output leads, use remote sensing. Remote sensing is available on all single output and on the first output (V1) of the dual output module.

Remote sensing may be implemented by connecting the Positive Sense pin (J3 pin1) to the positive side of the remote load and the Negative Sense pin (J3 pin2) to the negative side of the remote load. The maximum line drop, which can be compensated for by remote sensing, is 0.5V, subject to not exceeding the maximum module voltage at the output terminals.

Observe the following precautions when remote sensing:

1. Use separate twisted pairs for power and sense wiring.
2. Route the sensing leads to prevent pick up, which may appear as ripple on the output.
3. Never disconnect the output power rail with the sensing still connected to the load.

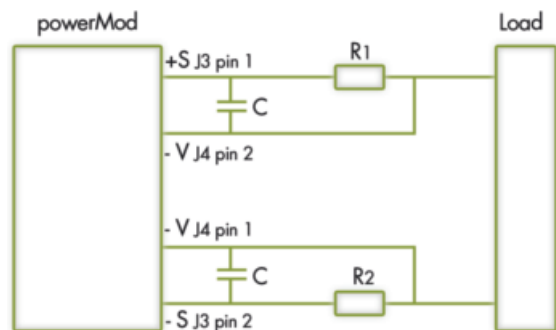

**Remote Sense of Output Voltage**



## Designer Manual

In certain applications where there is a high dynamic impedance along the power leads to the sensing point, remote sensing may cause system instability. This system problem can be overcome by using resistors in the sense leads (Positive sense lead:  $R1 = 100\text{ohm}$  , Negative sense lead:  $R2=10\text{ohm}$  ), together with local AC sensing, by using  $22\mu\text{F}$  capacitors between the remote sense pins and the output terminals. The resistance of the power cables must be so that the voltage drop across the cables is less than ( $R_{\text{cable}}$ )  $0.5\text{V}$  (to ensure remote sensing operates correctly).

$$R_{\text{cable}} < \frac{0.5}{I_{\text{out}}}$$

e.g. for an XgH,  $5\text{V}/36\text{A}$ . The  $R_{\text{cable}}$  must be less than  $13.9\text{mohms}$ .

### Measurement of Ripple & Noise

As with all switched mode power supplies, it is important to ensure that the correct method is used to measure ripple & noise. Care should be taken to ensure that a loop antenna is not formed by the tip and ground lead of the oscilloscope probe as this would lead to erroneous readings consisting mainly of pickup from remnant radiation in the vicinity of the output connectors. Excelsys recommends the use of an x1 probe with the ground sheath of the probe tip used for ground connection.

In some applications, further erroneous readings may result from CM currents. These can be reduced by looping a few turns of the scope lead through a suitable high permeability ferrite ring.

As most loads powered by a power supply will have at least small values of differential capacitors located near the load, Excelsys also recommends the use of small value of capacitance (approx  $1\mu\text{F}$ ) positioned at the point of measurement.

### Minimising System Noise

There are a number of causes of poor system noise performance. Some of the more common causes are listed below.

- Insufficient de-coupling on the PCB or load.
- Faulty wiring connection or poor cable terminations.
- Poor system earthing, system level grounding and shielding issues

There are some simple steps to eliminate, reduce or identify the causes of high frequency noise;

- Is the noise conducted or radiated? If changing the position of the power supply or screening improves performance, the noise is likely to be radiated. See Section 7.3 (EMC Characteristics).
- Twist all pairs of power and sense cables separately.
- Ground connections (zero Volt) should be made with the shortest possible wiring via a capacitor to the nearest point on the chassis. See Excelsys Application Note: AN1105 on website: <http://www.excelsys.com/wp-content/uploads/2011/09/ApplicationNoteAN1105-RippleandNoise1.pdf>

### Series Connection of powerMod outputs

It is possible to connect modules in series to increase output voltage. Outputs are rated SELV (Safety Extra Low Voltage), that is, that output voltages are guaranteed to be less than  $60\text{V}$ , if putting modules in series please take appropriate precautions.

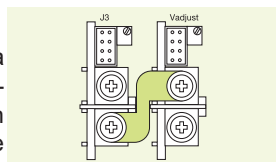

Series Links available.  
Part Number XS1

It is good practice to stack modules with similar output current limits, so that in case of short circuit the outputs collapse together.

If remote sensing is required, the exterior sense connections should connect to the load at point of use, and the interior connections to the local sense. Special links for series connection modules (part number XS1) to reduce wiring complexity can be specified and fitted by the installer or added at the factory.

### Parallel Connection for PowerMods

To achieve increased current capacity, simply parallel outputs using the standard parallel links. Excelsys 'wireless' sharing ensures that current hogging is not possible.

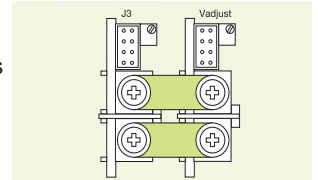

Parallel Links available to order.  
Part Number XP1

### To parallel connect outputs: XgG-XgQ and Xg1-Xg5

- Switch on IShare switch to ON.
- Connect Negative Parallel Link.
- Adjust output voltages of *powerMods* to within  $5\text{mV}$  of each other using differential techniques.
- Connect Positive Parallel Link.



DIP Switch for Current Share & Inhibit/Enable for *powerMods* XgG to XgL and Xg1 to Xg5

### To parallel connect outputs: XgA-XgD

- Add jumper to current share header LK1 for *powerMods* XgA-XgD.
- Connect Negative Parallel Link.
- Adjust output voltages of *powerMods* to within  $5\text{mV}$  of each other using differential techniques.
- Connect Positive Parallel Link

### LK1 for Current Share on powerMods XgA to XgD

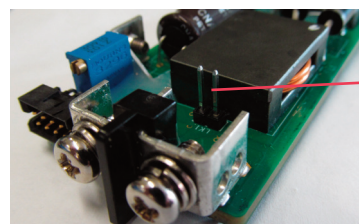

Recommended Jumper for LK1: HARWIN M7567-05  
(Jumper Socket, Black, 2.54mm, 2-way)

### powerMod Start-Up and Shutdown

*powerMods* are designed such that when input power is applied, all outputs rise to their set point voltage simultaneously. Likewise, when input power is removed all outputs commence to drop simultaneously and reach Zero potential simultaneously.

Outputs can be sequenced using the enable function in order to allow controlled start up if required. See plots for start-up and shutdown characteristics.

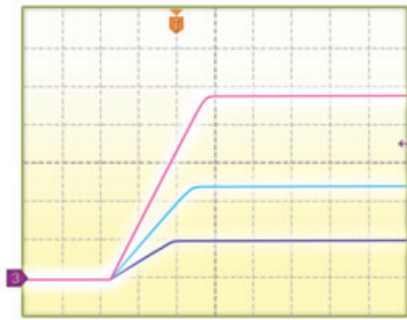

Output powerMod Start-Up

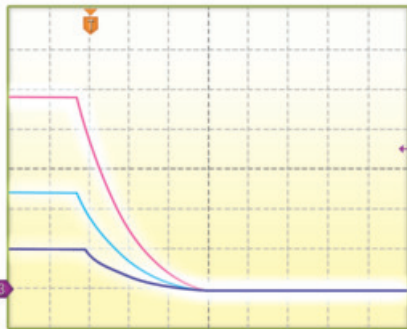

Output powerMod Shutdown

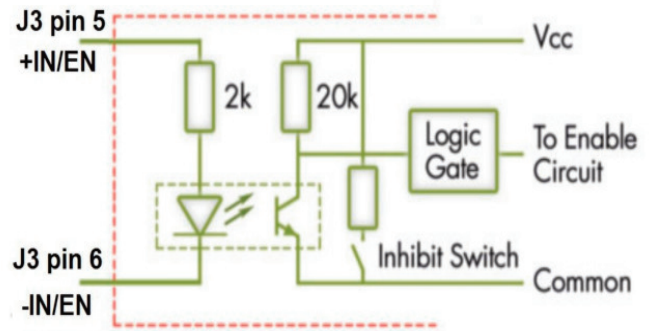

XgG-XgQ Remote Inhibit/Enable of Output Xg1-Xg5

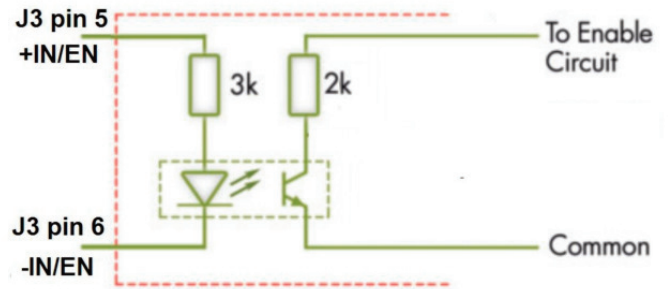

XgA-XgD Remote Enable/Disable of Output

## Section 4.7

### PowerMod Signals

#### PowerMod Enable/Inhibit XgE-XgT and Xg1-Xg8

Each *powerMod* may be enabled/inhibited by means of an appropriate signal applied to an opto-isolated input (see figure alongside & table below)

#### XgG-XgT

Apply a signal to the opto-isolated input on J3 pin 5 (positive) and J3 pin 6 (negative), on *powerMods* XgG to XgL

#### Xg1-Xg5

Apply a signal to the opto-isolated input on J3 pin 5 (positive) and J3 pin 6 (negative), on *powerMods* Xg1 to Xg5

#### XgA-XgD

Inhibit is available by applying an appropriate signal to an opto-isolated input on J3 pin 5(positive) and J3 pin 6 (negative)

#### XgE and Xg7

Direct access to the output buck controller is given to the user via J3 pin 7 and J3 Pin 8. Reducing the voltage to less than 0.8V between J3 pin 7 and J3 pin 8 will inhibit the module.

#### XgF and Xg8

Direct access to the output buck controller is given to the user via J3 pin 3 and J3 Pin 4 for OP1 and J3 pin 7 and J3 pin 8 for OP2 Reducing the voltage to less than 0.8V between these pins will inhibit the corresponding module output.

When inhibited the output voltage of the *powerMod* will be fully inhibited to 0V. Turn-on delay from AC in and Global Enable is typically 2ms but is load dependant.

	XgA to XgD	XgG to XgT	XgE/Xg7, XgF/Xg8
Maximum signal input voltage	17V	12V	0.8V
Minimum signal input voltage	4V	3V	0V
Minimum current required is	1.7mA	1.7mA	

#### XgG-XgT and Xg1-Xg5

*PowerMods* can be configured to be normally ON or normally OFF the by appropriate setting of the DIP switch on the *powerMod*(default mode is normally ON as in figure below). The *powerMod* will deliver output voltage when mains is applied (and the powerPac is enabled). The *powerMod* requires an external 5V signal (between +IN/EN and -IN/EN) to disable the output pins. This may be reversed (normally OFF and requiring a signal to turn ON) by setting of the Inhibit dip switch to the OFF position

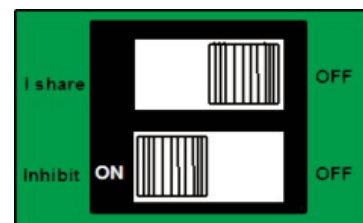

DIP Switch for Current Share & Inhibit/Enable for *powerMods* XgG to XgT

#### PowerMod Power Good Signal (XgE-XgQ and Xg1-Xg8)

Each *powerMod* contains an internal comparator which monitors the output voltage and determines whether this voltage is within normal operation limits. When the output voltage is within normal limits, the Power Good signal is activated (see below for signal descriptions).

#### For XgG-XgQ and Xg1-Xg5

The open collector of an opto-isolator is available on J3 pin 7 and the emmitter on J3 pin 8. (opto-transistor ON= Power-Good).

#### For XgE and Xg7

The open collector of an opto-isolator is available on J3 pin 6 and the emmitter on J3 pin 5. (opto-transistor ON= Power-Good).

## Designer Manual

### For XgF and Xg8

The open collector of an opto-isolator is available on J3 pin 6 and J3 pin 5 for OP1 and J3 Pin 2 and J3 Pin 1 for OP2 (opto-transistor ON= Power Good).

Maximum collector current is 2mA.  
Maximum Collector voltage is 30V.  
 $t7 < 30\text{ms}$   
 $t8 < 30\text{ms}$

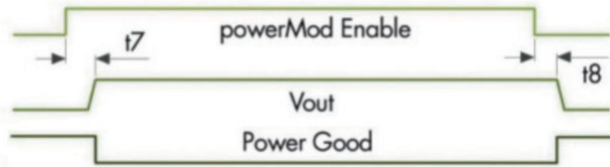

**Output powerMod Signals**

(In this figure the Power Good open collector has been pulled up to a 5V signal with a 4k resistor).

### powerMod LED Indicator

The LED indicator on each *powerMod* module gives a visual indication of the information contained in the Power Good signal above.

## Section 4.8

### powerPac Operation

The *powerPac* provides the front end input power to the *powerMods*. This is available in two package sizes and a number of power ratings. See Section 4.11, Power Ratings for more detail.

### Bias Voltage

A SELV isolated bias (always on) voltage of 5V nominal @ 500mA (250mA on XF, XCE and XVE models) is provided on J2 pin 2 relative to J2 pin 1 (common) and may be used for miscellaneous control functions. For medical applications, this bias supply voltage has 4000VAC isolation.

## Section 4.9

### powerPac (Global) Signals

#### AC Fail

AC Mains Fail signal is implemented by an open collector of an opto-isolator with a maximum sink current of 4mA. During normal operation the transistor is ON. When the input voltage is lost or goes below 80Vac, the opto-transistor is turned OFF at least 5mS before loss of output regulation (at nominal *powerMod* voltage or below)

In this figure the AC Fail open collector has been pulled up to a 5V signal with a 4k resistor.

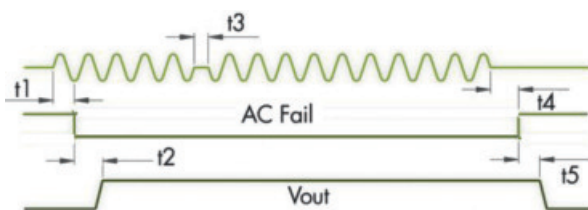

**Mains AC Fail Signal**

$$80 \text{ ms} < t1 < 600 \text{ ms}$$

$$80 \text{ ms} < t2 < 100 \text{ ms}$$

$$t3 = 10 \text{ ms}$$

$$t4 > 10 \text{ ms}$$

$$t5 > 2 \text{ ms}$$

### Global Inhibit

A global inhibit function may be implemented via simple contact closure as shown. This function inhibits ALL *powerMod* outputs except the auxiliary bias voltage. Global inhibit also shuts down the *powerPac* fans. When current flows through the internal opto-isolator the *powerPac* is turned off.

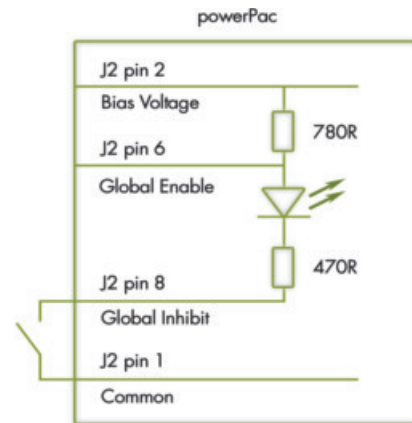

**Global Inhibit Using Bias Supply Voltage**

### Global Enable

A global enable function may be implemented via simple contact closure as shown in the diagram. Ensure that J2 pin 8 and J2 pin 1 are connected prior to contact closure, this mode by-passes the opto-isolator. This function enables ALL *powerMod* outputs and the *powerPac* fans when the switch is closed.

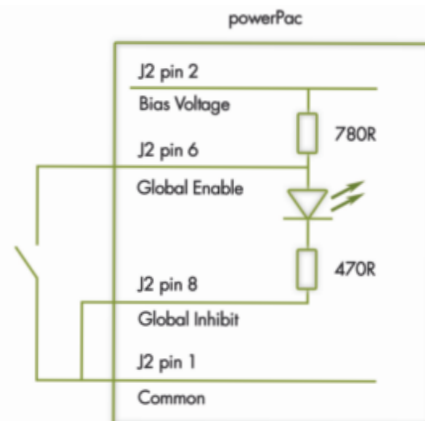

**Global Enable Using Bias Supply Voltage**

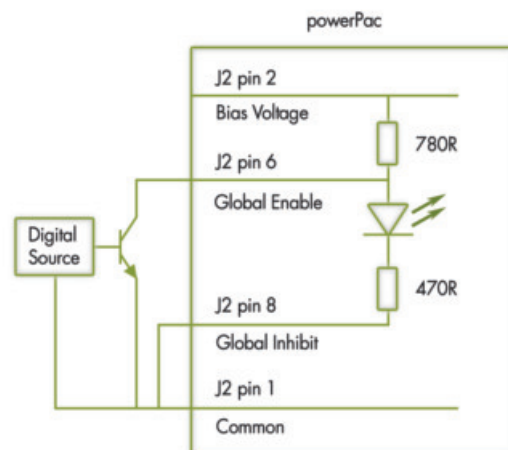

**Global Enable Using an External Signal**

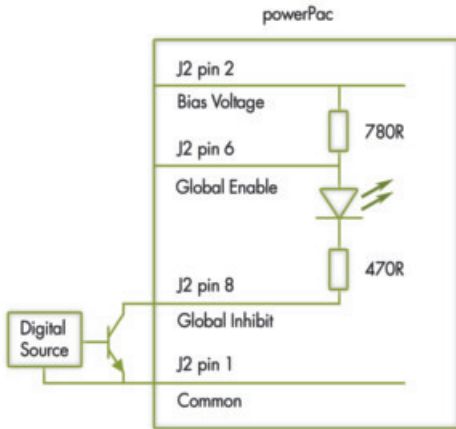

Global Inhibit Using an External Signal

## Section 4.10 powerPac Options

### Temperature Alarm

Open collector signal indicating that excessive temperature has been reached due to fan failure or operation beyond ratings. This signal is activated at least 10ms prior to system shutdown. (In this figure the Fan Fail and temperature alarms open collector have been pulled up to a 5V signal with a 4k resistor).

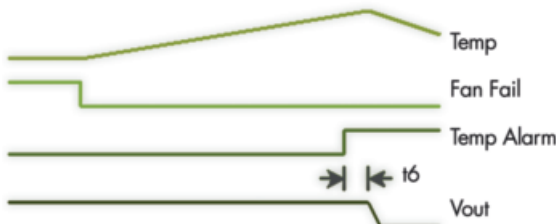

Over-temperature and Fan Fail

### Fan Fail

Open collector signal indicating that at least one of the powerPac fans has failed. This does not cause power supply shutdown. The power supply will continue to operate until 10ms after the temperature alarm signal is generated.

### Reverse Fan (Option 02)

UltiMod and Xgen are available with reverse air flow direction. This is ideal to expel air from the system and works particularly well with the internal fan cooling built into the overall system. Contact factory for details (standard airflow is from input connections to output connections).

### Ultra Low Leakage Current (Option 04)

The UltiMod and Xgen is available with the option of Ultra Low Earth Leakage Current of <math><150\mu\text{A}</math>. This is ideal for Medical applications using two power supplies or containing additional parts that contribute to the system Earth Leakage Current, ensuring system Earth Leakage current does not exceed levels defined in EN60601-1 and UL60601-1 2nd and 3rd Editions. Consult Excelsys for possible filter recommendations which may be needed to meet system level EMC specifications.

### Conformal Coating (Option C)

UltiMod and Xgen is available with conformal coating for harsh environments and MIL-COTs applications. It is IP50 rated against dust and protected against vertical falling drops of water and non condensing moisture, e.g. UX6ABDDL0C0 is a conformal coated 1000W configured UltiMod. Conformal coating material is Humiseal 1A33: (polyurethane based and military qualified)

### Ruggedised (Option R)

UltiMod and Xgen are available with extra ruggedisation as standard for applications that are subject to extremes in shock and vibration. These parts have been tested on 3 axes, for a total of 300hours at 1.67g's rms and have been tested versus MIL-STD 810G., e.g. UX6ABDDL0R00 is a ruggedised 1000W configured UltiMod.

### Conformal Coated and Ruggedised Option (Option S)

UX6ABDDL0S00 is a ruggedised and conformal coated 1000W configured UltiMod.

### Input Cable Option (Option D)

Excelsys modular power supplies are also available with an input cable connection option allowing greater flexibility when mounting the power supply in the system. Individually insulated input cables are 300mm in length and come supplied with Faston connectors.

## Section 4.11 Power Ratings

When specifying an UltiMod or Xgen power supply in an application it is necessary to ensure that powerPacs and powerMods are operating within their power output capabilities, taking into account the Temperature Derating and Input Voltage Derating. The maximum permissible output power that may be drawn from any powerMod is given in the powerMod specification table in Section 4.6. Refer to derating Curves on Individual Datasheets for Line and Temperature derating for UltiMod and Xgen.

Refer to derating Curves on individual datasheets or on page 45 and 46 for Line and Temperature deratings for UltiMod and Xgen.

### PowerMod Positioning

PowerMod performance can vary depending on slot position. Please use our online configurator to determine the optimal configuration for your system. This is particularly important when paralleling modules. Visit our configurator here [http://www.excelsys.com/xgen\\_configurator/configure.html](http://www.excelsys.com/xgen_configurator/configure.html)

## Section 4.12 Acoustic Noise

UltiMod and Xgen power supplies can be used in a wide variety of applications. Certain applications are more sensitive to acoustic noise than others. The table below sets out the measured acoustic noise of the various versions of UltiMod and Xgen. All acoustic noise measurements have been conducted in an anechoic chamber at a distance of 1m.

Acoustic Noise measurements of powerPacs

4-Slot powerPac	[dBA]	amb [dBA]
XL, XM	45.8	27.4
UX4, XK, XR	39.8	27.5
Ultra Quiet, XT, XN	37.3	27.3
XLD, XMD	52.8	27.3
6-Slot powerPac	[dBA]	amb [dBA]
XC, XV, XH	49.5	27.3
UX6, XQ, XZ,	42.7	27.5
Ultra Quiet, XB, XW	38.3	27.4
XCE, XVE, XF	56.5	27.3



Ultra-high efficiency 1U size

**FEATURES**

- Single output: 24V, 36V or 48V
- EN60950 2<sup>nd</sup> Edition & EN60601-1 2<sup>nd</sup> and 3<sup>rd</sup> Edition
- Ultra high efficiency, >92%
- Low profile: 1U height (40mm)
- Convection Cooled 500W
- Fan Cooled 1000W (variable speed fan)
- 12V/300mA bias standby voltage provided
- Remote ON/OFF Signal
- Power Good Signal
- MIL810G
- 2 MOPP
- SEMI F47 Compliant
- Suitable for Type B and BF rated applications
- Optional I<sup>2</sup>C PMBus™ Communications
- Optional OR-ing Function
- 5 Year Warranty
- Adjustable output voltage
- 5000m altitude for EN60950 applications
- All models feature active power factor correction as standard
- Product Options: Conformal Coating, Low Leakage Current and Ruggedised

**APPLICATIONS INCLUDE**

- Industrial
- Test & Measurement
- Medical
- Hi-Rel COTS
- Communication

The Xsolo family of single output power supplies provides up to an incredible 1008W in an extremely compact package.

Available in two package types, the high efficiency Xsolo delivers an incredible **convection cooled 504W** in an open-frame U-channel form factor and up to **1008W in an enclosed, fan cooled chassis**.

The Xsolo platform comes with a host of features including: variable speed fan, 12V/300mA isolated bias supply, remote ON/OFF, output voltage control and parallel operation for higher power applications. Nominal output voltages are 24, 36V and 48V with wide adjustment ranges and user defined set-points. Xsolo carries **dual safety certification, EN60950 2<sup>nd</sup> Edition** for Industrial Applications and **EN60601-1 2<sup>nd</sup> and 3<sup>rd</sup> Edition** for Medical Applications, meeting the stringent creepage and clearance requirements, 4KVAC isolation and <300uA leakage current. Xsolo is designed to meet **MIL810G** and is also compliant with **SEMI F47** for voltage dips and interruptions as well as being compliant with all relevant EMC emission and immunity standards.

Optional features include I<sup>2</sup>C digital communications and OR-ing Function for N+1 redundancy. The product can also be conformal coated and ruggedised for use in harsh environments. With convection cooled power capability of over 500W, the Xsolo is ideal for use in a wide range of applications: industrial, Hi-Rel MIL-COTS applications, as well as acoustically sensitive laboratory and medical environments.



**XS Models**

	Model	Power (W)	Output Voltage	Output Current (A)	Medical Approval UL/EN60601-1 3rd edition	Industrial Approval UL/EN60950 2nd edition
XS	XS500-24	504	24	21.0	Yes	Yes
	XS1000-24	1008	24	42.0	Yes	Yes
	XS500-36*	504	36	14.0	Yes	Yes
	XS1000-36*	1008	36	28.0	Yes	Yes
	XS500-48	504	48	10.5	Yes	Yes
	XS1000-48	1008	48	21.0	Yes	Yes

	Model	Vnom (V)	Power (W)	Description	Set Point Adjust Range (V)	Dynamic Vtrim Range (V)	I <sub>max</sub> (A)	Remote Sense	Power Good
XS	XS500-24	24	504	Convection Cooled U-Channel	19-28	14-28	21.0	Yes	Yes
	XS1000-24	24	1008	Enclosed Fan Cooled	19-28	14-28	42.0	Yes	Yes
	XS500-36*	36	504	Convection Cooled U-Channel	26-40	20-40	14.0	Yes	Yes
	XS1000-36*	36	1008	Enclosed Fan Cooled	26-40	20-40	28.0	Yes	Yes
	XS500-48	48	504	Convection Cooled U-Channel	36-58	29-58	10.5	Yes	Yes
	XS1000-48	48	1008	Enclosed Fan Cooled	36-58	29-58	21.0	Yes	Yes

\*Contact Excelsys for availability of 36V models

Full part numbering information including product options and ordering information on page 65.

INPUT					
Parameter	Conditions/Description	Min	Nom	Max	Units
Input Voltage Range	Universal Input 47-440Hz	85		264	VAC
		120		380	VDC
Power Rating	XS500		504		W
	XS1000		1008		W
Input Current	XS500		5		A
	XS1000		10		A
Inrush Current	230VAC @ 25°C			25	A
Undervoltage Lockout	Shutdown	65		74	VAC
Fusing	XS500 250VAC		F8A HRC		
	XS1000 250VAC		F12A HRC		
OUTPUT					
Parameter	Conditions/Description	Min	Nom	Max	Units
Output Voltage Range	XS500/1000-24: Multi-turn potentiometer	19		28	VDC
	XS500/1000-24: Dynamic Vtrim range	14		28	VDC
	XS500/1000-36: Multi-turn potentiometer	26		40	VDC
	XS500/1000-36: Dynamic Vtrim range	20		40	VDC
	XS500/1000-48: Multi-turn potentiometer	36		58	VDC
	XS500/1000-48: Dynamic Vtrim range	29		58	VDC
Output Current Range	XS500-24			21	A
	XS1000-24			42	A
	XS500-36			14	A
	XS1000-36			28	A
	XS500-48			10.5	A
	XS1000-48			21	A
Load & Cross Regulation	For 25% to 75% load change			±0.2	%
	ORing Option			±0.4	%
Transient Response	For 25% to 75% load change Voltage Deviation Settling Time			2.5 500	% µs
Ripple and Noise	XS500/1000-24: 20MHz		240		mV pk-pk
	XS500/1000-36: 20MHz		360		mV pk-pk
	XS500/1000-48: 20MHz		480		mV pk-pk
Overvoltage Protection	XS500/1000-24: Latching	33	34	37	VDC
	XS500/1000-36: Latching	44	47	52	VDC
	XS500/1000-48: Latching	61	63	69	VDC
Overcurrent Protection	Straight line with hiccup activation at <30% of Vnom.	105	115	130	%
Line Regulation	For ±10% change from nominal line		±0.5		%
Remote Sense				0.5	VDC
Overshoot				2	%
Rise Time	Monotonic		3	5	ms
Turn-on Delay	From AC in		500	800	ms
	From Remote On/Off		10		ms
Hold-up Time	For nominal output voltages at full load.	17			ms
GENERAL					
Parameter	Conditions/Description	Min	Nom	Max	Units
Isolation Voltage	Input to Output	4000			VAC
	Input to Chassis	1500			VAC
	Output to Chassis	1500			VAC
Efficiency	230VAC, 1008W @ 24V/36V/48V		>92		%
Safety Agency Approvals	EN60601-1 2nd and 3rd Edition, cTUVus 60601-1 EN60950 2nd Edition, cTUVus 60950				
Leakage Current	264VAC, 60Hz, 25°C			300	µA
	264VAC, 60Hz, 25°C (Option 4)			150	µA
Signals	See Page 3				
Bias Supply	Always on, current 300mA, 50mA XS500		12.0		VDC
Weight	XS500		1.1		Kg
	XS1000		1.3		Kg
MTBF	Telecordia SR-332, 40°C ground benign, parts count.			550,000	Hours
EMC					
Parameter	Standard	Level		Units	
<b>Emissions</b>					
Conducted	EN55011, EN55022, FCC		Class B		
Radiated	EN55011, EN55022, FCC		Class B		
Harmonic Distortion	EN61000-3-2 Class A		Compliant		
Flicker & Fluctuation	EN61000-3-3		Compliant		
<b>Immunity</b>					
Electrostatic Discharge	EN61000-4-2		Level 2		
Radiated Immunity	EN61000-4-3		Level 3		
Fast Transients-Burst	EN61000-4-4		Level 3		
Input Line Surges	EN61000-4-5		Level 3		
Conducted Immunity	EN61000-4-6		Level 3		
Voltage Dips	EN61000-4-11, SEMI F47 Compliant.①		Compliant		
ENVIRONMENTAL					
Parameter	Conditions/Description	Min	Nom	Max	Units
Operating Temperature		-40		+70	°C
Storage Temperature		-40		+85	°C
Derating	See Page 62 for full temperature deratings				
Relative Humidity	Non-condensing	5		95	%RH
Shock and Vibration	Designed to meet MIL810G ②		55		G
Altitude	EN60601-1 Operational: 3000m, Storage 8000m			3000	m
	EN60950 Operational: 5000m, Storage 8000m			5000	m

## Section 5.2 Xsolo Derating Curves

The line voltage and temperatures derating curves for the XS500 and XS1000 are shown below.

The XS500 is a 500W convection cooled part. The graphs below show the output power ratings with no system air flow and with 10CFM of system air flow applied to the product.

Contact [support@excelsys.com](mailto:support@excelsys.com) for further information on the XS500 and XS1000 performance with system air flow applied to the product.

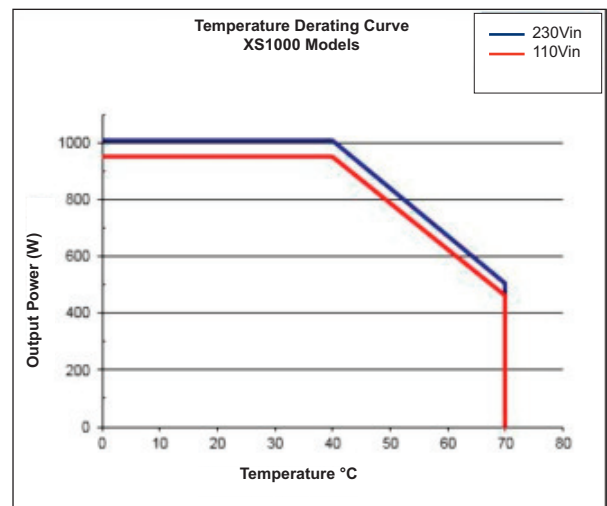
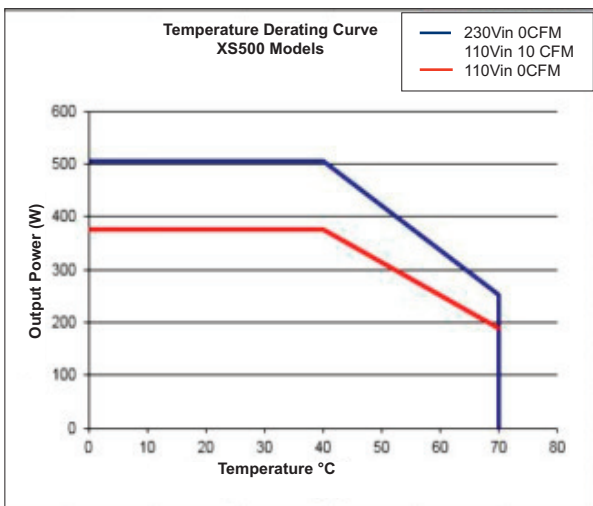
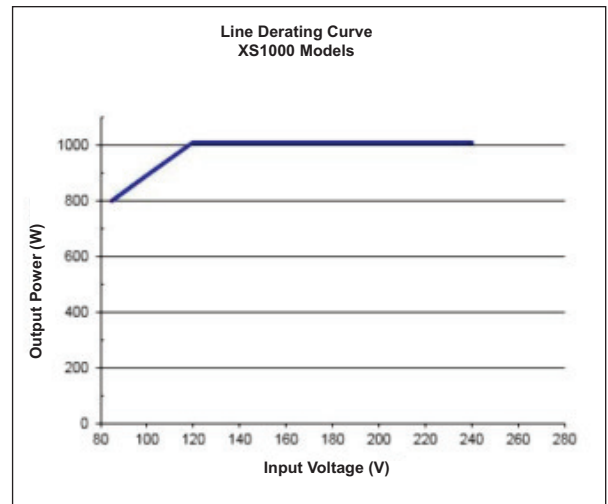
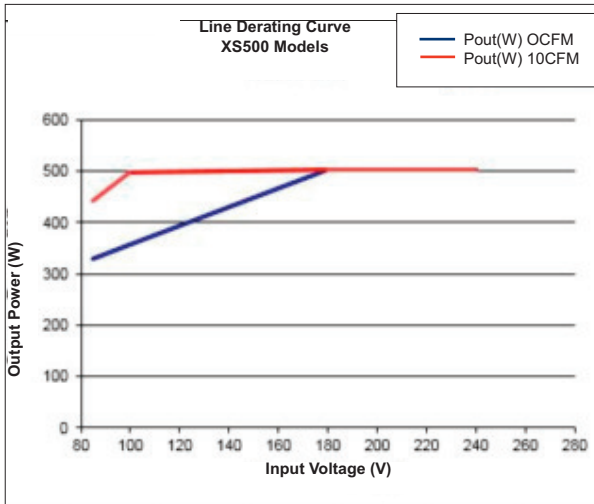

## Section 5.3

### Xsolo Connectors

#### Input Connector J7

Connector, Barrier Terminal Block, Vertical, 3 position, Pitch:0.375in  
Molex - 38720-7503

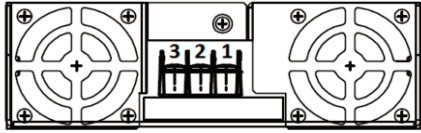

#### O/P Connector J10 and J12

Connector, Barrier STRIP DL 3CIRC .325 Tyco - 2-1437667-5  
*\*Note maximum current per screw terminal is 20Amps*

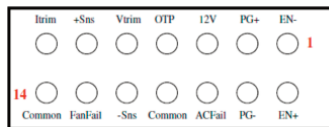
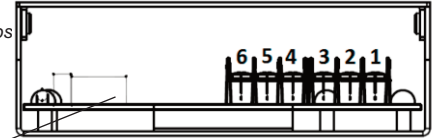

#### Output Signal Connector J5

Connector, Header 14POS 2MM Pitch T/H  
Molex - 87831-1420

#### J5 Mating Connectors

Locking Molex 51110-1451; Non Locking 51110-1450;  
Crimp Terminal: Molex p/n 50394

#### I<sup>2</sup>C Interface (Option)

The I<sup>2</sup>C PM Bus compatible interface can be used for monitoring the output voltage and current. It can also be used to manage real time data for the PSU.  
For full details on PM Bus please contact sales@excelsys.com.

#### PMBus Connector:

PL1: Molex - 87833-0831

#### PL1 Mating Connector:

Locking Molex 51110-0860; Non Locking 51110-0850; Crimp Terminal: Molex p/n 50394

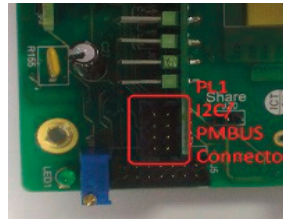

#### Connector Details

Pin	Input	Output	Signal	PMBus Connector
1	L	+Vo	EN-	Not Used
2	N	+Vo	EN+	SDA
3	PE	+Vo	PG+	SCL
4		-Vo	PG-	Not Used
5		-Vo	12V	Not Used
6		-Vo	ACFail	Not Used
7			OTP	Not Used
8			Common	GND
9			Vtrim	
10			-Sns	
11			+Sns	
12			FanFail	
13			Itrim	
14			Common	

#### AC Fail Signal

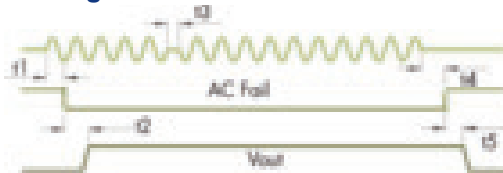

$$80\text{ms} < t1 < 700\text{ms}$$

$$10\text{ms} < t2 < 100\text{ms}$$

$$t3 = 10\text{ms}$$

$$t4 > 15\text{ms}$$

$$t5 > 2\text{ms}$$

#### AC Fail

AC Mains Fail signal is implemented by an open collector of an opto-isolator with a maximum sink current of 4mA. During normal operation the transistor is ON. When the input voltage is lost or goes below 80VAC, the opto-transistor is turned OFF at least 10mS before loss of output regulation (at nominal voltage or below).

#### Temperature Alarm

Open collector signal indicating that excessive temperature has been reached due to fan failure or operation beyond ratings. This signal is activated at least 10mS prior to system shutdown.

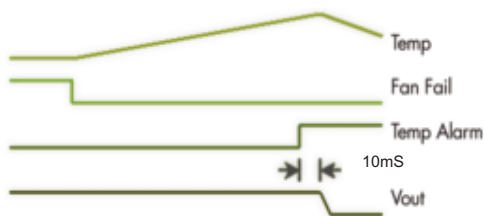

#### Fan Fail

Open collector signal indicating that at least one of the fans has failed. This does not cause power supply shutdown. The power supply will continue to operate until 10ms after the temperature alarm signal is generated.

\*Fan Fail, Temperature Fail and AC Fail signal figures above assume use of a pull up resistor to a signal voltage

#### Paralleling Xsolo's

To achieve increased currents Xsolo products can be paralleled. To connect in parallel the outputs must be trimmed to within 5mV of each other and then the current share header J20 must be added to each Xsolo product.

**Recommended Jumper for J20:** HARWIN M7567-05  
(Jumper Socket, Black, 2.54mm, 2-way)

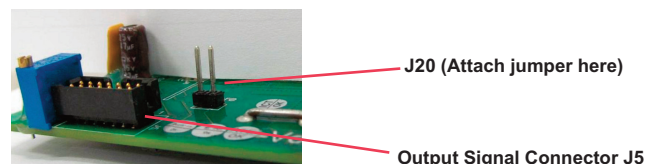



## Section 5.4 Xsolo Mechanical Drawings

All 3D/CAD Models available for download : <http://www.excelsys.com/technical-support/3d-files-and-cad-drawings/>

**XS500 Mechanical Specifications**  
(All dimensions in mm)

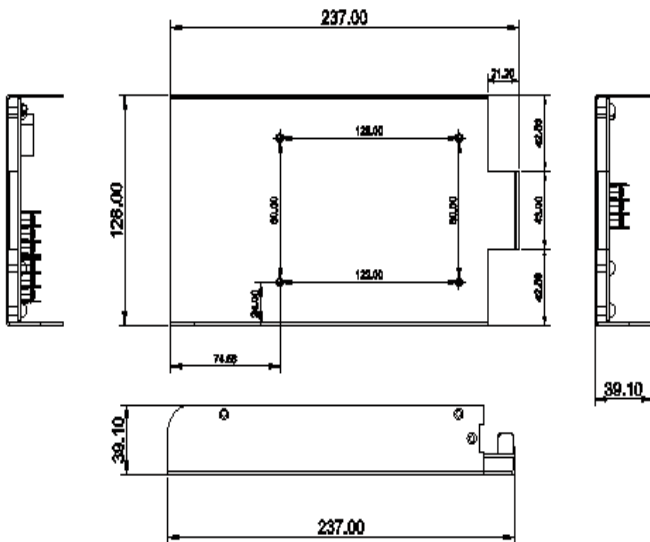
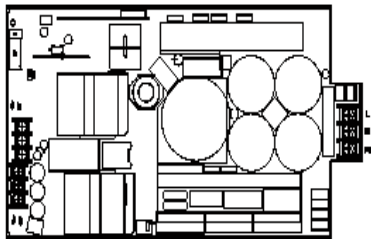

**XS1000 Mechanical Specifications**  
(All dimensions in mm)

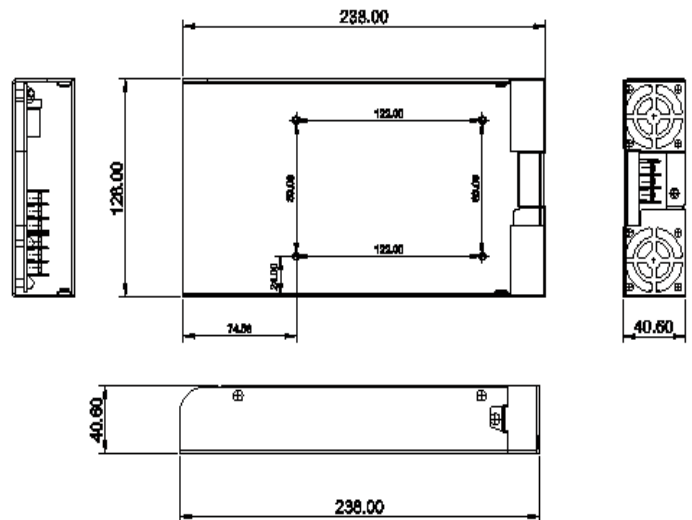
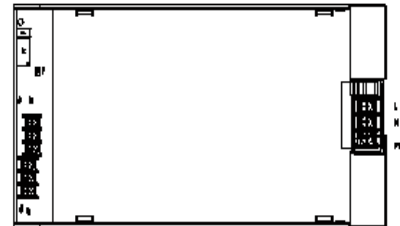

**Mounting Holes**  
4 M3 threaded PEMS on Base. Max Screw Penetration is 6mm from Base

**Mounting Holes**  
4 M3 threaded PEMS on Base. Max Screw Penetration is 6mm from Base

**NOTES**

- Note 1. SEMI F47 compliant at input voltages >160VAC. Consult Excelsys for details.
- Note 2. Consult Excelsys for HALT report (enhanced ruggedisation available as an option).
- Note 3. System design with low leakage capacitors requires particular attention to EMI. Please consult Excelsys for application details.
- Note 4. Contact sales@excelsys.com for details including MOQs on alternative preset output voltages.
- Note 5. The specifications contained herein are believed to be correct at time of publication and are subject to change without notice.
- Note 6. All specifications at nominal input, full load, 25°C unless otherwise stated.
- Note 7. Compliance with MIL-STD-461 (CE101 & CE102) achieved with the addition of an external line filter from LCR p/n F19374.
- Note 8. Product is not UL/EN certified for 120-380VDC input operation. Consult Excelsys for details.
- Note 9. Above 2000m altitude, ambient operating temperature decreases by 1 °C per 305m (1000 ft) altitude increase

## Section 5.5

### Configuring your Xsolo

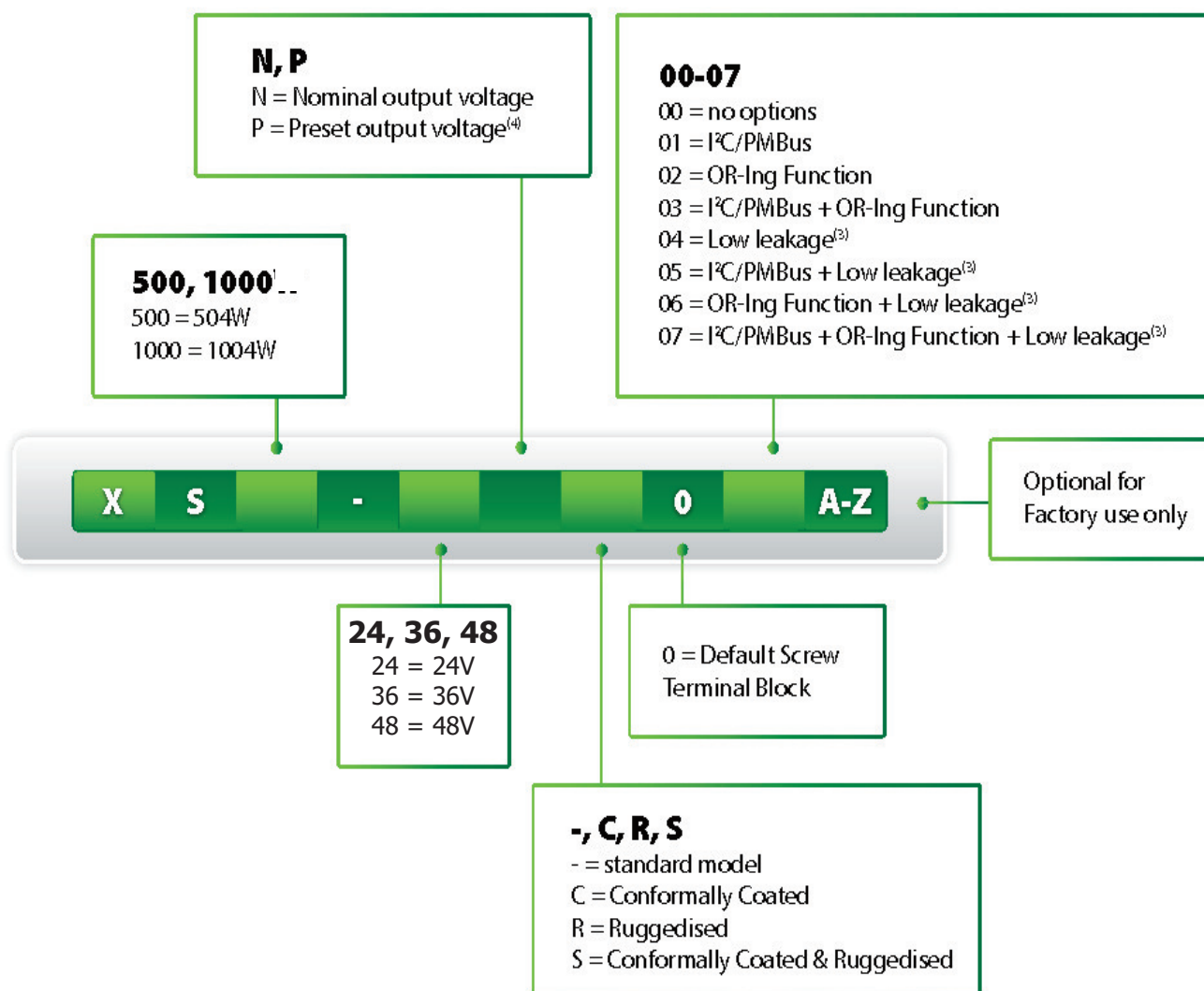

Example 1: XS1000-24N-000 = Xsolo 1000W, 24V output with no options

Example 2: XS1000-24N-003 = Xsolo 1000W, 24V output with I<sup>2</sup>C/PMBus and OR-Ing function.



Ultra-high efficiency 1U size



## Section 6.1 Overview of Xsolo

The Xsolo family of single output power supplies provides up to an incredible 1008W in an extremely compact package. Available in two package types, the high efficiency Xsolo delivers an incredible convection cooled 504W in an open-frame U-channel form factor and up to 1008W in an enclosed, fan cooled chassis.

The Xsolo platform comes with a host of features including: variable speed fan, 12V/300mA isolated bias supply, remote ON/OFF, output voltage control and parallel operation for higher power applications. Nominal output voltages are 24V, 36V and 48V with wide adjustment ranges and user defined set-points. Xsolo carries dual safety certification, EN60950 2nd Edition for Industrial Applications and EN60601-1 2nd and 3rd Edition for Medical Applications, meeting the stringent creepage and clearance requirements, 4KVAC isolation and <300uA leakage current. Xsolo is designed to meet MIL810G and is also compliant with SEMI F47 for voltage dips and interruptions as well as being compliant with all relevant EMC emission and immunity standards.

Optional features include I2C digital communications and OR-ing Function for N+1 redundancy. The product can also be conformal coated and ruggedised for use in harsh environments. With convection cooled power capability of over 500W, the Xsolo is ideal for use in a wide range of applications: industrial, Hi-Rel MIL-COTS applications, as well as acoustically sensitive laboratory and medical environments.

## Section 6.2 Xsolo Features

- EN60950 2nd Edition & EN60601-1 2nd and 3rd Edition
- MIL810G
- 2 MOPP
- SEMI F47 Compliant
- Ultra high efficiency, >92%
- Low profile: 1U height (40mm)
- Convection Cooled 500W/Fan Cooled 1000W (variable speed fan)
- 12V/300mA bias standby voltage provided
- Remote ON/OFF Signal, Power Good Signal
- 5 Year Warranty
- Type B & BF
- Adjustable output voltage
- 5000m altitude for EN60950 applications
- Product Options: Conformal Coating, Low Leakage Current, Ruggedised, PMBus, & OR-ing function

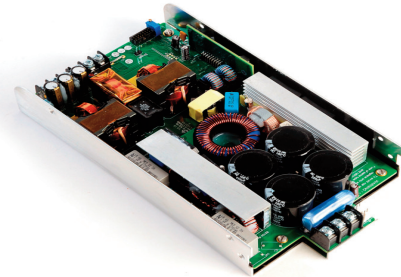

## APPLICATIONS INCLUDE

- Industrial
- Test & Measurement
- Medical
- Hi-Rel/MIL-COTS
- Communication



## Section 6.3

### Installation Considerations

The Xsolo models may be mounted on any of three surfaces using standard M3 screws. The chassis comes with four mounting points on the base. Maximum allowable torque is 2Nm. The maximum penetration depth is 6mm. Maintain a 50mm minimum clearance at both ends of the Xsolo power supply and route all cables so airflow is not obstructed. The XS1000 unit draws air in on the input side and exhausts air out the load side. If airflow ducting is used, avoid sharp turns that could create back pressure. XS500 units are convection cooled. See Excelsys Application Note: AN1504 on website.

Avoid excessive bending of output power cables after they are connected to the Xsolo *powerMods*. For high current outputs, use cable-ties to support heavy cables and minimise mechanical stress on output studs. Be careful not to short-out to neighbouring output studs.

The maximum torque recommended on output connectors is 3Nm. Avoid applications in which the unit is exposed to excessive shock or vibration that exceed the specified levels. In such applications, a shock absorption mounting design is required.

## Section 6.4

### Xsolo Control and Signals (Analog)

#### Voltage Adjustment

The Xsolo has been designed with maximum user flexibility as a key objective. The output voltage can be adjusted over a wide range by a number of methods.

Voltage adjustment and setting may be achieved by:

1. Voltage Setting via the on board potentiometer.
2. Remote voltage programming by applying a control voltage (Vcontrol) between J5 Pin 9 (Vtrim) and J5 Pin 10 (-Sense)
3. Remote voltage programming by applying a resistor between J5 Pin 9 (Vtrim) and J5 Pin 10 (-Sense).

An Excel spreadsheet has been developed to help users calculate output voltage and control values. These are available to download from the support section of our website; <http://www.excelsys.com/technical-support/>

#### XS500-24 and XS1000-24

By applying a control voltage (Vcontrol) between J5 Pin 9 (Vtrim) and J5 Pin 10 (-Sense) the output voltage of XS1000-24 and XS500-24 may be adjusted over a wide range. Vcontrol can be read from the graph below or calculated with the formula:

$$V_{\text{output}} = 12.59 \times V_{\text{control}}$$

**Important:** Vcontrol must not exceed 2.5V

Example.

Setting the output voltage to 20VDC via the Vtrim Pin

$$V_{\text{output}}/12.59 = V_{\text{control}}$$

$$20V/12.59 = 1.59V.$$

$$V_{\text{control}} = 1.59V$$

See Graph for full range.

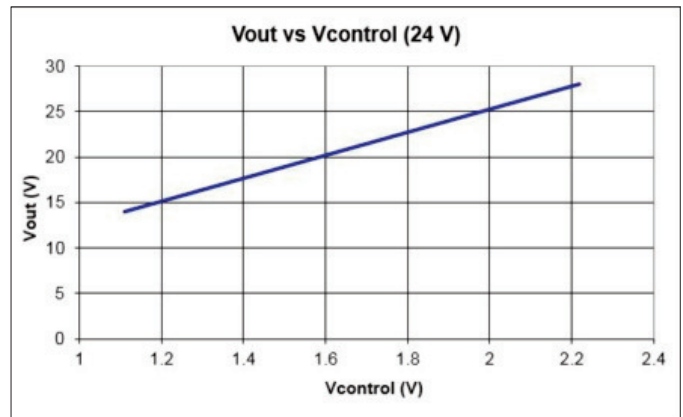

#### XS500-48 and XS1000-48

Using an external Voltage source (Vcontrol), the output voltage of the XS1000-48 and XS500-48 may be adjusted over a wide range.

By applying a control voltage (Vcontrol) between J5 Pin 9 (Vtrim) and J5 Pin 10 (-Sense) the output voltage of XS1000-48 and XS500-48 may be adjusted over a wide range. Vcontrol can be read from the graph below or calculated with the formula

$$V_{\text{output}} = 24.75 \times V_{\text{control}}$$

**Important:** Vcontrol must not exceed 2.5V

Example.

Setting the output voltage to 40VDC via the Vtrim Pin

$$V_{\text{output}}/24.75 = V_{\text{control}}$$

$$40V/24.75 = 1.62V.$$

$$V_{\text{control}} = 1.62V$$

See Graph below for full range.

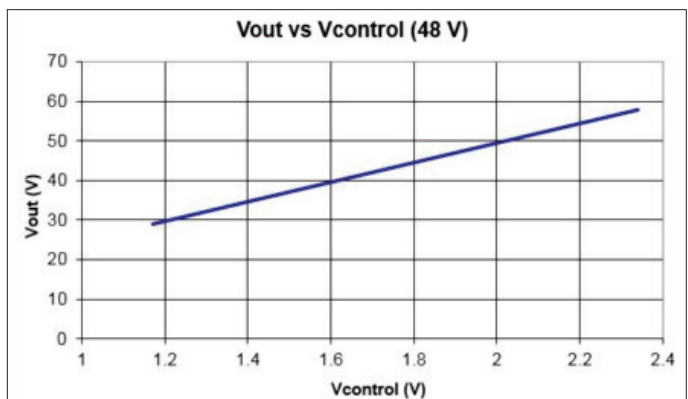

Remote voltage programming by an external resistor/potentiometer can also be implemented on the Xsolo. Simply apply the appropriate resistor value between J5 Pin 9 (Vtrim) and J5 Pin 10 (-Sense). An Excel spreadsheet has been developed to help users calculate output voltage and resistor values. These are available to download from the support section of our website; <http://www.excelsys.com/technical-support/>

#### Current Limit Adjustment ( Voltage)

The Xsolo has been designed to allow users to adjust the onset of Current Limit. By applying a voltage (Vcontrol) between the Itrim pin, (J5 Pin 13), and -Vout, current limit of the XS500-24 and XS1000-24 can be adjusted from 0A to the max current limit rating.

An Excel spreadsheet has been developed to help users calculate output current and control voltage values. These are available to download from the support section of our website; <http://www.excelsys.com/technical-support/>

**Current Limit Adjustment on XS500-24**

By applying a control voltage ( $V_{control}$ ) between Itrim (J5, Pin 13) and -Vout, current limit can be adjusted from 0-21A.  $V_{control}$  can be read from the graph below or calculated with the formula

$$I_{output} = 15.27 \times V_{control}$$

**Important:**  $V_{control}$  should not exceed 1.5V for XS500-24

Example.

Setting the output current limit of the XS500-24 to 15A via the Itrim Pin

$$I_{output}/15.267 = V_{control}$$

$$15A/15.267 = 0.98V$$

$$V_{control} = 0.98VDC$$

**Current Limit Adjustment on XS1000-24**

By applying a control voltage ( $V_{control}$ ) between Itrim (J5, Pin 13) and -Vout, current limit can be adjusted from 0-42A.  $V_{control}$  can be read from the graph below or calculated with the formula  $I_{output} = 15.267 \times V_{control}$

**Important:**  $V_{control}$  should not exceed 3.0V for XS1000-24

Example.

Setting the output current limit of the XS1000-24 to 30A via the Itrim Pin

$$I_{output}/15.267 = V_{control}$$

$$30A/15.267 = 1.96VDC$$

$$V_{control} = 1.96VDC$$

See Graph for full range.

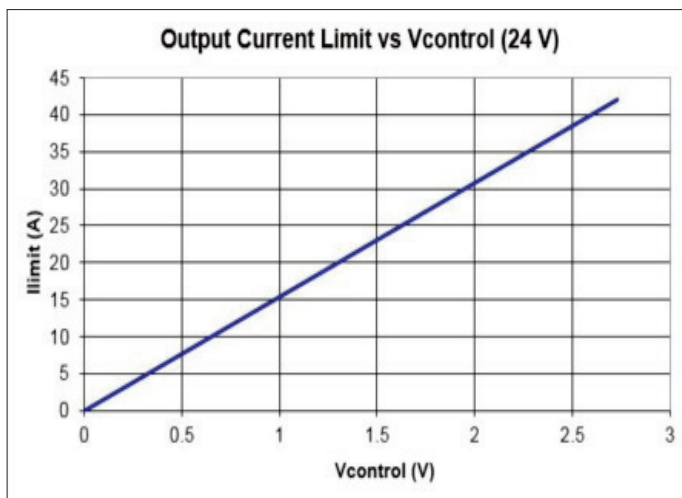
**Current Limit Adjustment on XS500-48**

By applying a control voltage ( $V_{control}$ ) between Itrim (J5, Pin 13) and -Vout, current limit can be adjusted from 0-10.5A.  $V_{control}$  can be read from the graph below or calculated with the formula

$$I_{output} = 8.06 \times V_{control}$$

**Important:**  $V_{control}$  should not exceed 1.5V for XS500-48

Example.

Setting the output current limit of the XS500-48 to 7.5A via the Itrim Pin

$$I_{output}/8.06 = V_{control}$$

$$7.5A/8.06 = 0.93V$$

$$V_{control} = 0.93VDC$$

**Current Limit Adjustment on XS1000-48**

By applying a control voltage ( $V_{control}$ ) between Itrim (J5, Pin 13) and -Vout, current limit can be adjusted from 0-21A.  $V_{control}$  can be read from the graph below or calculated with the formula

$$I_{output} = 8.06 \times V_{control}$$

**Important:**  $V_{control}$  should not exceed 3.0V for XS1000-48

Example.

Setting the output current limit of the XS1000-48 to 15A via the Itrim Pin

$$I_{output}/8.06 = V_{control}$$

$$15A/8.06 = 1.86VDC$$

$$V_{control} = 1.86VDC$$

See Graph for full range.

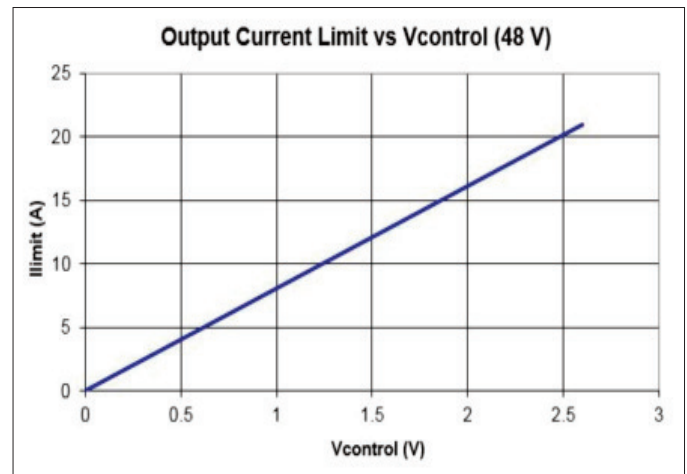
**Current Limit Adjustment via Resistor/Potentiometer**

The Xsolo has been designed to allow users to adjust the onset of Current Limit by applying a resistor between the Itrim pin, (J5 Pin 13), and -Vout. An Excel spreadsheet has been developed to help users calculate the appropriate resistor values to set output current. These are available to download from the support section of our website;

<http://www.excelsys.com/technical-support/>

**Current Limit Programming (Foldback)**

The Current Limit characteristics of the Xsolo can be programmed to be either Straight Line or Foldback. The previous sections refer to setting the Straight Line Current Limit of the Xsolo. To implement Foldback Current Limit, an Excel spreadsheet has been developed to help users calculate the appropriate resistor values to define the onset and final current limit points of the foldback current curve. These are available to download from the support section of our website;

<http://www.excelsys.com/technical-support/>

**Remote ON/OFF**

The Xsolo may be inhibited by means of an appropriate signal applied to an opto-isolated input (diode of an opto-isolator) on pins J5 connector Pin 2 (positive) and Pin 1 (negative). The delay from Inhibit to output turning OFF is typically <1ms.

Maximum current source allowed is 6.5mA.

Maximum applied voltage allowed is 13V.

**Fan Fail**

Fan Fail is an Open collector signal indicating that at least one of the Xsolo fans has failed. This does not cause power supply shutdown. The power supply will continue to operate for 10ms after the temperature alarm signal is generated.

The Fan Fail signal is accessed via J5 connector Pin 12. There is an on-board series current limit resistor of 2k connecting Pin 12 to the collector of an NPN transistor opto-coupler output. The emitter is connected to J5 Pin 8 – or Pin 14 (Common). When a fan-fail condition is detected this transistor turns off.

Maximum current source allowed is 6.5mA.  
Maximum applied voltage allowed is 13V.

**AC Mains Fail**

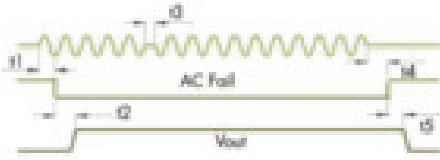

- 80ms < t1 < 600ms
- 10ms < t2 < 20ms
- t3 = 10ms
- t4 > 10ms
- t5 > 2ms

AC Mains fail signal is accessed through J5 connector Pin 6. There is an on-board series current limit resistor of 2kohm connecting Pin 6 to the collector of an NPN transistor opto-coupler output. The emitter is connected to J5 Pin 8 or Pin 14 (Common). During normal operation the transistor is ON. When input voltage is lost or goes below 80VAC the opto-transistor is turned OFF at least 2 ms before loss of output regulation. (The output voltage waveform above assumes a pull-up resistor to a maximum voltage of +13V)

Maximum current source allowed is 6.5mA.  
Maximum applied voltage allowed is 13V.

**Over-Temperature Protection (OTP)**

This is an opto-isolated open collector transistor signal indicating that excessive temperature has been reached due to fan failure or operation beyond ratings. This signal is activated at least 10ms prior to system shutdown. The OTP signal is accessed via J5 connector Pin 7. There is an on-board series connect limit resistor of 2Kohm connecting Pin 7 to the collector of an NPN transistor opto-coupler output. The emmitter is connected to J5 Pin 8 or Pin 14 (Common).

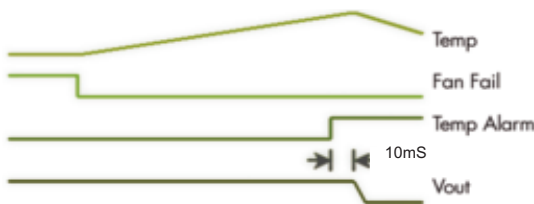

The Fan Fail and Temp Alarm signal waveforms in the diagram assume connection via a pull-up resistor to the 12 V bias source or an external voltage.

**Remote Sense**

Remote sensing can be used to compensate for voltage drops in the output loads.

Remote sensing may be implemented by connecting the Positive Sense pin (J5 pin 11) to the positive side of the remote load and the Negative Sense pin (J5 pin 10) to the negative side of the remote load. The maximum line drop, which can be compensated for by remote sensing, is 0.5V, subject to not exceeding the maximum module voltage at the output terminals.

**Power Good Signal**

The Xsolo contains an internal comparator which monitors the output voltage and determines whether this voltage is within normal operation limits. When the output voltage is within normal limits, the PowerGood signal is activated. The signal is implemented by an open collector of an opto-isolater which is available on J5 Pin 3 (collector) and J5 Pin 4 (emitter) (transistor ON = Power Good).

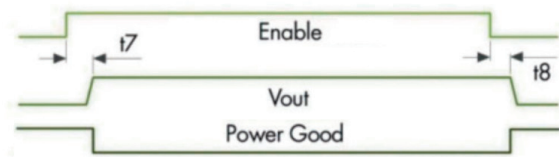

**Section 6.5**

**Parallel Connection and N+1 Redundant operation**

**How to Connect in Parallel**

To achieve increased current capacity, 2 or more Xsolo power supplies may be connected in parallel. To connect in parallel the current share header J20 must be added to each Xsolo product, all -Vo pins must be connected together and then the outputs must be trimmed to within 5mV of each other using the on-board potentiometer. Only then can the positive parallel connectors be attached, and the parallel supplies connected to the load.

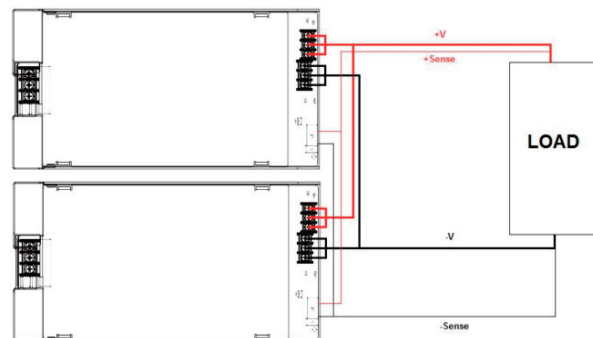

For optimal current sharing with OR-ing option a 10% min load is recommended. If paralleling 3 or more Xsolos consult Excelsys for applications support.

**Recommended Jumper for J20: HARWIN M7567-05**  
(Jumper Socket, Black, 2.54mm, 2-way)

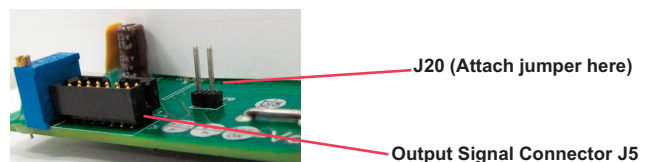

**How to implement N+1 Redundancy**

Xsolo can be utilised in systems that require N+1 redundant operation. The OR-ing option must be selected. Then simply connect the required number of Xsolo power supplies in parallel using the procedure for Parallel Connection of Xsolo.

## Section 6.6 Options

### Environmental Conformal Coating (Option C)

Xsolo is available with conformal coating for harsh environments and MIL-COTs applications. It is IP50 rated against dust and protected against vertical falling drops of water and non condensing moisture. Conformal coating material is polyurethane based and military qualified.

### Ruggedised Option (Option R)

Xsolo is available with extra ruggedisation for applications that are subject to extremes in shock and vibration. These parts have been tested on 3 axes, for a total of 300hours at 1.67g's rms.

### Conformally Coated and Ruggedised (Option S)

#### Features Options

- 00 = no options
- 01 = I2C/PMBus
- 02 = OR-ing Function
- 03 = 2C/PMBus + OR-ing Function
- 04 = Low Leakage
- 05 = I2C/PMBus + Low Leakage
- 06 = OR-ing Function + Low Leakage
- 07 = I2C/PMBus + OR-ing Function + Low Leakage

## Section 6.7 Xsolo Efficiency

The Xsolo series offer unrivalled efficiency with a maximum efficiency of over 92%. It is often the case that power supplies are operating at lower levels than their maximum ratings. Most power supplies have optimised efficiency at a higher load ratings (close to full rating) but perform significantly worse at light or lower loads.

The Xsolo design and component selection ensures that conversion losses are kept to a minimum over a wide range of output loads. For example, in the graph below, The XS1000 is still over 90% efficient at 30% of rated output (300W).



The XS500 is over 90% efficient at loads of 250W or higher.

The XS500 provides up to 504W with no fan cooling and is therefore a silent power supply. The XS1000 has a temperature controlled fan that only operates if and when the output load and internal component temperatures require.

Please refer to the Acoustic Noise vs Output Power XS1000 graph below. At loads below 500W the fan is not required and the XS1000 is silent.

The XS500 can also be cooled using system air flow. Please refer to XS500 derating curves get detailed line and temperature derating of the XS500.



## Section 6.8 Xsolo Acoustic Noise

The XS500 provides up to 504W with no fan cooling and is therefore a silent power supply. The XS1000 has an integral temperature controlled fan that only operates if and when the output load and internal component temperatures require. Please refer to the Acoustic Noise vs Output Power XS1000 graph below.

At loads below 500W the fan is not required and the XS1000 is silent.

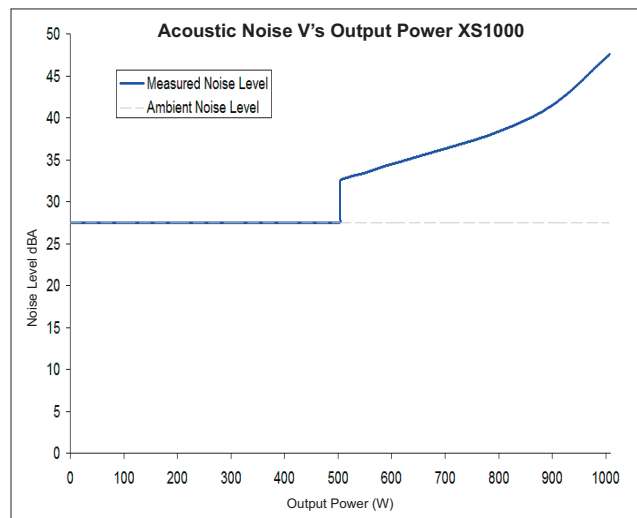

# Section 7 Reliability, Safety, EMI and Technical Resources

## Section 7.1

### Reliability

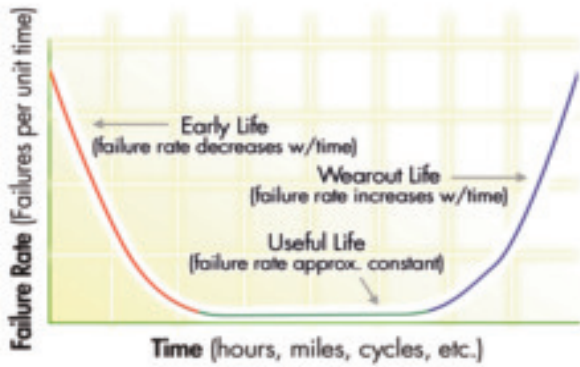

The 'bath-tub' curve shows how the failure rate of a power supply develops over time. It is made up of three separate stages. Immediately after production, some units fail due to defective components or production errors. To ensure that these early failures do not happen while in the possession of the user, Excelsys carries out a burn-in on each unit, designed to ensure that all these early failures are detected at Excelsys. After this period, the power supplies fail very rarely, and the failure rate during this period is fairly constant. The reciprocal of this failure rate is the MTBF (Mean Time Between Failures).

At some time, as the unit approaches its end of life, the first signs of wear appear and failures become more frequent. Generally 'lifetime' is defined as that time where the failure rate increases to five times the statistical rate from the flat portion of the curve.

In summary, the MTBF is a measurement of how many devices fail in a period of time (i.e. a measure of reliability), before signs of wear set in. On the other hand, the lifetime is the time after which the units fail due to wear appearing.

The MTBF may be calculated mathematically as follows:

$MTBF = \frac{\text{Total} \times t}{\text{Failure}}$ , where  
Total is the total number of power supplies operated simultaneously.  
Failure is the number of failures.  
t is the observation period.

MTBF may be established in two ways, by actual statistics on the hours of operation of a large population of units, or by calculation from a known standard such as Telecordia SR-332 and MIL-HDBK-217 and its revisions.

#### Determining MTBF by Calculation

MTBF, when calculated in accordance with Telecordia, MIL-HDBK-217 and other reliability tables involves the summation of the failure rates of each individual component at its operating temperature. The failure rate of each component is determined by multiplying a base failure rate for that component by its operating stress level.

The result is FPMH, the failure rate per million operating hours for that component.

Then FPMH for an assembly is simply the sum of the individual component FPMH.

$$\text{Total FPMH} = \text{FPMH}_1 + \text{FPMH}_2 + \dots + \text{FPMH}_n$$

$$\text{MTBF (hours)} = \frac{1,000,000}{\text{FPMH}}$$

In this manner, MTBF can be calculated at any temperature.

powerMod 0.958 failures per million hours  
4slot powerPac 0.92 failures per million hours  
6slot powerPac 0.946 failures per million hours

The figures for the powerPac excludes fans.

Example:

What is the MTBF of UX4DD00  
UX4 FPMH = 0.92  
XgD FPMH = 0.286  
Total FPMH = 1.49  
MTBF = 670,000 hours at 40°C

#### Xsolo MTBF

Xsolo has an MTBF of 550,000 hours at 40°C and full load based on the Telecordia SR-332 (fans excluded).

#### MTBF and Temperature

Reliability and MTBF are highly dependent on operating temperature. The figures above are given at 40°C. For each 10°C decrease, the MTBF increases by a factor of approximately 2. Conversely, however, for each 10°C increase, the MTBF reduces by a similar factor. Therefore, when comparing manufacturer's quoted MTBF figures, look at the temperature information provided. Contact Excelsys for detailed analysis of MTBF for your specific application conditions.

## Section 7.2

### Safety Approvals

UltiMod and Xsolo carry **dual safety certification, UL/EN60950 2nd Edition** for Industrial Applications and **UL/EN60601-1 2nd and 3rd Edition** for Medical Applications, meeting the stringent creepage and clearance requirements, 4KVAC isolation and <300uA leakage current. The Xgen series also carries full safety approvals. Refer to individual Xgen Datasheets for the relevant safety approvals carried by each model.

UltiMod, Xsolo and Xgen are designed to meet **MIL810G** and are also compliant with **SEMI F47** for voltage dips and interruptions as well as being compliant with all relevant EMC emission and immunity standards (Eee individual datasheets for details).

#### Safety Approvals

##### Low Voltage Directive (LVD) 2006/95/EC

The LVD applies to equipment with an AC input voltage of between 50V and 1000V or a DC input voltage between 75V and 1500V. The XSolo series is CE marked to show compliance with the LVD. The relevant European standard for UltiMod, Xsolo and Xgen models is EN60950 (Information technology). The 2nd Edition of this standard is now published and all relevant Excelsys power supplies are certified to the latest edition as well as the 1st Edition.

The relevant European standard for UltiMod, Xsolo and Xgen models is EN60601-1 (Medical Devices Directive). The 3rd Edition of this standard is published and all Excelsys medically approved power supplies are certified to this latest edition as well as the 2nd Edition. With appropriate packaging, the UltiMod, Xsolo and Xgen models can also meet the requirements of EN61010-1 for industrial scientific measuring equipment and process control.

UltiMod, Xsolo and Xgen models are certified to comply with the requirements of IEC950, EN60950, UL60950 (1st and 2nd Editions), and CSA 22.2 no. 234 and IEC1010, when correctly installed in a limited access environment.

The UltiMod, Xsolo and Xgen series are certified to comply with the requirements of IEC601-1, EN60601-1, UL60601-1 (2nd and 3rd Editions) and CSA601-1, for non-patient connect applications.



PowerMods are capable of providing hazardous energy levels (>240 VA). Equipment manufacturers must provide adequate protection to service personnel.

### Environmental Parameters

The UltiMod, Xsolo and Xgen series are designed for the following parameters

Material Group IIIb, Pollution Degree 2

Installation Category 2

Class I

Indoor use (installed, accessible to Service Engineers only).

Altitude: -155 metres to +3000 metres from sea level.

Humidity: 5 to 95% non-condensing.

Operating temperature -20°C to 70°C

Derate to 70°C. See *powerPac* Derating for details.

### Approval Limitations

#### Use in North America

When these products are used on 180 to 253 Volts AC mains with no neutral, connect the two live wires to L (live) and N (neutral) terminals on the input connector.

### Standard

Creepage Distances XL, XC, XK, XQ, XT, XB, XH models

Primary mains circuits to earth: 2.5mm spacing

Primary mains circuits to secondary: 5mm spacing

Dielectric strength XL, XC, XK, XQ, XT, XB, XH models

Primary mains circuits to chassis: 1500VAC

Primary mains circuits to secondary: 3000VAC

### Medical

Creepage Distances UltiMod, Xsolo, XM, XV, XR, XZ, XN, XW models

Primary mains circuits to earth: 4mm spacing

Primary mains circuits to secondary: 8mm spacing

Dielectric strength UltiMod, Xsolo, XM, XV, XR, XZ, XN, XW models

Primary mains circuits to chassis: 1500VAC

Primary mains circuits to secondary: 4000VAC

The primary to secondary test is not possible with modules fitted to the unit, as damage to the EMI capacitors will occur.

### Output Isolation

Xsolo : Output to Chassis isolation is 1500VAC.

UltiMod, Xgen: Output to Output Isolation is 500VDC  
Output to Chassis Isolation is 500VDC

## Section 7.3 EMC Characteristics

### EMC Directive 2004/108/EC

Component Power Supplies such as the UltiMod, Xsolo and Xgen series are not covered by the EMC directive. It is not possible for any power supply manufacturer to guarantee conformity of the final product to the EMC directive, since performance is critically dependent on the final system configuration. System compliance with the EMC directive is facilitated by Excelsys products compliance with several of the requirements as outlined in the following paragraphs. Although the UltiMod, Xsolo and Xgen series meet these requirements, the CE mark does not cover this area.

### EMISSIONS

#### Power Factor (Harmonic) Correction

The UltiMod, Xsolo and Xgen series incorporates active power factor correction and therefore meets the requirements of EN61000-3-2. Power factor: 0.98.

### EN61000-3-3 Flicker & Voltage Fluctuation Limits

UltiMod, Xsolo and Xgen power supplies meet the requirements of the limits on voltage fluctuations and flicker in low voltage supply systems.

### EN55022 Class B Conducted Emissions

For system compliance to EN55022, Level B, additional filtering may be required, for technical support, contact our Applications Engineering team.

### IMMUNITY

The UltiMod, Xsolo and Xgen series has been designed to meet, and tested to, the immunity specifications outlined below:

### EN61000-4-2 Electrostatic Discharge Immunity

8kV Air discharge applied to Enclosure

6kV Contact with Enclosure

### EN61000-4-3 Radiated Electromagnetic Field

10Volts/metre 80MHz to 2.5GHz applied to Enclosure

### EN61000-4-4 Fast Transients-Burst Immunity

+/-2kV

### EN61000-4-5 Input Surge Immunity

Xsolo:

+/-4kV Common Mode 1.2/50 S (Voltage); 8/20uS (Current)

+/-2kV Differential Mode 1.2/50 S (Voltage) 8/20 S (Current)

UltiMod and Xgen:

+/-2kV Common Mode 1.2/50 S (Voltage); 8/20uS (Current)

+/-1kV Differential Mode 1.2/50 S (Voltage) 8/20 S (Current)

### EN61000-4-6 Conducted Immunity

10 V/m 150KHz to 80MHz

### EN61000-4-11 Voltage Dips

0% 1s Criteria B

40% 100ms Criteria B

70% 10ms Criteria A

Further details on all tests are available from Excelsys.

### Guidelines for Optimum EMC Performance

All Excelsys products are designed to comply with European Normative limits (EN) for conducted and radiated emissions and Immunity, when correctly installed in a system. However, power supply compliance with these limits is not a guarantee of system compliance and system EMC performance can be impacted by a number of items.

Cabling arrangements and PCB tracking layouts are the greatest contributing factors to system EMC performance. All cables and PCB tracks should be treated as radiation sources and antenna. Every effort should be made to minimise current carrying loops that can radiate, and to minimise loops that could have noise currents induced into them.

- Keep all cable lengths as short as possible.
- Minimise the area of power carrying loops to minimise radiation, by using twisted pairs of power cables with the maximum twist possible.
- Run PCB power tracks back to back.
- Minimise noise current induced in signal carrying lines, by twisted pairs for sense cables with the maximum twist possible.
- Do not combine power and sense cables in the same harness
- Ensure good system grounding. System Earth should be a "starpoint". Input earth of the equipment should be directed to the "starpoint" as soon as possible. The power supply earth should be connected directly t

### EMI for XF

The XF series of Hi-Rel/MIL-COTS Modular power supplies have been designed for used in harsh environments including military applications. Please contact Excelsys for information relating to MIL461F, CE101 and CE102 EMI characterisation. Contact our applications team for support on external filter recommendations.

# TECHNICAL RESOURCES



## CONSULT AN ENGINEER

Our experienced applications engineering team is ready to provide design consultancy support including product recommendations to deliver optimal systems performance, and most importantly reduced time to market. We are committed to providing you with the highest performing, most reliable power solution ensuring the lowest total cost of ownership for you.

To contact one of our team please e-mail [support@excelsys.com](mailto:support@excelsys.com) or telephone:

**North America and Canada:** +1 972 771 4544

**Europe and Asia:** +353 21 4354716

## ONLINE RESOURCES



Our website [www.excelsys.com](http://www.excelsys.com) hosts a wide range of easily accessible resources to support your power supply decision making. This includes:

- **Application Notes:** Supporting system designers in the integration of the Excelsys power supplies into their system.
- **Safety and Environmental Certification:** All our power supplies carry full international safety agency approvals including UL and EN for information technology and medical power supplies. To ease the system safety approvals we have provided our UL and CB certificates and we have also included our declarations of conformity. All Excelsys power supplies are REACH and RoHS compliant. Visit our Safety and Environmental section online where you can download our UL and CB safety certifications, and declarations of conformity to simplify system compliance.
- **EMI Characterisation:** Excelsys power supplies are component power supplies and as such are not subject to the EMC directive for EMI, however in order to ease system integration, Excelsys Technologies has carried out extensive EMI characterization of our products against the relevant standards.
- **HALT (Highly Accelerated Life Testing):** Poor reliability, low MTBF, frequent field returns, high in-warranty costs and customer dissatisfaction are often the result of design and/or process weaknesses, even if a product has successfully

passed qualification tests and burn-in. Excelsys Technologies subjects all our products to the HALT (Highly Accelerated Life Testing) process to uncover design and/or process weaknesses. During the HALT process, the product is subjected to progressively higher stress levels brought on by thermal dwells, vibration, rapid temperature transitions and combined environments.

- **White Papers:** Excelsys team of experienced power supply designers have an extensive knowledge of power supplies, technology and the challenges facing system designers. In conjunction with the UltiMod, Xsolo and Xgen Designers' Manual, and Application Notes, we also prepare White Papers on topics that are relevant to system designers.
- **Designers' Manual:** Excelsys has created Designers' Manual for our UltiMod, Xsolo and Xgen series of power supplies. These have been prepared to assist engineers and technicians in understanding correct design practices necessary to achieve the maximum versatility and performance from any of the UltiMod products. Whatever your application, be it industrial electronics, medical equipment, automation equipment etc., these Designers' Manuals provide the system designer with easy to implement integration instructions. The various Designers' Manuals can be downloaded from the Excelsys website.
- **Datasheets:** All Excelsys product datasheets are available to download online.
- **3D files and CAD drawings:** 3D CAD files in a number of formats (STEP, DXF and DWG formats) are available to download from our website. These files can easily imported by system designers to simplify the mechanical engineering design of systems. Download 3D files & CAD drawings from <http://www.excelsys.com/technical-support/3d-files-and-cad-drawings/>.
- **Online Configurator:** Whatever your power supply needs, Excelsys has a solution for you. Design your power supply using our Online Configurator. Simply input your volts and amps, and the configurator will generate a power supply solution to meet your exact power requirement. Visit the Excelsys Online Configurator at [http://www.excelsys.com/xgen\\_configurator/configure.html](http://www.excelsys.com/xgen_configurator/configure.html)
- **Online Calculators:** Excelsys have developed a range of online calculators to assist system developers in utilising the wide feature set of our products. Voltage adjustment and control, Current limit adjustment and weight calculators are available online and to download. These are available to download <http://www.excelsys.com/technical-support/>

The specifications contained herein are believed to be correct at time of publication and are subject to change without notice.



Excelsys supports customers and distributors worldwide. With experienced Applications Teams based in the US and in Europe, this allows Excelsys to offer immediate support and service to our customers.

Whatever your application, our dedicated team is ready to assist you in defining and implementation of the optimum power supply solution. Check out our *"Contact Us"* page on our website [www.excelsys.com](http://www.excelsys.com) and speak with your local Excelsys distributor.

Excelsys Technologies Ltd.  
27 Eastgate Drive  
Eastgate Business Park  
Little Island  
Co. Cork  
Ireland

t: +353 21 4354716  
f: +353 21 4354864  
e: [sales@excelsys.com](mailto:sales@excelsys.com)

Excelsys Technologies  
80 Bricketts Mill Road,  
Hampstead,  
New Hampshire  
03841  
USA

t: +1 972 771 4544  
f: +1 972 421 1805  
e: [salesusa@excelsys.com](mailto:salesusa@excelsys.com)