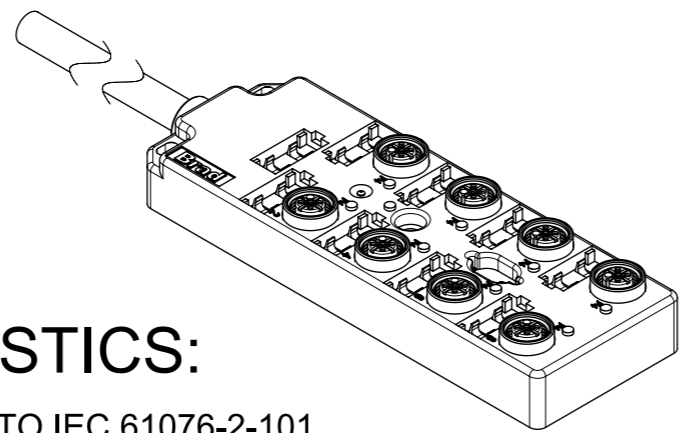
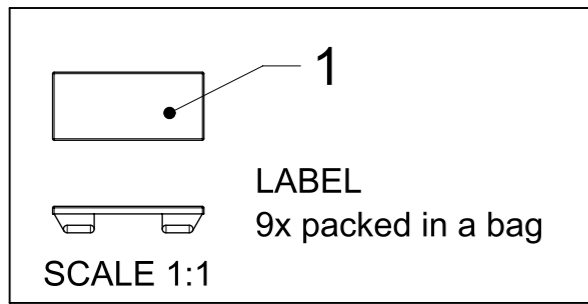
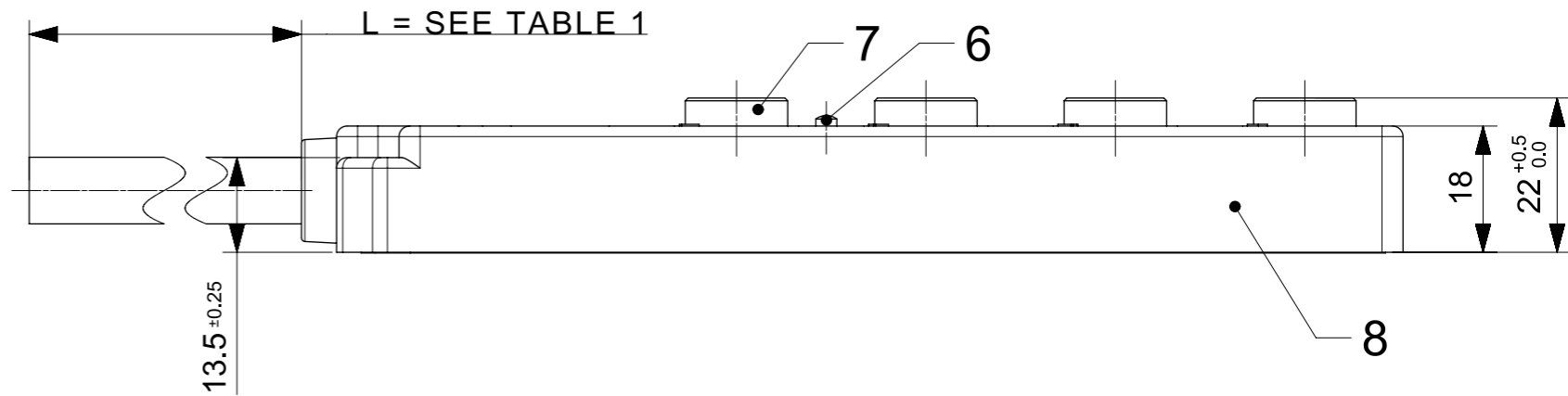
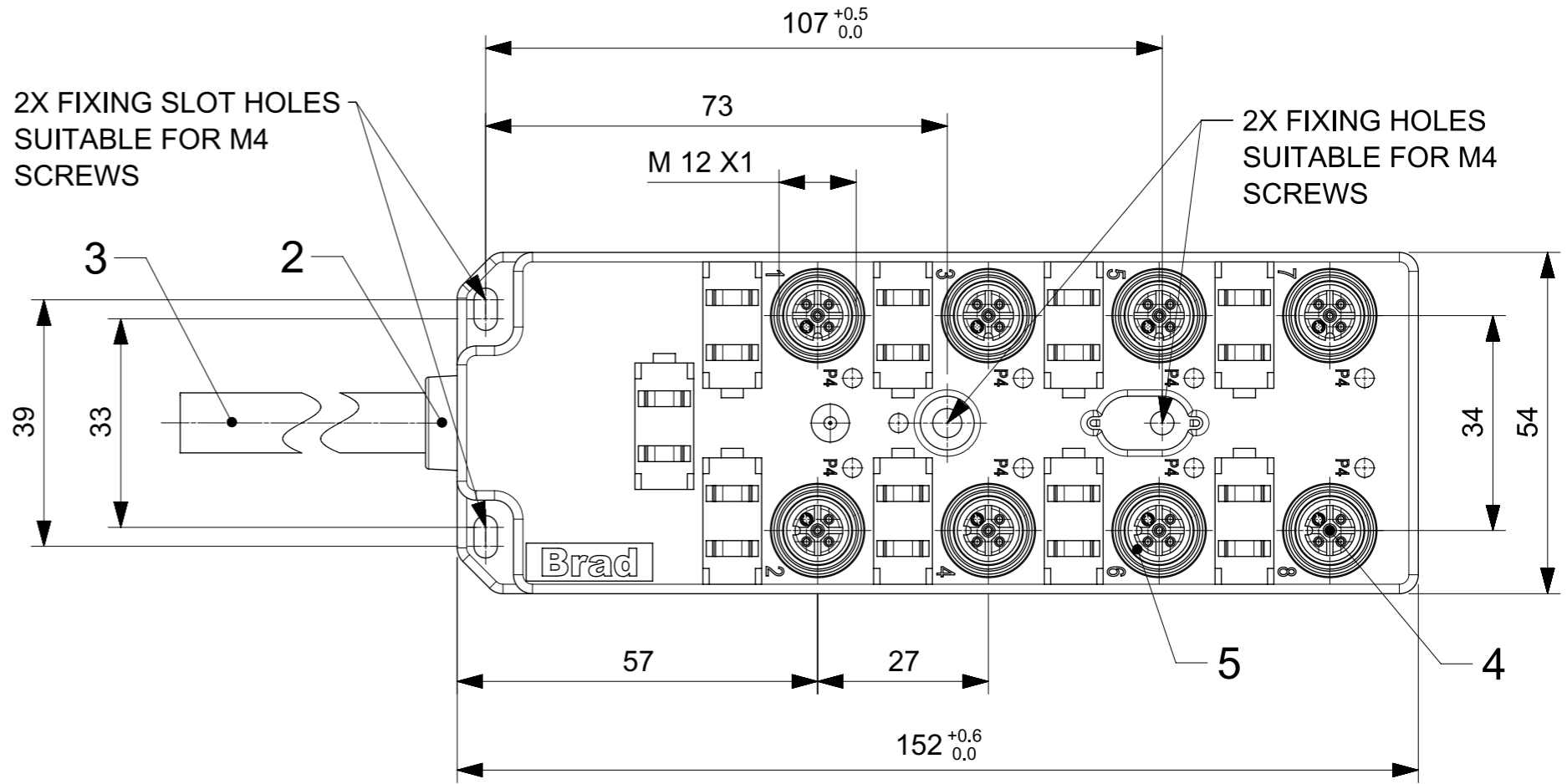

TABLE 1

MOLEX P/N	ENG. NO.	CABLE LENGTH (mm)	LED
1202480019	BTB8000-FBW-05	5000	NO
1202480020	BTB8000-FBW-10	10000	NO
1202480021	BTB8000-FBW-15	15000	NO
1202480022	BTB800P-FBW-05	5000	YES
1202480023	BTB800P-FBW-10	10000	YES
1202480024	BTB800P-FBW-15	15000	YES
1202480025	BTB400N-FBW-05	5000	YES
1202480026	BTB800N-FBW-10	10000	YES
1202480027	BTB800N-FBW-15	15000	YES

TABLE 2 BILL OF MATERIAL

ITEM	DESCRIPTION	MATERIAL	FINISH
1	LABEL	ABS	WHITE
2	CABLE PLATE	PBT	BLACK
3	CABLE	TPU BASED	BLACK
4	CONTACT	BRONZE	GOLD OVER NICKEL
5	O-RING	FPM	RED
6	LED	NO LED = PA	BLACK
		WITH LED = PA	TRANSPARENT
7	SHELL	BRASS	NICKEL PLATED
8	HOUSING	PBT	BLACK



GENERAL CHARACTERISTICS:

ELECTRICAL AND MECHANICAL DATA ACC. TO IEC 61076-2-101

NOMINAL VOLTAGE: 10-30 V DC
 AMPERE RATING: 4 A PER PORT / 12 A MAX
 AMPERE RATING WITH UL REGISTRATION: 3 A PER PORT / 9 A MAX
 IP DEGREE OF PROTECTION: IP 67
 TEMPERATURE RANGE: -25°C to + 85°C

THIS DRAWING CONTAINS INFORMATION THAT IS PROPRIETARY TO MOLEX INCORPORATED AND SHOULD NOT BE USED WITHOUT WRITTEN PERMISSION

EC DESCRIPTION EC NO: 100589 DRWN: AAHLERS CHK'D: APPR: RSILLER REV: A1	2015/06/09 2015/07/02	QUALITY SYMBOLS ∇ = 0 ∇ = 0 ∇ = 0 ▼ = 0 ∇ = 0 ⊠ = 0 ■ = 0 ∇ = 0	GENERAL TOLERANCES (UNLESS SPECIFIED) ANGULAR TOL ± ° 4 PLACES ± 3 PLACES ± 2 PLACES ± 1 PLACE ± 0 PLACES ± 0.25 DRAFT WHERE APPLICABLE MUST REMAIN WITHIN DIMENSIONS	DIMENSION UNITS: MM SCALE: 1:1 DRWN BY: AAHLERS DATE: 2015/04/01 CHK'D BY: DATE: APPR BY: RSILLER DATE: 2015/05/20 DRAWING SIZE: A3 THIRD ANGLE PROJECTION	molex MPIS M12 PNP NPN NOS 4P 8PT AC FE STR BK XM STA SINGLE PRODUCT CUSTOMER DRAWING SERIES: 120248 MATERIAL NUMBER: SEE TABLE 1 CUSTOMER: GENERAL MARKET DOCUMENT NUMBER: 1202480019 DOC TYPE: PSD DOC PART: 000 SHEET NUMBER: 1 OF 2			
--	--------------------------	---	--	---	--	--	--	--

Wiring Diagram NON LED Single

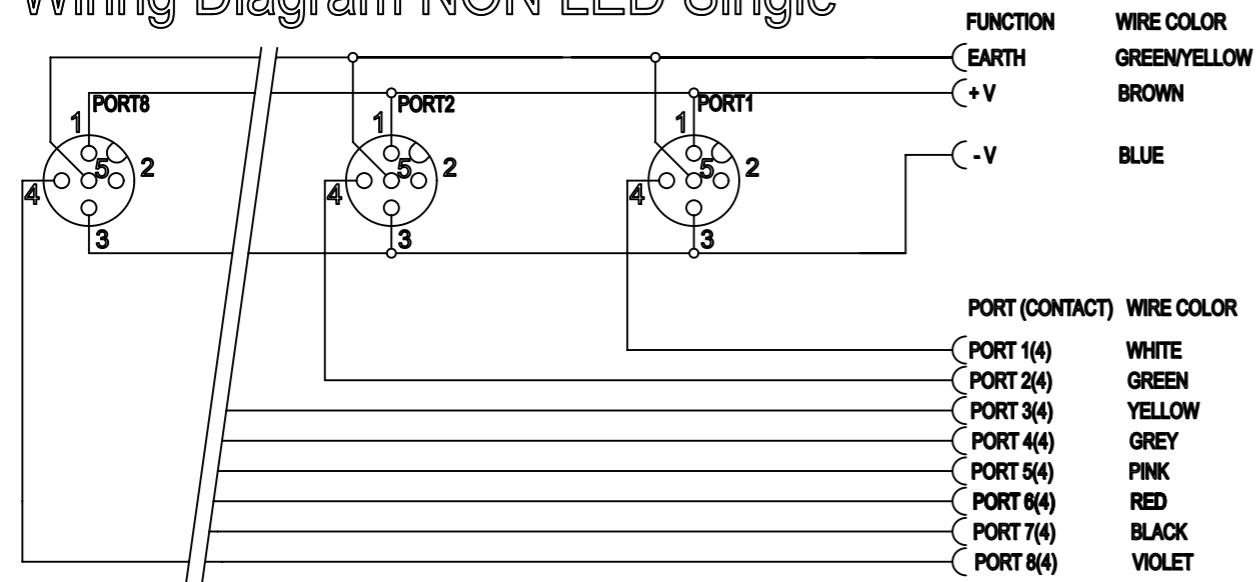

Wiring Diagram PNP Single

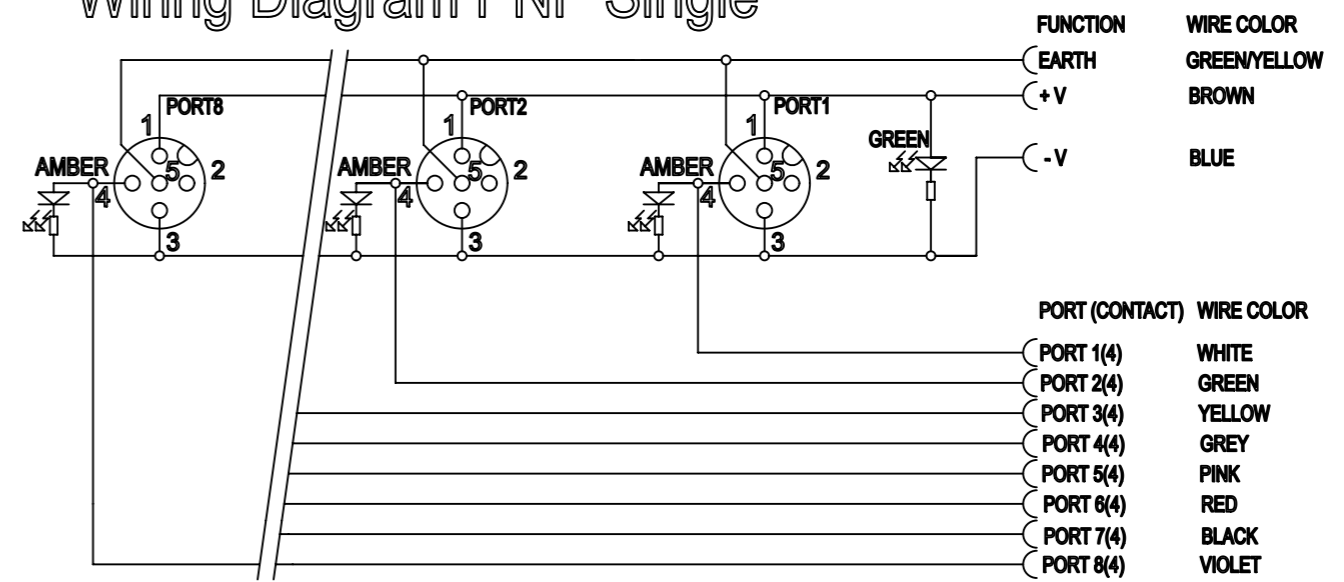

Wiring Diagram NPN Single

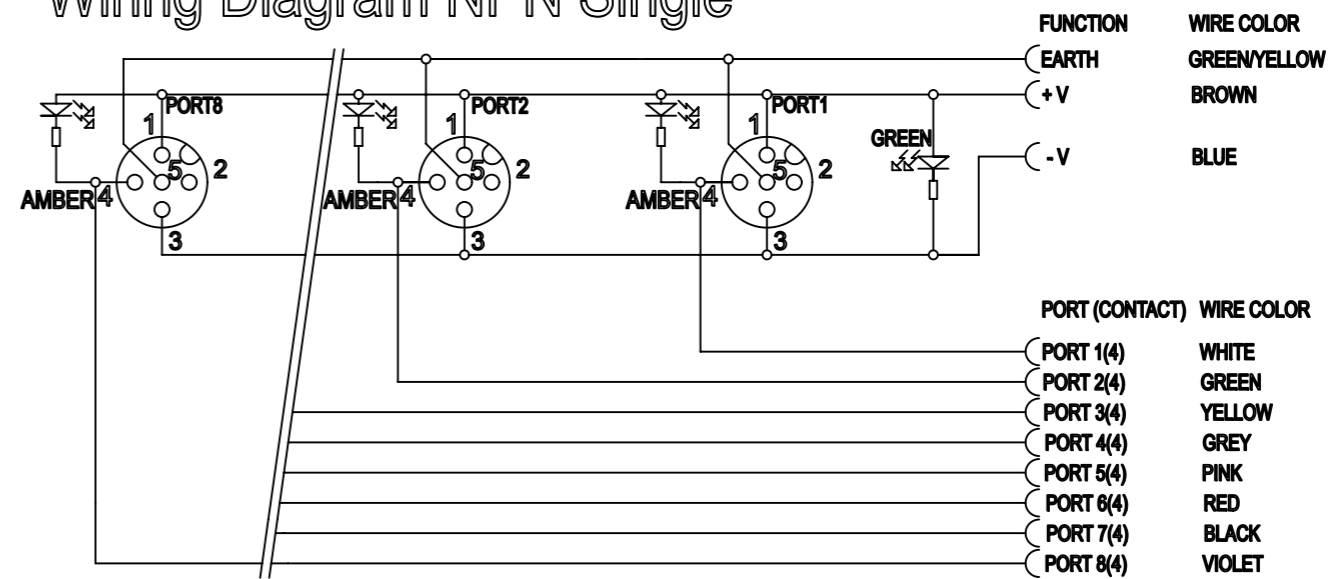

THIS DRAWING CONTAINS INFORMATION THAT IS PROPRIETARY TO MOLEX INCORPORATED AND SHOULD NOT BE USED WITHOUT WRITTEN PERMISSION

EC DESCRIPTION EC NO: 100589 DRWN: AAHLERS CHK'D: APPR: RSILLER	2015/06/09 2015/07/02	QUALITY SYMBOLS ▽ = 0 ▽ = 0 ▽ = 0 ▼ = 0 ▽ = 0 ⊠ = 0 ■ = 0 ▽ = 0	GENERAL TOLERANCES (UNLESS SPECIFIED)		DIMENSION UNITS MM	SCALE 1:1				
			ANGULAR TOL ± °		DRWN BY AAHLERS	DATE 2015/04/01				MPIS M12 PNP NPN NOS 4P 8PT AC FE STR BK XM STA SINGLE
			4 PLACES ±		CHK'D BY DATE	PRODUCT CUSTOMER DRAWING				
			3 PLACES ±		APPR BY RSILLER	DATE 2015/05/20	SERIES 120248	MATERIAL NUMBER SEE TABLE 1	CUSTOMER GENERAL MARKET	
2 PLACES ±		DRAFT WHERE APPLICABLE MUST REMAIN WITHIN DIMENSIONS		DRAWING SIZE A3	THIRD ANGLE PROJECTION		DOCUMENT NUMBER 1202480019	DOC TYPE PSD	DOC PART 000	SHEET NUMBER 2 OF 2
1 PLACE ±										
0 PLACES ± 0.25										