

LOC	DIST	REVISIONS					
E	B	P	LTR	DESCRIPTION	DATE	DWN	APVD
			BA	NEW RELEASE	07-OCT-09	MRS	St.P

FOR FURTHER INFORMATION SEE DATA SHEET FOR
CRG SERIES-THICK FILM CHIP RESISTORS

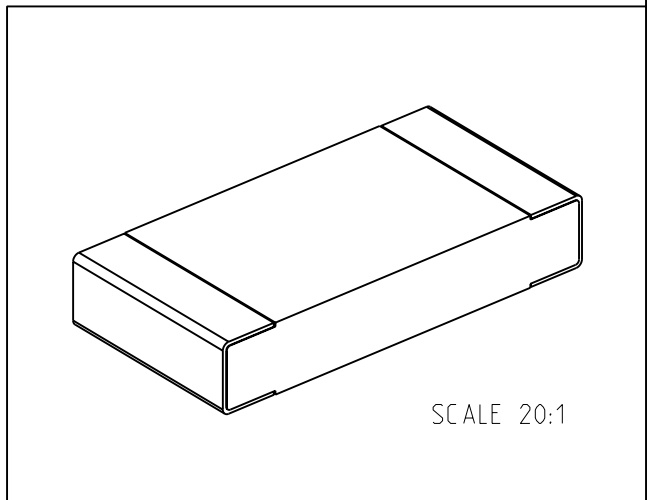

RoHS Compliant



SCALE 20:1

2009

RELEASED FOR PUBLICATION

THIS DRAWING IS UNPUBLISHED.

© COPYRIGHT 2009 BY TYCO ELECTRONICS CORPORATION. ALL RIGHTS RESERVED.

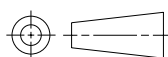
DIMENSIONS: mm	DWN MAHARUDRA	07-OCT-09	MATERIAL	-	FINISH	-
	CHK ALLAN.P	07-OCT-09	 Tyco Electronics Corporation Dorcan, Swindon, SN3 5HH			
TOLERANCES UNLESS OTHERWISE SPECIFIED:	APVD STEPHEN.P	07-OCT-09				
0 PLC ±0.5	PRODUCT SPEC	-	NAME THICK FILM CHIP RESISTORS SERIES CRG 1206			
1 PLC ±0.2	APPLICATION SPEC	-				
2 PLC ±0.1	WEIGHT	-	SIZE	CAGE CODE	DRAWING NO	RESTRICTED TO
3 PLC ±-			A 4	00779	© = 1623406	-
4 PLC ±-			CUSTOMER DRAWING			
ANGLES ±5°			SCALE	30:1	SHEET	1 OF 1
			REV BA			