

## LOW NOISE AMPLIFIER MODULE, 5 - 9 GHz

### Features

- Low Noise Figure: 1.75 dB @ 6 GHz
- High Gain: 22 dB
- Output IP3: +25 dBm
- P1dB Output Power: +14.8 dBm
- 50 Ohm Matched & DC Blocked RF I/Os
- Hermetically Sealed Module
- Field Replaceable SMA Connectors
- 55 °C to +85 °C Operating Temperature

### Typical Applications

The HMC-C048 LNA is ideal for:

- Telecom Infrastructure
- Microwave Radio & VSAT
- Military & Space
- Test Instrumentation

### Functional Diagram

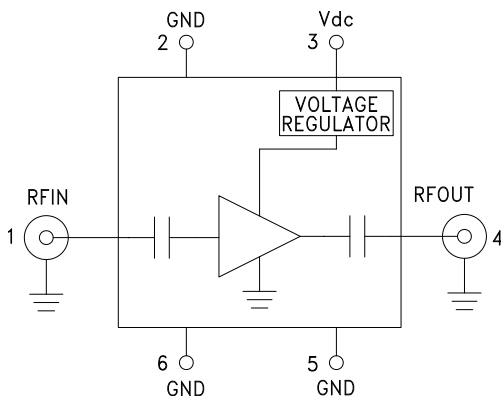

### General Description

The HMC-C048 is a GaAs MMIC pHEMT Low Noise Amplifier in a miniature, hermetic module which operates between 5 and 9 GHz. This high dynamic range low noise amplifier module provides 22 dB of gain and up to +25 dBm of output IP3 while operating from a single positive supply between +8V and +16V. The amplifier I/Os are internally matched to 50 Ohms and DC blocked for robust performance. The module features removable coaxial connectors which can be detached to allow direct connection of the I/O pins to a microstrip or coplanar circuit.

### Electrical Specifications, $T_A = +25^\circ\text{C}$ , $V_{dc} = +12\text{V}$

Parameter	Min.	Typ.	Max.	Units
Frequency Range		5 - 9		GHz
Gain	18.5	22.5		dB
Gain Variation Over Temperature		0.015		dB/ °C
Noise Figure		1.75	2.3	dB
Input Return Loss		14		dB
Output Return Loss		15		dB
Output Power for 1 dB Compression (P1dB)	12	14.8		dBm
Saturated Output Power (Psat)		16.7		dBm
Output Third Order Intercept (IP3)		25		dBm
Supply Current		105	140	mA

# HMC-C048\* PRODUCT PAGE QUICK LINKS

Last Content Update: 02/23/2017

---

## COMPARABLE PARTS

View a parametric search of comparable parts.

## DOCUMENTATION

### Application Notes

- AN-1363: Meeting Biasing Requirements of Externally Biased RF/Microwave Amplifiers with Active Bias Controllers

### Data Sheet

- HMC-C048 Data Sheet

## TOOLS AND SIMULATIONS

- HMC-C048 S-Parameter

## DESIGN RESOURCES

- HMC-C048 Material Declaration
- PCN-PDN Information
- Quality And Reliability
- Symbols and Footprints

## DISCUSSIONS

View all HMC-C048 EngineerZone Discussions.

## SAMPLE AND BUY

Visit the product page to see pricing options.

## TECHNICAL SUPPORT

Submit a technical question or find your regional support number.

## DOCUMENT FEEDBACK

Submit feedback for this data sheet.

---



**LOW NOISE AMPLIFIER  
MODULE, 5 - 9 GHz**

**Broadband Gain & Return Loss**

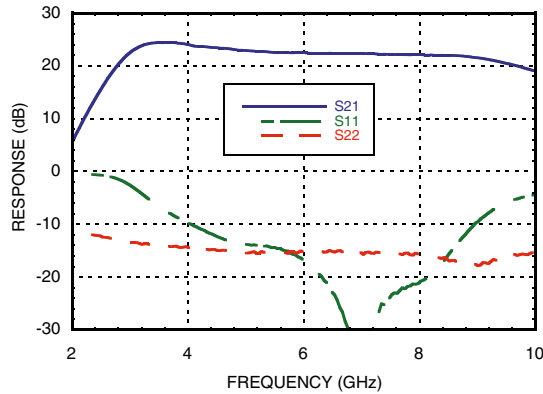

**Gain vs. Temperature**

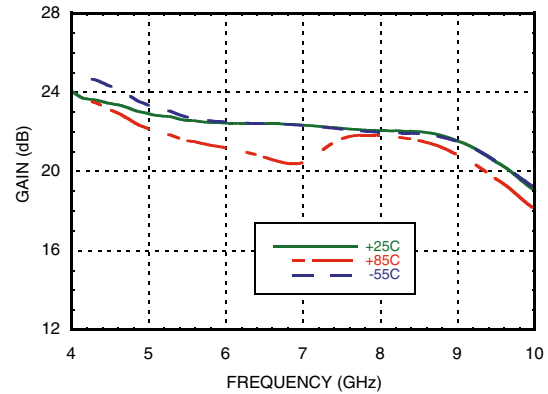

**Input Return Loss vs. Temperature**

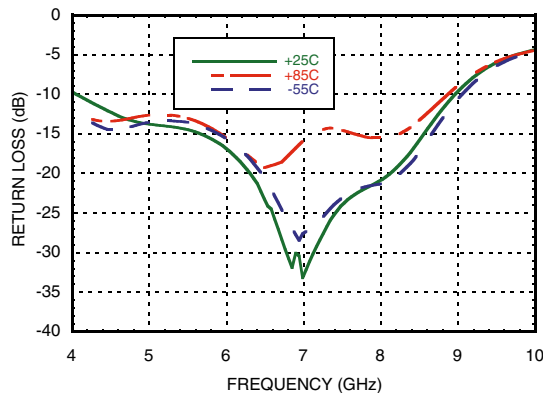

**Output Return Loss vs. Temperature**

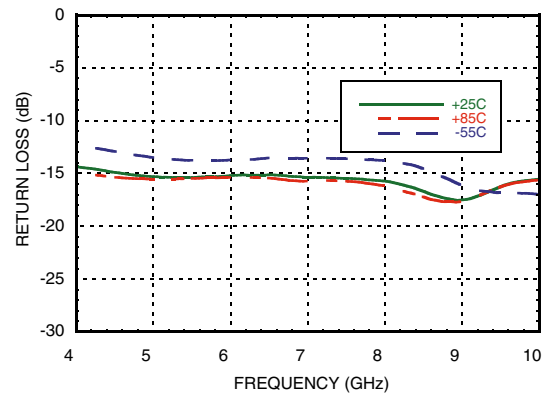

**Reverse Isolation vs. Temperature**

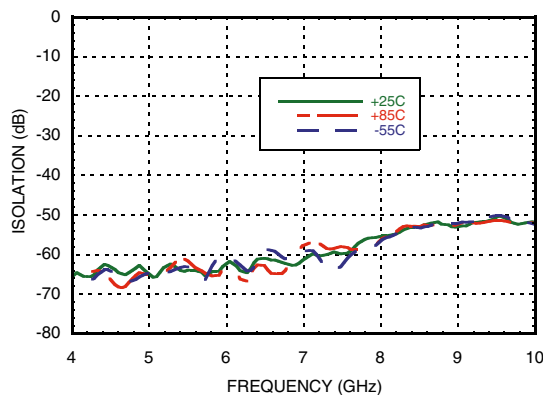

**Noise Figure vs. Temperature**

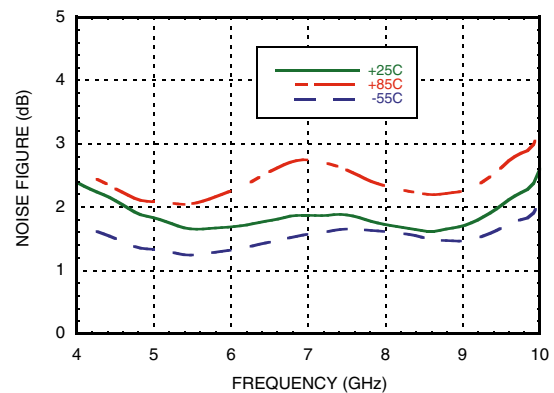

Information furnished by Analog Devices is believed to be accurate and reliable. However, no responsibility is assumed by Analog Devices for its use, nor for any infringements of patents or other rights of third parties that may result from its use. Specifications subject to change without notice. No license is granted by implication or otherwise under any patent or patent rights of Analog Devices. Trademarks and registered trademarks are the property of their respective owners.

For price, delivery, and to place orders: Analog Devices, Inc., One Technology Way, P.O. Box 9106, Norwood, MA 02062-9106 Phone: 781-329-4700 • Order online at [www.analog.com](http://www.analog.com) Application Support: Phone: 1-800-ANALOG-D



**LOW NOISE AMPLIFIER  
MODULE, 5 - 9 GHz**

**Output P1dB vs. Temperature**

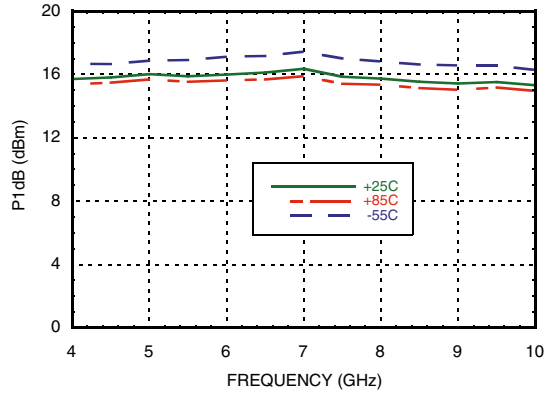

**Psat vs. Temperature**

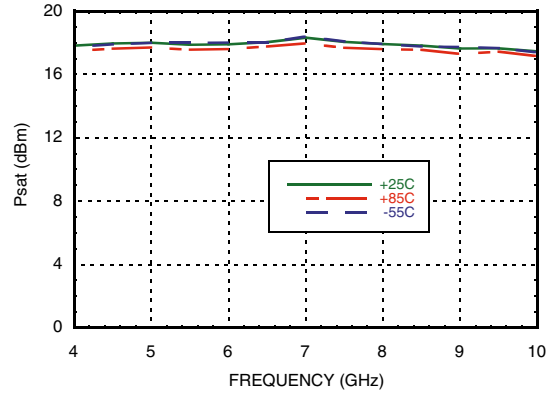

**Output IP3 vs. Temperature**

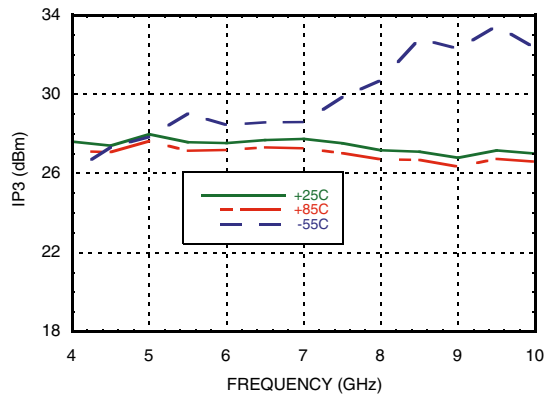

**Absolute Maximum Ratings**

Bias Supply Voltage (Vdc)	+16 Vdc
RF Input Power (RFIN)	+0 dBm
Storage Temperature	-65 to +150 °C
Operating Temperature	-55 to +85 °C





**ELECTROSTATIC SENSITIVE DEVICE  
OBSERVE HANDLING PRECAUTIONS**

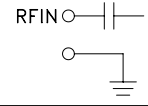

## LOW NOISE AMPLIFIER MODULE, 5 - 9 GHz

### Pin Descriptions

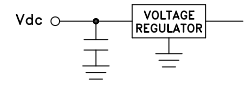
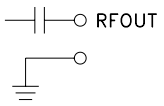
Pin Number	Function	Description	Interface Schematic
1	RFIN & RF Ground	RF input connector, coaxial female, field replaceable. This pin is AC coupled and matched to 50 Ohms.	
2, 5, 6	GND	One of these pins must be connected to power supply ground.	
3	Vdc	Power supply voltage for the amplifier.	
4	RFOUT & RF Ground	RF output connector, coaxial female, field replaceable. This pin is AC coupled and matched to 50 Ohms.	



**LOW NOISE AMPLIFIER  
MODULE, 5 - 9 GHz**

**Outline Drawing**

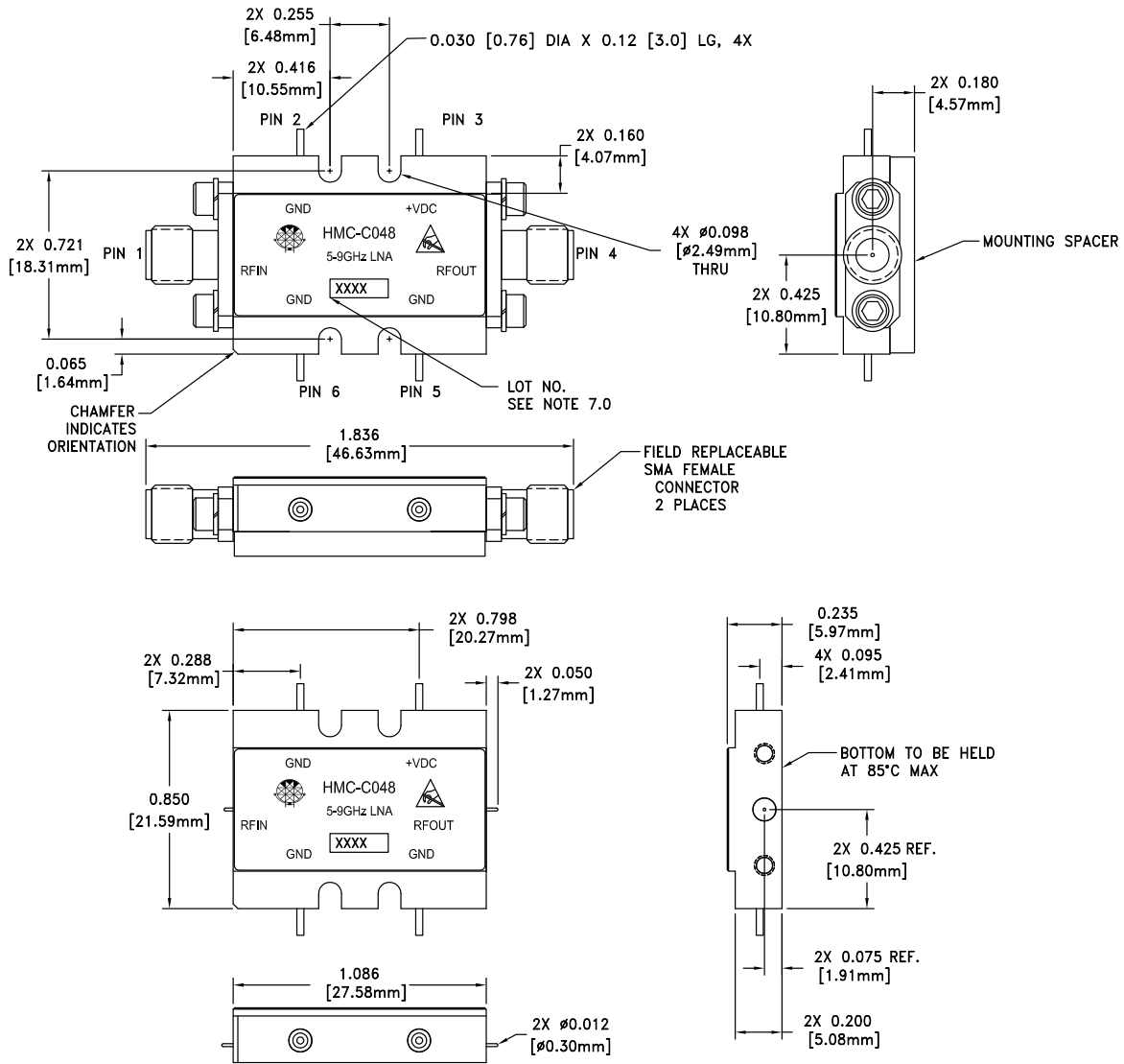

VIEW SHOWN WITH CONNECTORS AND MOUNTING SPACER REMOVED

**Package Information**

Package Type	C-10
Package Weight [1]	18.7 gms [2]
Spacer Weight	3.3 gms [2]

[1] Includes the connectors

[2]  $\pm$ 1 gms Tolerance

**NOTES:**

1. PACKAGE, LEADS, COVER MATERIAL: KOVAR™
2. FINISH: GOLD PLATE OVER NICKEL PLATE
3. ALL DIMENSIONS ARE IN INCHES [MILLIMETERS]
4. TOLERANCES:
  - 4.1 .XX =  $\pm$ 0.02
  - 4.2 .XXX =  $\pm$ 0.010
5. FIELD REPLACEABLE SMA CONNECTORS

**LOW NOISE AMPLIFIER  
MODULE, 5 - 9 GHz****Notes:**