

SERPAC C4

Electronic Enclosures

NOTES:

1) When machine or I-plates modifications are required, use the center of the enclosure to dimension.

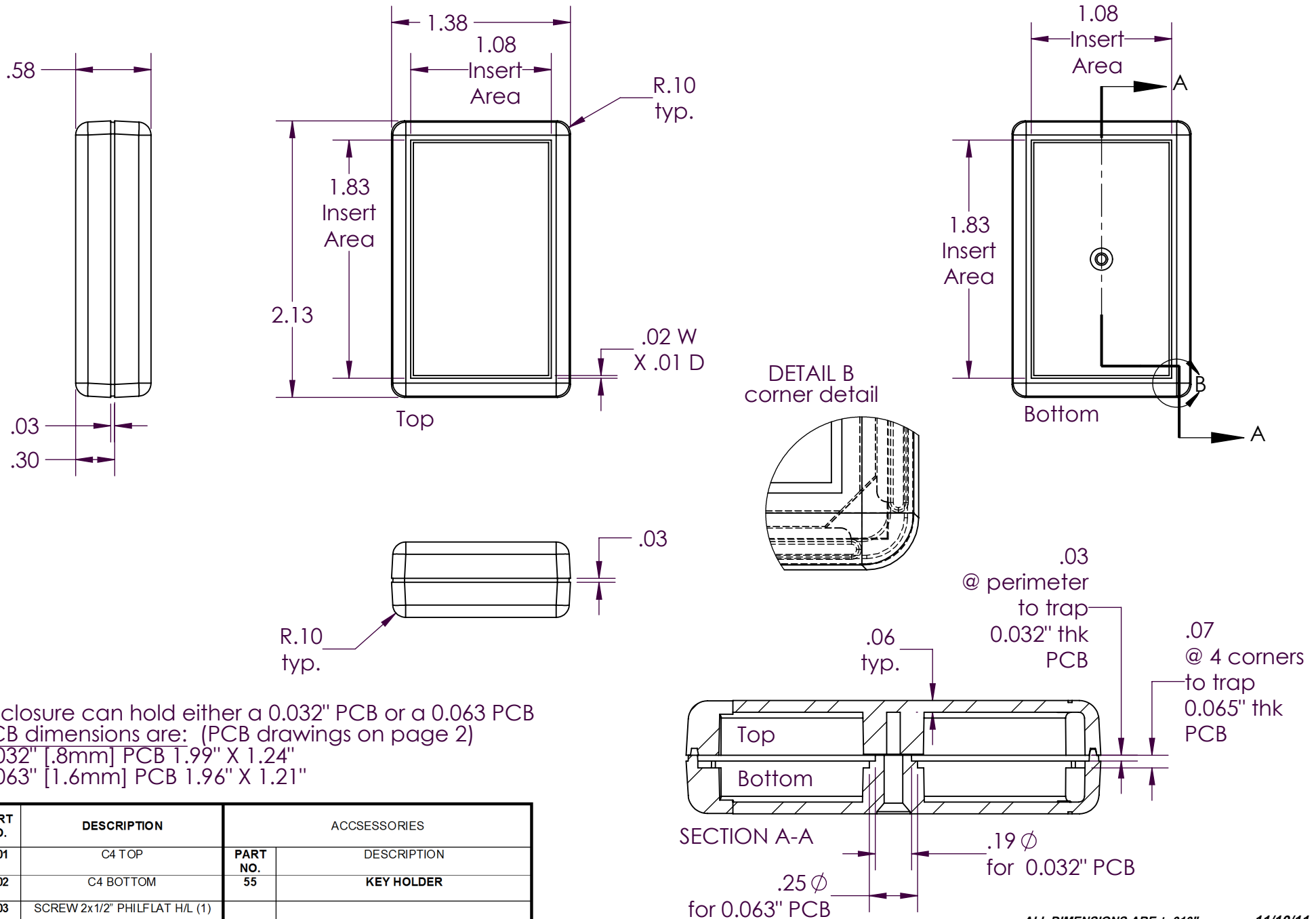

Enclosure can hold either a 0.032" PCB or a 0.063 PCB
 PCB dimensions are: (PCB drawings on page 2)
 0.032" [.8mm] PCB 1.99" X 1.24"
 0.063" [1.6mm] PCB 1.96" X 1.21"

PART NO.	DESCRIPTION	ACCESSORIES	
		PART NO.	DESCRIPTION
1001	C4 TOP	55	KEY HOLDER
1002	C4 BOTTOM		
6003	SCREW 2x1/2" PHILFLAT H/L (1)		

SERPAC CIRCUIT BOARD C4

Electronic Enclosures

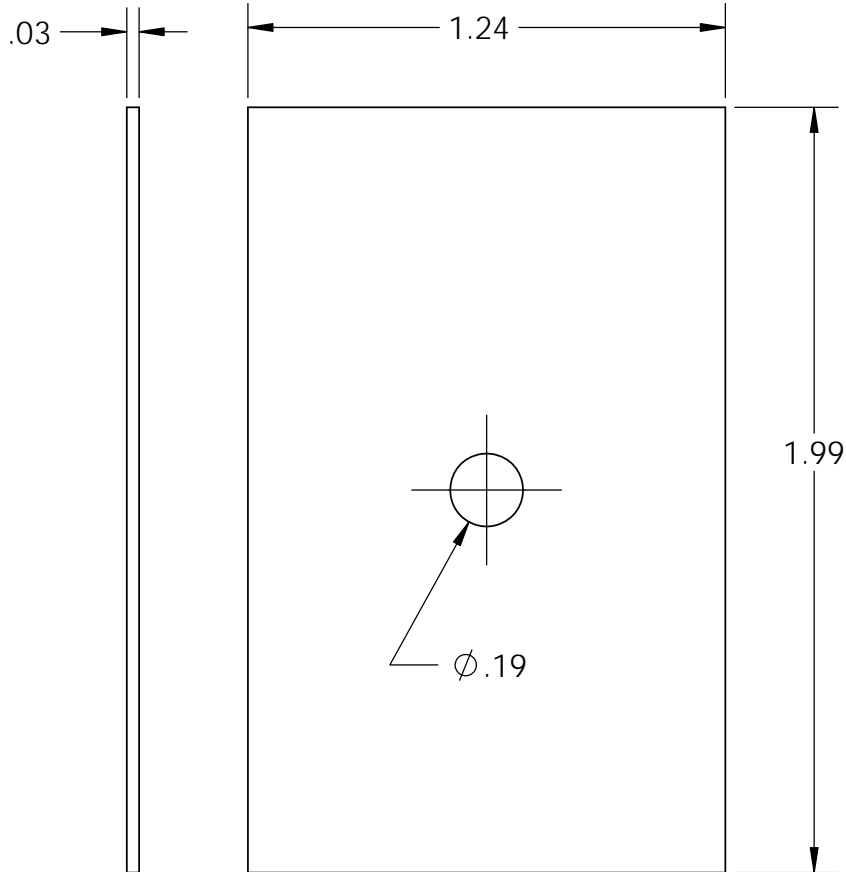

.032 board

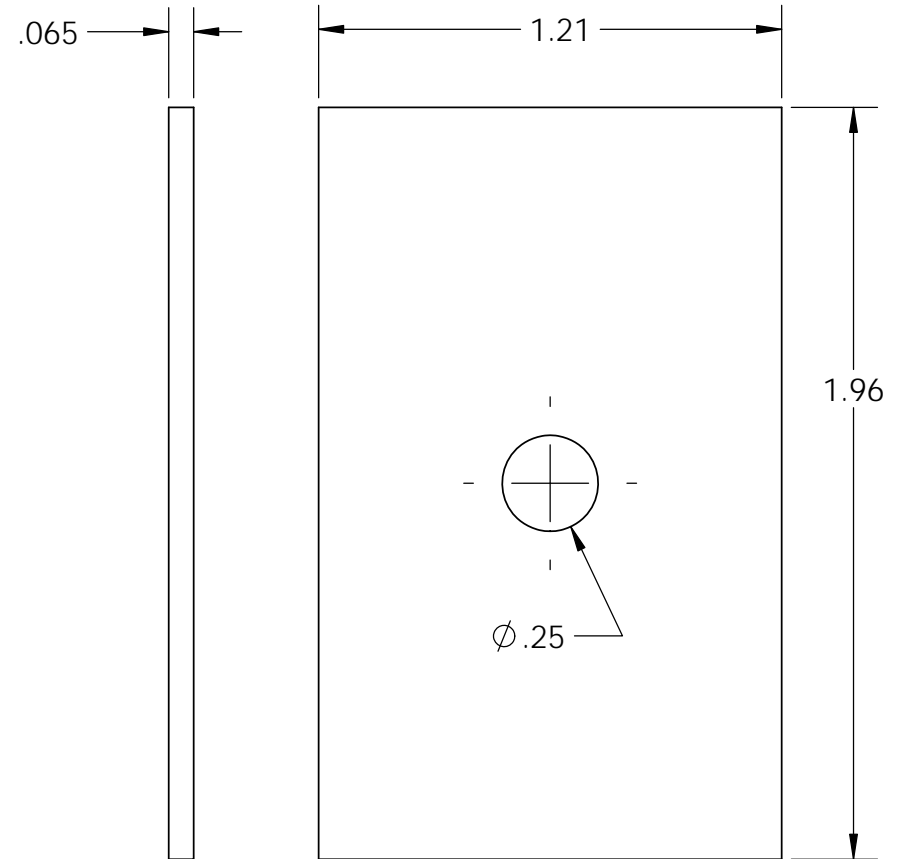

.065 board

NOTES:
These are suggested dimensions.
Plastic parts have a ± 0.010 " manufacturing tolerance.