

REFERENCE DESIGN

IRPLDIM2U rev.a

International Rectifier • 233 Kansas Street, El Segundo, CA 90245 USA

Digital Dimming DALI Ballast for 32W/T8 110V input

By

**Cecilia Contenti and Tom Ribarich (International Rectifier)
and Ross Fosler (Microchip Technology, Inc.)**

FEATURES

- Lamp Type: 1X 32W T8 Lamp
- Line Input: 90-140VAC/60Hz
- Interface DALI (2 wires)
- High Power Factor/ Low THD
- High Frequency Operation
- Programmable Lamp Filament Preheating
- Programmable Ignition
- High precision Digital Dimming
- Logarithmic Dimming
- Diagnostic and fault control
- Lamp Fault Protection
- Brownout Protection
- IR21592 HVIC Ballast Controller
- PIC16F628 Microcontroller
- Optically Isolated Communications
- Low power standby mode

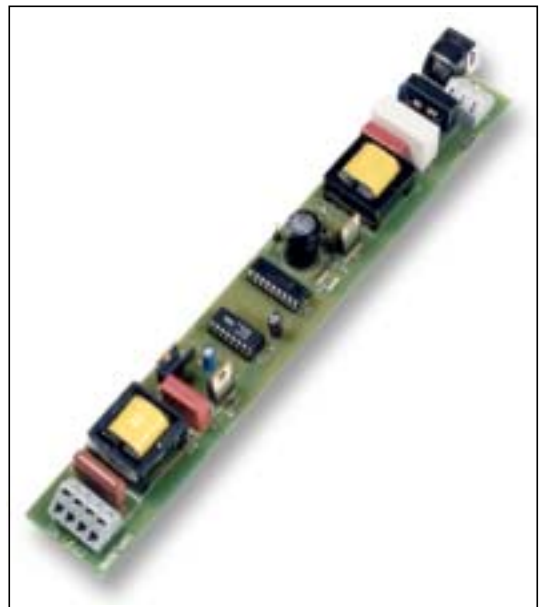

INTRODUCTION

This reference design is a high efficiency, high power factor, digital dimming electronic ballast designed to drive rapid start fluorescent lamp types. The design contains an active power factor correction circuit for universal voltage input as well as a ballast control circuit using the IR21592. The design also includes a PIC16F628 microcontroller and an isolation circuit for connecting to a Digitally Addressable Lighting Interface (DALI). Other features include EMI filtering, transient protection and lamp fault protection.

Digitally Addressable Lighting Interface (DALI)

The Digital Addressable Lighting Interface (DALI), international standard prIEC929, is a communication protocol and method to interface lighting units on a 2-wire network. The DALI protocol is 16 bits and supports addressing up to 64 ballasts individually, 16 groups or broadcasting to the entire lighting network. Aside from the protocol, DALI supports fading, logarithmic dimming, scenes and fault detection.

The DALI allows for a complete lighting environment to be controlled and managed efficiently. The DALI can control (transmit and receive) up to 64 different ballasts with the same control system, transmitting instructions to single ballasts or to a group of ballasts. The ballast provides eye sensitive dimming over a wide range (1-100%). Various operating parameters can be changed and stored dynamically within the ballast memory. For example, scene levels can be set for different groups of ballast. Also, maximum brightness, minimum brightness, fade-time and several other features can be set as desired. Another feature is the ability to diagnose problems such as lamp failures.

Perfect Light Quality

By means of digital control, the light level can be adjusted very precisely according to individual lighting needs. The DALI includes 256 levels of brightness and a logarithmic dimming curve (Figure 2). The use of this curve allows for better control at lower light levels where the human eye is more sensitive.

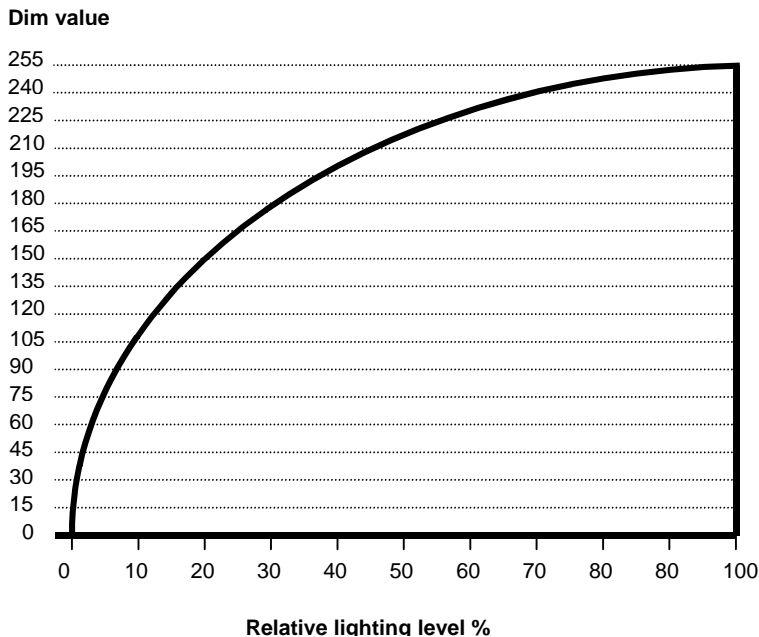

Fig. 2 Dimming Characteristics

FUNCTIONAL DESCRIPTION

The IRPLDIM2U Demo Board consists of an EMI filter, an active power factor correction front end, a ballast control section, a digital control section and a resonant lamp output stage. A block diagram of the design is shown in Figure 3.

The EMI filter blocks ballast generated noise. The power factor correction is used for sinusoidal input current and a regulated DC bus. The ballast control section provides frequency modulation control of a traditional RLC lamp resonant output circuit for preheating, igniting and ballasting the lamp. It is easily adaptable to a wide variety of lamp types. The digital control section provides the Digitally Addressable Lighting Interface (DALI) and the necessary circuitry and software to perform closed-loop dimming, lamp fault detection, shutdown and auto-restart.

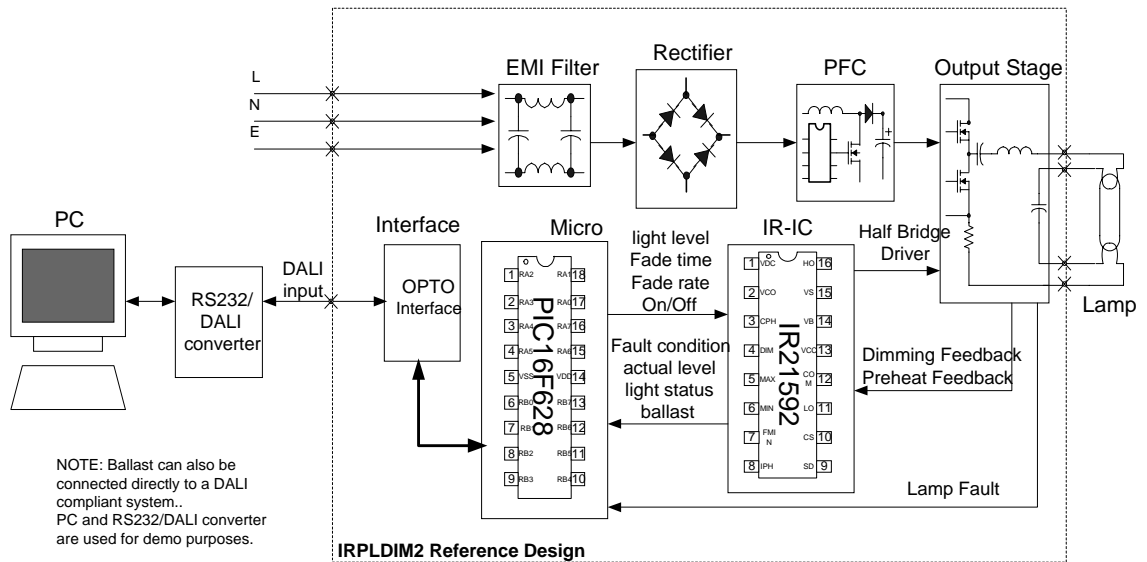

Fig. 3 IRPLDIM2 Block diagram

You can connect the board directly to the DALI input (2 connections) or you can use the RS232/DALI converter board (for demo purposes with the IRPLDIM2U board) to connect it to the PC.

The ballast control circuit uses the IR21592 Dimming Ballast Control IC programmed by the PIC16F628 microcontroller. The IR21592 controls the ballast according to the signals received from the microcontroller. The microcontroller is connected to the ballast and the IC to receive diagnostic signals.

The communication between the ballast and the external world is done with two signals: TX (digital serial signal transmitted from the network to the microcontroller) and RX (digital serial signal from the microcontroller to the network). This system allows the ballast to communicate bi-directionally with the network (a PC or generally a DALI system). A digital interface assures high voltage isolation between DALI inputs and the resonant lamp output stage. The microcontroller manages the communication between interface and ballast IC.

The complete circuit is shown in Appendix A. In the circuit thick races represent high frequency and high current paths. Lead lengths should be minimized to avoid high-frequency noise problems. Appendix B shows the Bill of Materials.

Power Factor Control

The power factor correction section consists of a Power Factor Controller IC (IC1), MOSFET (M1), inductor (L2), diode (D2), capacitor (C6) and additional biasing, sensing and compensation components (see Appendix A: schematics). The power factor correction circuit is a boost converter type running in critical conduction mode. This means that the inductor current discharges to zero each cycle before the boost MOSFET is turned on. The ST L6561D PFC IC is used which shapes the input current to the input voltage while regulating the DC bus voltage at 400 VDC. The IC is chosen for its minimal component count, low start-up supply current and robust error amplifier.

Ballast Control

The ballast control section is built around the IR21592 Dimming Ballast Control IC (IC2). The IR21592 is used for preheating and igniting the lamp, controlling the lamp power and detecting fault condition (over temperature, over current, VCC fault and DC Bus/ AC line fault). The IR21592 contains a voltage-controlled oscillator (VCO) controlling the half-bridge frequency while maintaining a 50% duty cycle, a high voltage half-bridge driver, an amplitude control, fault circuit and an analog dimming interface.

To preheat the lamp, the amplitude control feature of the IR21592 is used, which regulates the resonant tank current during the Preheat period. The VCO starts at maximum frequency and then decreases the frequency until the voltage at the CS pin is equal to the programmed voltage at the IPH pin. The VCO is then adjusted internally (and therefore the frequency) such that the inductor current remains constant until the external capacitor on pin CPH charges above 5.1V. The preheat current (voltage) can be adjusted by increasing or decreasing the resistor on the IPH pin (RIPH) and the preheat time can be adjusted by increasing or decreasing the capacitor on pin CPH (CCPH).

When pin CPH exceeds 5.1V, the IR21592 enables the over-current protection and the next cycle where the CS pin exceeds the internal threshold of 1.6V the half-bridge is disabled. The VCO voltage decreases to a minimum value and the IR21592 starts to decrease the frequency to a minimum frequency which is set by the external resistor on pin FMIN (RFMIN) and the current sensing resistor RCS. In this way it generates a high voltage for igniting the lamp. This voltage can be adjusted by adjusting RCS.

When the lamp is successfully ignited, The IR21592 regulates the phase angle of the inductor current with respect to the half bridge voltage to regulate the lamp power. This is done by measuring the zero crossing of the current and regulating it against the reference angle from the dimming interface. The IR21592 provides a 0-to-5 VDC dimming interface which converts the analog input voltage to an internal phase angle reference for controlling the lamp power. The DIM pin is a high impedance analog control input and the RMAX and RMIN pins set the maximum and minimum angles boundaries. The RMIN resistor sets the minimum lamp power at 1% when VDIM=0V and the RMAX resistor sets the maximum lamp power at 100% when VDIM=5V.

Digital Control

The digital control section is built around the PIC16F628 Microchip microcontroller. This microcontroller acts as an interface between the IR21592 ballast controller and the Digitally Addressable Lighting Interface (DALI). Data is transmitted to the unit and the PIC16F628 collects the data through an isolation circuit. It then interprets the data and sends the appropriate signals to the ballast controller IR21592 if necessary or sends information back to the DALI. The PIC16F628 also performs fault detection and disables the IR21592 if a fault is present.

BALLAST DESIGN

The ballast design incorporates two parts, hardware and software. The ballast controller design portion incorporates most of the hardware design. The digital design control portion incorporates most of the software design. Appendix A shows the complete schematic and Appendix B the Bill of Materials.

The Ballast Controller Design

The design of the Ballast control portion of the circuit has been accomplished in International Rectifier's Reference Design IRPLDIM1. Refer to this for waveforms and specific calculations regarding the ballast controller portion of this design.

Signals of the IR2159

The communication between the microcontroller and the IR21592 is done with four signals, as shown in Fig. 4. These signals are used for digital dimming (RB3), turning the ballast on or off (RB4), and fault detection (RB5 & RB6). The microcontroller controls the IR21592 by the following 3 pins: pin SD for shutdown of the IC (active high), pin FMIN used for fault detection (0 if the IC is in fault mode) and pin DIM to control the brightness. The microcontroller receives lamp information by the signal Lamp-out, connected to the lamp.

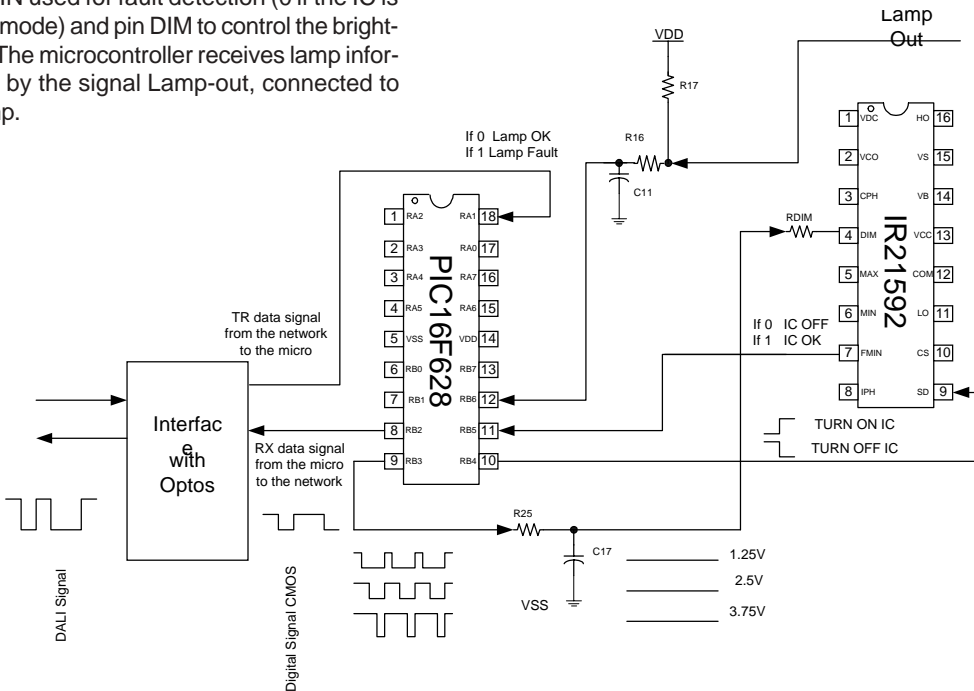

Fig. 4 Micro/IR21592 Communication

The shutdown signal (RB4) enables or disables the IR21592. When high, the lamp is off and the IR21592 is disabled with minimal current flowing. When low, the lamp is on. The PIC16F628 has control of this line and determines if lamp should be on or off based on fault conditions and user requested settings from the DALI. There are two signals used for fault detection, lamp-out (RB6), and fault (RB5). The lamp-out signal indicates the presence of a lamp or lamp fault. When the lamp is removed the lamp-out signal is pulled up to VDD by the pull-up resistor R17 and the software forces the IR21592 to shutdown. When the lamp is changed, this pin goes to 0 Volts, the microcontroller turns the IR21592 on again and the lamp re-starts automatically. Other fault conditions are indicated by the fault signal (pin FMIN of the IR21592). A low on the fault signal indicates that the IR21592 is in a fault state (the IR21592 turns off automatically in fault conditions such as VCC fault, over-current, failure to strike or low AC line and will remain in this FAULT state until the IC is reset).

The IR21592 requires a 0.5-volt to 5-volt analog voltage (in pin DIM) to perform dimming, thus 0.5 volts corresponds to the 1% arc power level and 5 volts corresponds to the 100% arc power level. The PIC16F628 provides a pulse width modulated signal on pin RB3 that is filtered with a single RC network (R25 and C17). This provides an analog voltage for dimming. The micro can change the dim voltage from 0.5V to 5V by changing the duty cycle and therefore generate 256 different voltage levels for the IR21592. To conform to the digital dimming requirements, the output is logarithmic rather than linear. Since the human eye is much more sensitive to lower light levels than high levels, the logarithmic output appears to be linear. Therefore the PIC16F628 is programmed to produce a logarithmic voltage and the IR21592 drives the lamp arc power (Figure 5).

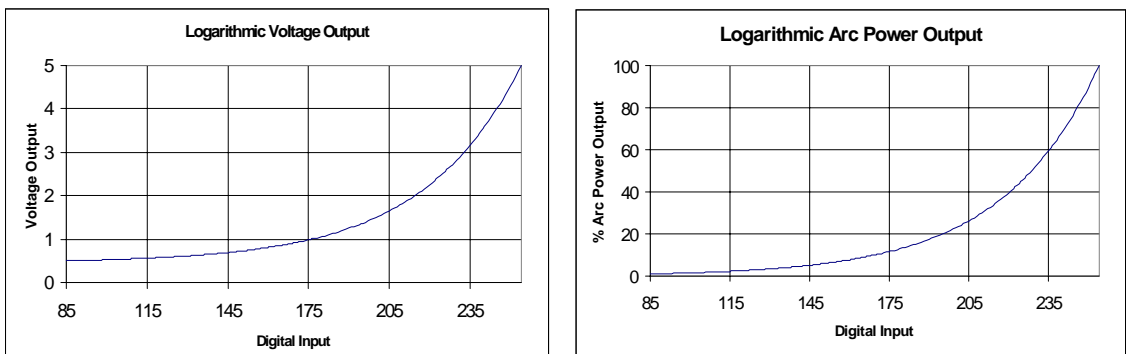

Fig. 5 Dimming Characteristics

The microcontroller can also change the fade time by controlling the speed in which the duty cycle changes. The relation between light level and dim level can be tuned according to specific needs. The minimum light level can be changed by adjusting RMIN, and the maximum level can be changed adjusting RMAX. RMIN sets the lower phase boundary corresponding to minimum lamp power when VDIM = 0.5V, and RMAX sets the upper phase boundary corresponding to maximum lamp power when VDIM = 5V. RMAX must be set after RMIN.

The software

The software to implement the DALI is quite large but simple to understand when broken into some elementary functional blocks. Figure 6 outlines the basic flow of the software in its most simplified form (the details source code is available in a CD enclosed with the Reference Design Kit).

Upon entry into the program after setup the microcontroller is held in a loop. While in this loop the microcontroller is checking for errors, plus it is polling the communications circuitry for incoming data. If valid data is received, it is filtered to determine if the address matches the defined address for the ballast, if the group matches the defined group memberships, or if the data is a broadcast command. Also, the type of command is filtered into two basic choices, standard or special. Once filtered, the program immediately vectors to the appropriate command and executes. All of the commands are divided into four general categories including arc power control commands, configuration commands, query commands, and special commands. Within each category the commands are divided again according to related functions.

The arc power control commands are the most commonly used in a functioning lighting system. Within any of these commands appropriate signals are sent to the ballast controller to adjust light level via pulse width modulation. This includes scene level selections. Also many of the commands in this group select the shutdown bit, depending on the definition of the command.

Configuration commands are used to setup the ballast. Examples of such settings include setting minimum and maximum lighting thresholds, fade times and rates, groups, and scene levels. Generally data is stored in an EEPROM storage area where it is maintained regardless of the power conditions.

Query commands are used to get feedback from the ballast. All of the settings can be queried. Even more useful, the status of the ballast is available. Information about fading, the lamp, general faults, and power is available through the appropriate query command.

Special commands are unique. These commands are immune to addresses; thus all ballasts on the

Digitally Addressable Lighting Interface respond to a special command. All the functions for finding new ballasts or ballasts that have no addresses are available. Uploading information to the ballast, typically settings, is also available in the special command set.

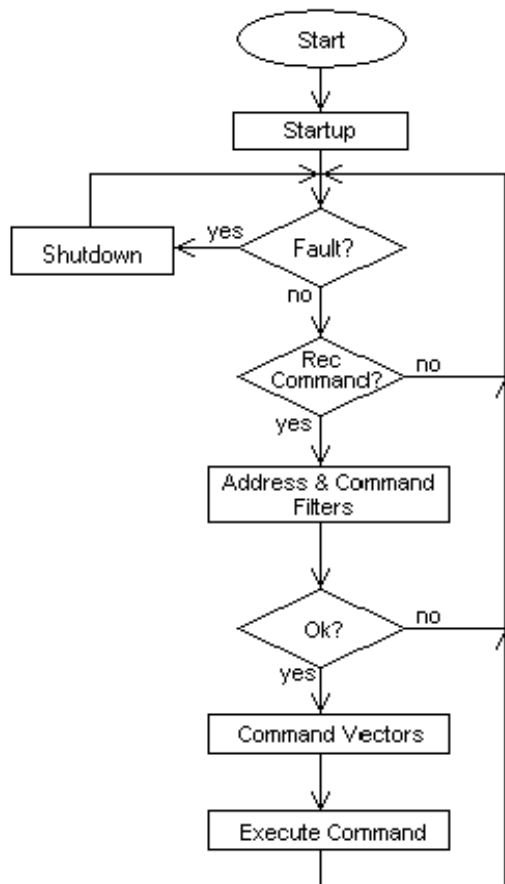

Fig. 6 Program Flow

Isolation and the Signals for DALI

The Digitally Addressable Lighting Interface is optically isolated from the microcontroller. Fig. 7 shows the connections between DALI and microcontroller.

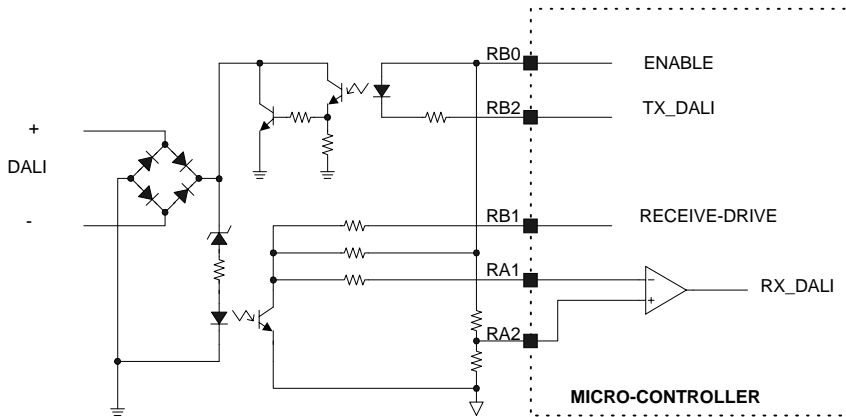

Fig. 7 DALI and Micro Controller connections

The two wires from the DALI are converted to four signals. Two of the four are the transmit signal (RB2) and receive signal (RX_DALI). The other two signals are the communications-enable (RB0) signal and the receive-drive (RB1) signal. The transmit signal and the receive signal directly correlate to the levels seen on the Digitally Addressable Lighting Interface. For receiving higher voltage logic on the DALI is translated to 5 volt logic at the micro controller, and for transmission, the 5 volt logic is translated to the higher voltage logic on the DALI.

The ballast achieves very low power by controlling the communications circuit with the communication-enable signal and the receive-drive signal. During normal operation the PIC16F628 enables the communication circuitry with the communication-enable signal. With this signal there is enough current, less than 100uA, to indicate when data is being sent to the ballast, but not enough current to accurately transfer the data. Upon detection (done by a S/H built into the PIC16F628) the receive-drive is asserted to raise the current above 500uA to achieve good signal transfer across the isolation. The receive-drive signal is only enabled long enough to transfer all the data; then it is disabled (see waveforms in figure 8). This method strongly reduces the power/current use. The comparator built into the PIC16F628 is used to set the threshold for detection of the incoming data. The signal RA2 is used as threshold for the comparator.

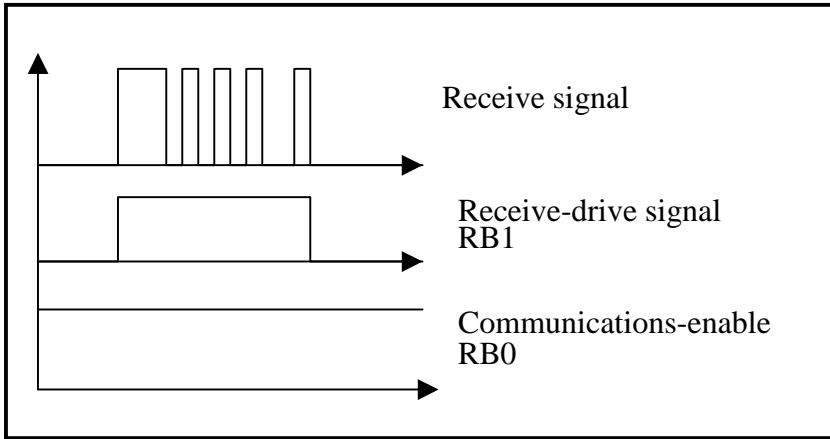

Fig. 8 Dali and Micro-Conttoller signals

Shutdown and Low Power

With shutdown there are some unique power conditions. With the shutdown line low and the lamp ignited, the PIC16F628 derives its power from the charge pump of the IR21592. The charge pump provides enough current for the microcontroller to run at its internal frequency of 4MHz during normal operation. When the shutdown line is asserted the IR21592 is disabled, and the charge pump is no longer functioning. Current is drawn directly from the high voltage DC line through a high value resistor. The micro controller is put to sleep during this time to minimize current draw and power dissipation. To receive data, which requires significant current, the PIC16F628 wakes up and starts the charge pump of the IR21592 long enough to process the command, typically less than 25ms, but not long enough to ignite the lamp (see waveforms in Figure 9). Doing this unique management minimizes power dissipation during shutdown.

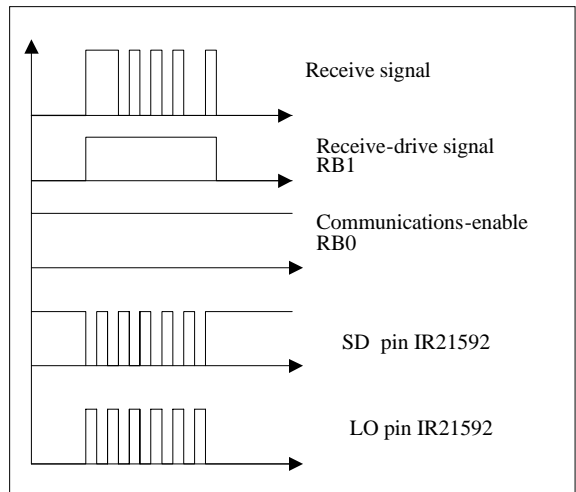

Fig. 9 Communications signal with the lamp off

<i>Memory Type</i>	Size	Used	%
Program	2181	1918	87.94%
Data	224	71	31.70%
EE Data	128	35	27.34%

CONCLUSION

International Rectifier and Microchip Technology Inc., jointly developed a solution for the digital dimming ballast. It conforms to DALI standard requiring very few parts and operates at very low power. This is a good example of merging digital technology with high voltage analog technology.

DISCLAIMER

The information provided herein is for suggestion only. It is your responsibility to ensure that your application meets with your specifications. No representation of warranty is given or liability assumed by Microchip Technology, Inc or International Rectifier either indirectly or with respect to the accuracy of such information on intellectual property infringements.

References

- [1] T. Ribarich, J. Ribarich, "A New Design Procedure for High-Frequency Ballast Design", in IEEE-IAS Conf. Rec., 1997, pp. 2334-2339
- [2] T. Ribarich, J. Ribarich, "A New Control Method for Dimmable High Frequency Electronic Ballast", in IEEE-IAS Conf. Rec., 1998
- [3] T. Ribarich, J. Ribarich, "A New High-Frequency Fluorescent Lamp Model", in IEEE-IAS Conf. Rec., 1998
- [4] International Rectifier, "IR21592/IR21593 Dimmable Ballast Controller IC".
- [5] International Rectifier, Reference Design IRPLDIM1.

Appendix A: IRPLDIM2 Schematic

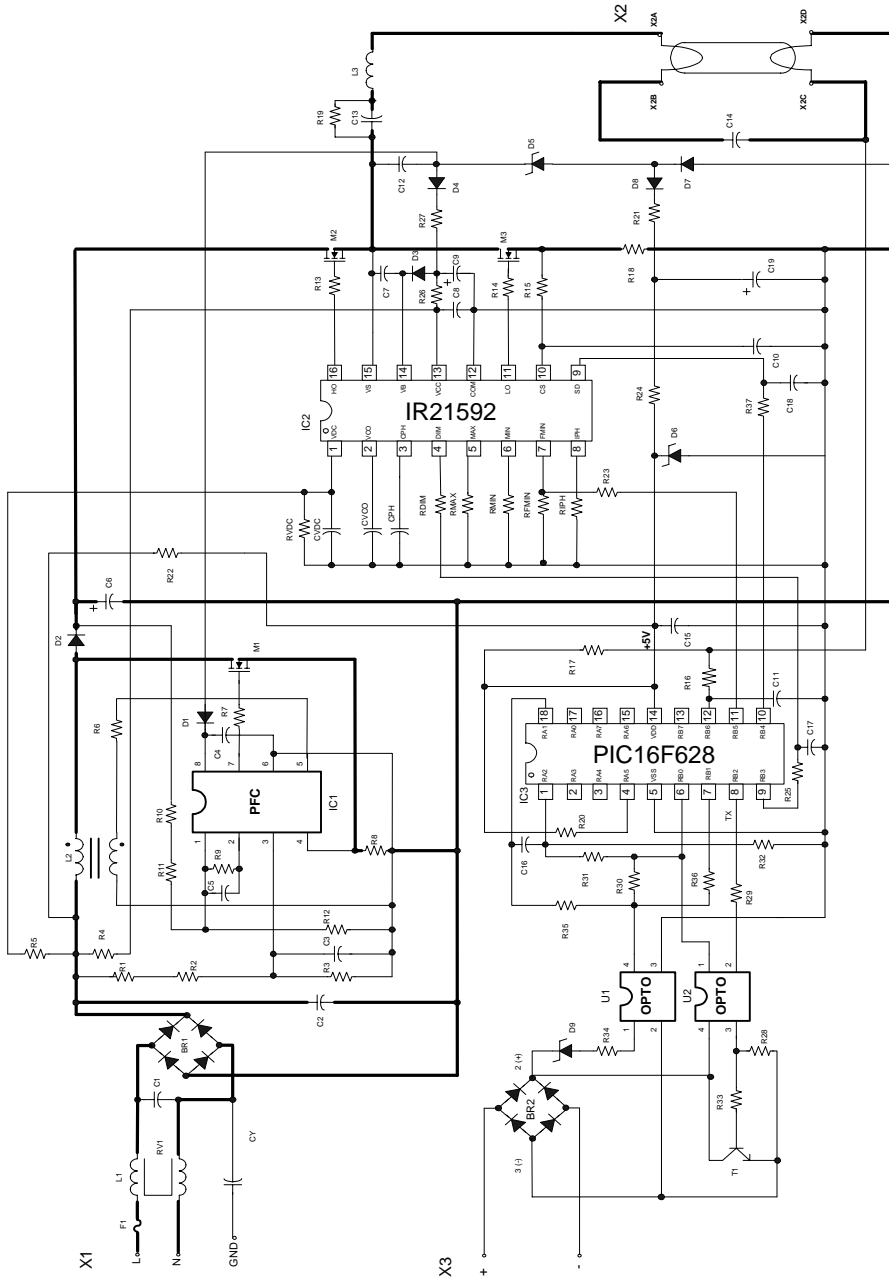

IRPLDIM2U Bill of Materials
Lamp Type: T8/32W Line Input Voltage: 90 to 140 VAC

ITEM	Qty	Reference	Description	Manufacturer	PN
1	1	BR1	Bridge Rectifier, 1A, 1000V	IR	DF10S
2	2	C4, C5	Capacitor, 0.47uF, SMT 1206	Panasonic	ECJ-3YB1E474K
3	1	C3	Capacitor, 0.01uF, SMT 1206	Panasonic	ECU-V1H103KBM
4	1	C1	Capacitor, 0.33uF, 275VAC	Roederstein	F1772433-2200
5	2	CPH, CVDC	Capacitor, 0.39uF, SMT 1206		
6	2	C2, C13	Capacitor, 0.1uF, 400VDC	Wima	MKP10
7	4	C7, C8, C11, C18	Capacitor, 0.1uF, SMT1206	Panasonic	ECJ-3VB1E104K
8	1	C15	Capacitor, 0.22uF, SMT1206	Panasonic	
9	1	C6	Capacitor, 10uF, 350VDC,105C	Panasonic	
10	1	C9	Capacitor, 4.7uF, 25VDC, 105C	Panasonic	EEU-FC1H4R7
11	1	C19	Capacitor, 10uF, 25VDC, 105C	Panasonic	
12	1	C10	Capacitor, 100pF, SMT 1206	Panasonic	ECU-V1H471KBM
13	1	C16	Capacitor, 1nF, SMT 1206	Panasonic	
14	1	C12	Capacitor, 1.5nF, 1KV, SMT 1812	Johanson	
15	1	C14	Capacitor, 8.2nF, 1600VDC	Panasonic	
16	1	CVCO	Capacitor, 22nF, SMT 1206		
17	1	C17	Capacitor, 1uF, SMT 1206		
18	1	CY	Y-Capacitor		
19	2	D4, D7	Diode, 1N4148, SMT DL35	Diodes	LL4148
20	2	D1, D8	Diode, 1N4148	Diodes	
21	2	D2, D3	Diode, 1A 600V SMB	Digi-Key	MURS160DICT-ND
22	1	D5	12 V Zener SMT	Digi-Key	ZMM5242BDCT-ND
23	1	D9	5.1 V Zener SMT	Digi-Key	ZMM5231BDCT-ND
24	1	D6	5.6V Zener SMT	Digi-Key	ZMM5232BDCT
25	1	L1	EMI Inductor, 1x10mH, 0.7A	Panasonic	ELF-15N007A
26	1	L2	PFC Inductor, 2.0mH, 2.0Apk	Coilcraft	Z9264-B
27	1	L3	Inductor, 2.0mH, 2.0Apk	Coilcraft	Z9265-B
28	1	M1	Transistor Mosfet	IR	IRF730
29	2	M2, M3	Transistor Mosfet	IR	IRF720
30	1	R15	Resistor, 1K Ohm, SMT 1206	Panasonic	ERJ-8GEYJ1KV
31	1	R33	Resistor, 470 Ohm, SMT 1206	Panasonic	
32	1	RFMIN	Resistor, 39K Ohm, 1%, SMT 1206	Panasonic	
33	5	RDIM, R20, R34, R35, R36	Resistor, 10K Ohm, SMT 1206	Panasonic	ERJ-8GEYJ10KV
34	1	RIPH	Resistor, 17.4K Ohm, 1%, SMT 1206	Panasonic	
35	1	R12	Resistor, 12.4KOhm, 1% , SMT 1206	Panasonic	
36	1	RVDC	Resistor, 47K Ohm, SMT 1206	Panasonic	
37	1	RMIN	Resistor, 26.1KOhm, 1%, SMT 1206	Panasonic	
38	1	RMAX	Resistor, 25.5K Ohm, 1%, SMT 1206	Panasonic	
39	2	R1, R2	Resistor, 680KOhm, SMT 1206	Panasonic	ERJ-8GEYJ680KV
40	1	R3	Resistor, 7.5K Ohm, SMT 1206	Panasonic	ERJ-8GEYJ7.5KV
41	1	R6	Resistor, 22K Ohm, SMT1206	Panasonic	ERJ-8GEY22KV
42	5	R7, R13, R14, R21, R24	Resistor, 22 Ohm, SMT 1206	Panasonic	ERJ-8GEY22V

43	3	R9, R16, R30	Resistor, 100KOhm, SMT 1206	Panasonic	ERJ-8GEY100KV
44	2	R10, R11	Resistor, 820KOhm, SMT 1206	Panasonic	ERJ-8GEY820KV
45	1	R17	Resistor, 1M Ohm, SMT1206	Panasonic	ERJ-8GEY1MV
46	1	R8	Resistor, 1 Ohm, 1/2 Watt	Yageo	1.0QBK
47	1	R18	Resistor, 0.75 Ohm, 1/2 Watt	Yageo	
48	1	R19	Resistor, 100K Ohm, 1/2 Watt	Yageo	
49	1	R4	Resistor, 330 K Ohm, 1/2W	Yageo	
50	1	R5	Resistor, 1M Ohm, 1/2W	Yageo	
51	2	R26, R27	Resistor, 10 Ohm, SMT1206	Panasonic	
52	1	R22	Resistor, 130 K Ohm, 0.5W	Yageo	
53	1	R23	Resistor, 470 KOhm, SMT1206	Panasonic	
54	1	R31	Resistor, 360KOhm, SMT1206	Panasonic	
55	1	R28	Resistor, 4.7 KOhm, SMT 1206	Panasonic	
56	1	R29	Resistor, 2.2 KOhm, SMT 1206	Panasonic	
57	1	R32	Resistor, 75K, SMT 1206	Panasonic	
58	2	R25, R37	Resistor, 47 KOhm, SMT1206	Panasonic	
59	1	F1	Resistor, 0.5 Ohm, 1/2 Watt	Dale	CW-1/2
60	1	IC1	PFC IC for PWR FACTOR	ST	L6561D
61	1	IC2	IC, Dimming Ballast Controller	IR	IR21592
62	2	U1, U2	Mini-flat package Photo coupler	SHARP	PC357NT
63	1	U3	Micro-controller PDIP	Microchip	PIC16F628P
64	1	T1	SOT23 MP Transistor NPN	Digi-Key	FMMT491ACT-ND
65	1	BR2	.5A 200V Mini SM Bridge Rect.	General Semiconductors	MB2S
66	1	X1	Connector, 3 terminals	Wago	235-203
67	1	X2	Connector, 4 terminals	Wago	235-204
68	1	X3	Phone Connector RJ11		
69	7	J1, J2, J3, J4, J5, J6, J7	Jumper		
70	8	R01, R02, R03, R04, R05, R06, R07, R08	Resistor, 0 Ohm, SMT 1206		

REVISION HISTORY FOR REFERENCE DESIGN IRPLDIM2U

Date	Change
August 8, 2008	Added "Not recommended for new designs – please refer to IRPLDIM3"