

□

Adafruit MAX31856 Universal Thermocouple Amplifier

Created by lady ada

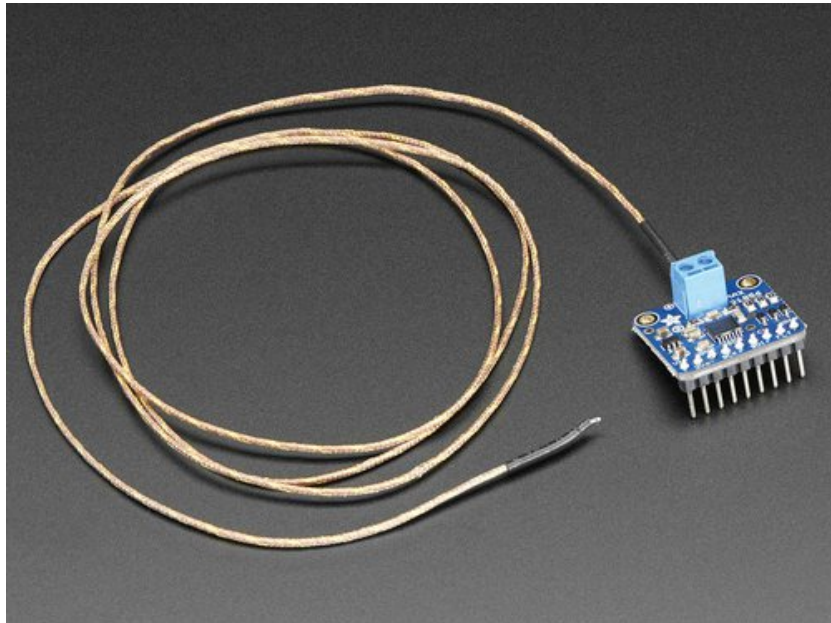

Last updated on 2016-09-26 05:53:09 PM UTC

Guide Contents

Guide Contents	2
Overview	3
Pinouts	6
Power Pins:	6
SPI Logic pins:	6
Additional Pins	7
Assembly	8
Prepare the header strip:	8
Add the breakout board:	8
And Solder!	9
Wiring & Test	14
SPI Wiring	14
Download Adafruit_MAX31856 library	15
Attach Thermocouple	15
Load Demo	16
Library Reference	18
Faults	19
Downloads	21
Files	21
Schematic	21
Fabrication Print	21

Overview

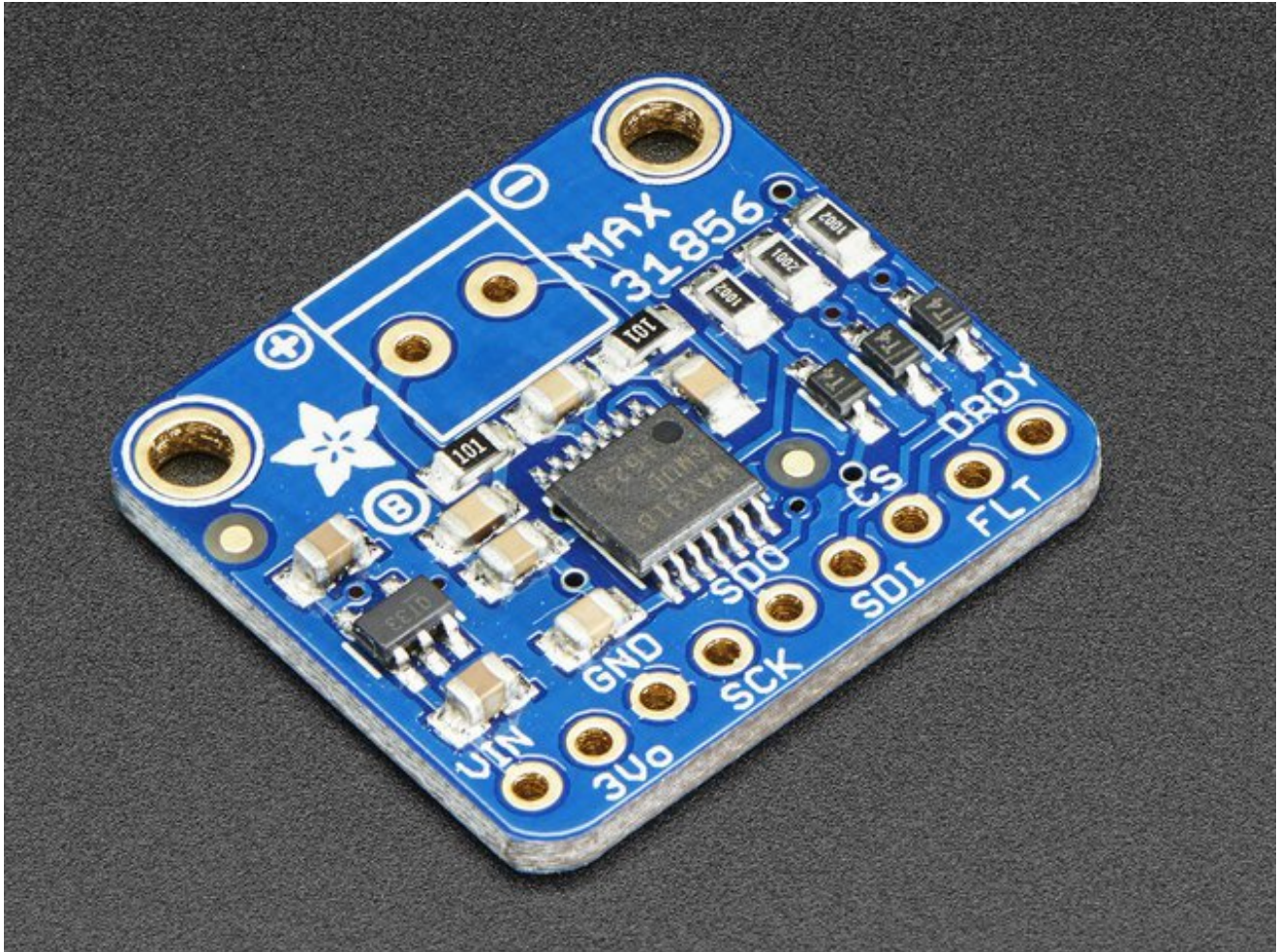

Thermocouples are very sensitive, requiring a good amplifier with a cold-compensation reference, as well as calculations to handle any non-linearities. For a long time we've suggested our MAX31855K breakout, which works great but is only for K-type thermocouples. Now we're happy to offer a great new thermocouple amplifier/converter that can handle just about *any* type of thermocouple, and even has the ability to give you notification when the temperature goes out of range, or a fault occurs. Very fancy!

This converter communicates over 4-wire SPI and can interface with any **K**, **J**, **N**, **R**, **S**, **T**, **E**, or **B** type thermocouple

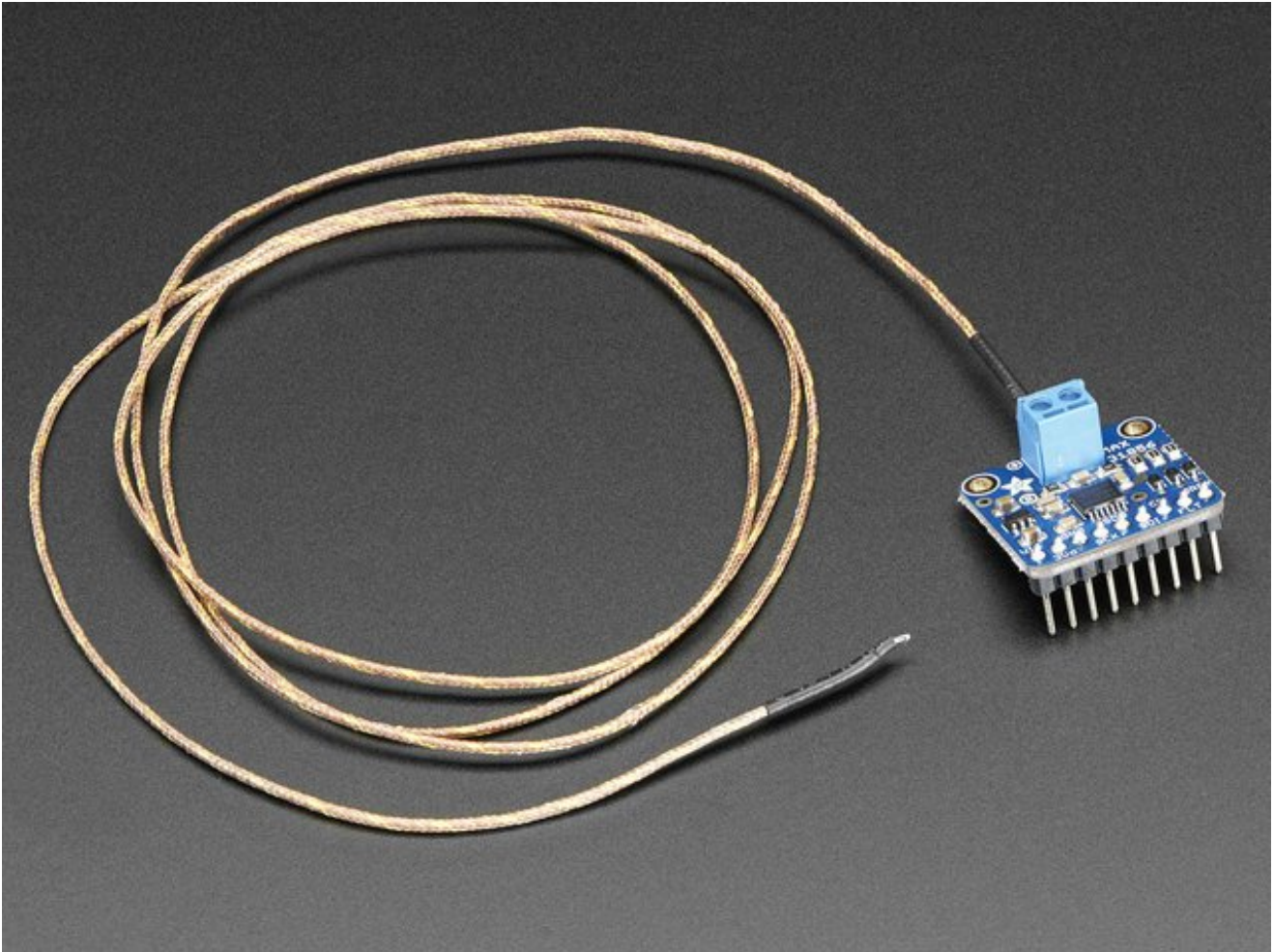

This breakout does everything for you, and can be easily interfaced with any microcontroller, even one without an analog input. This breakout board has the chip itself, a 3.3V regulator and level shifting circuitry, all assembled and tested. Comes with a 2 pin terminal block (for connecting to the thermocouple) and pin header (to plug into any breadboard or perfboard). We even added inline resistors and a filter capacitor onboard for better stability, as recommended by Maxim. [Goes great with our 1m K-type thermocouple \(http://adafruit.it/270\)](http://adafruit.it/270) or any other thermocouple, really!

- Works with any **K, J, N, R, S, T, E, or B** type thermocouple
- **-210°C to +1800°C output in 0.0078125° resolution**- note that many thermocouples have about $\pm 2^\circ\text{C}$ to $\pm 6^\circ\text{C}$ accuracy or worse depending on the temperature and type, so the resolution will be a lot better than the accuracy!
- Internal temperature reading
- 3.3 to 5v power supply and logic level compliant!
- SPI data requires any 4 digital I/O pins.

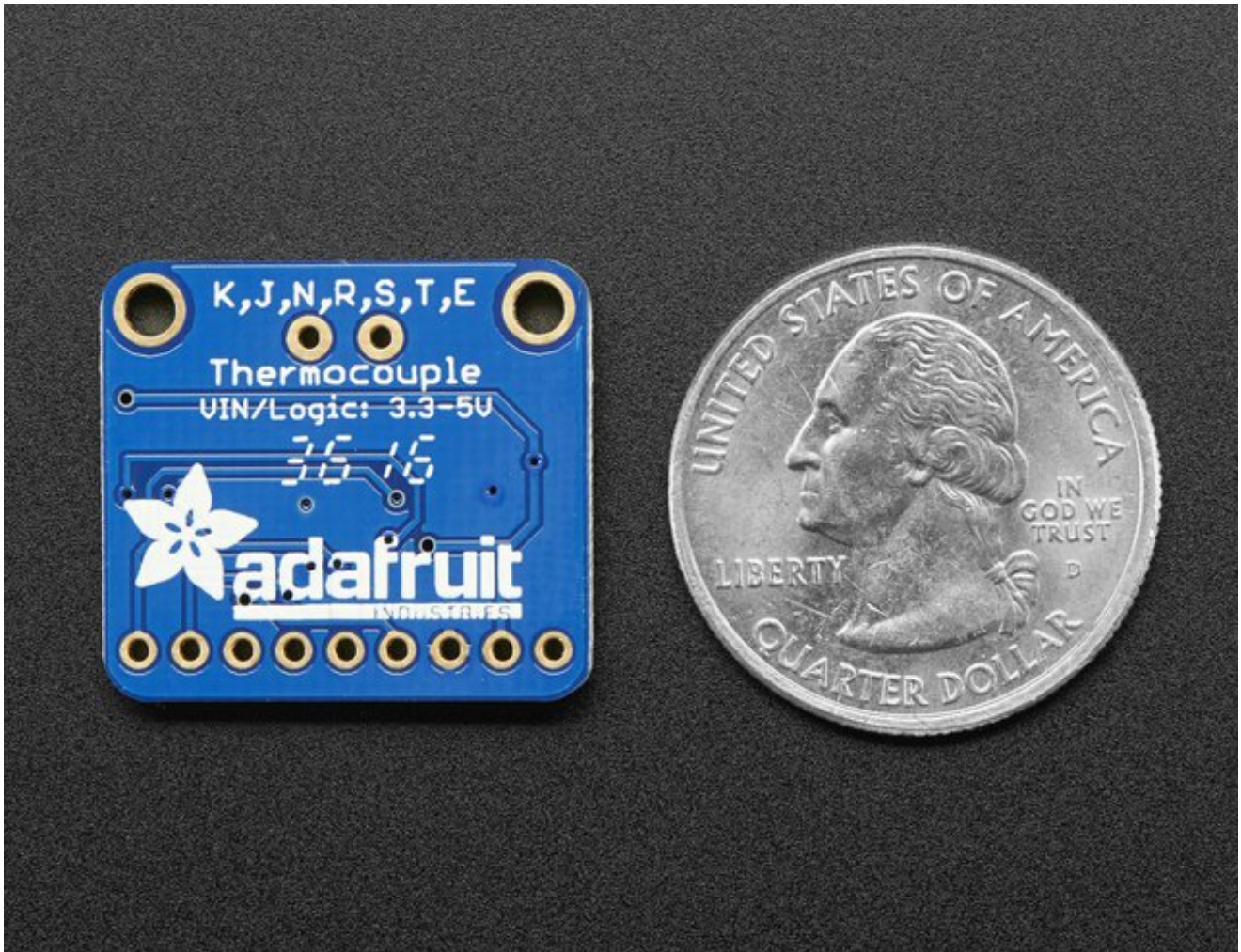

Pinouts

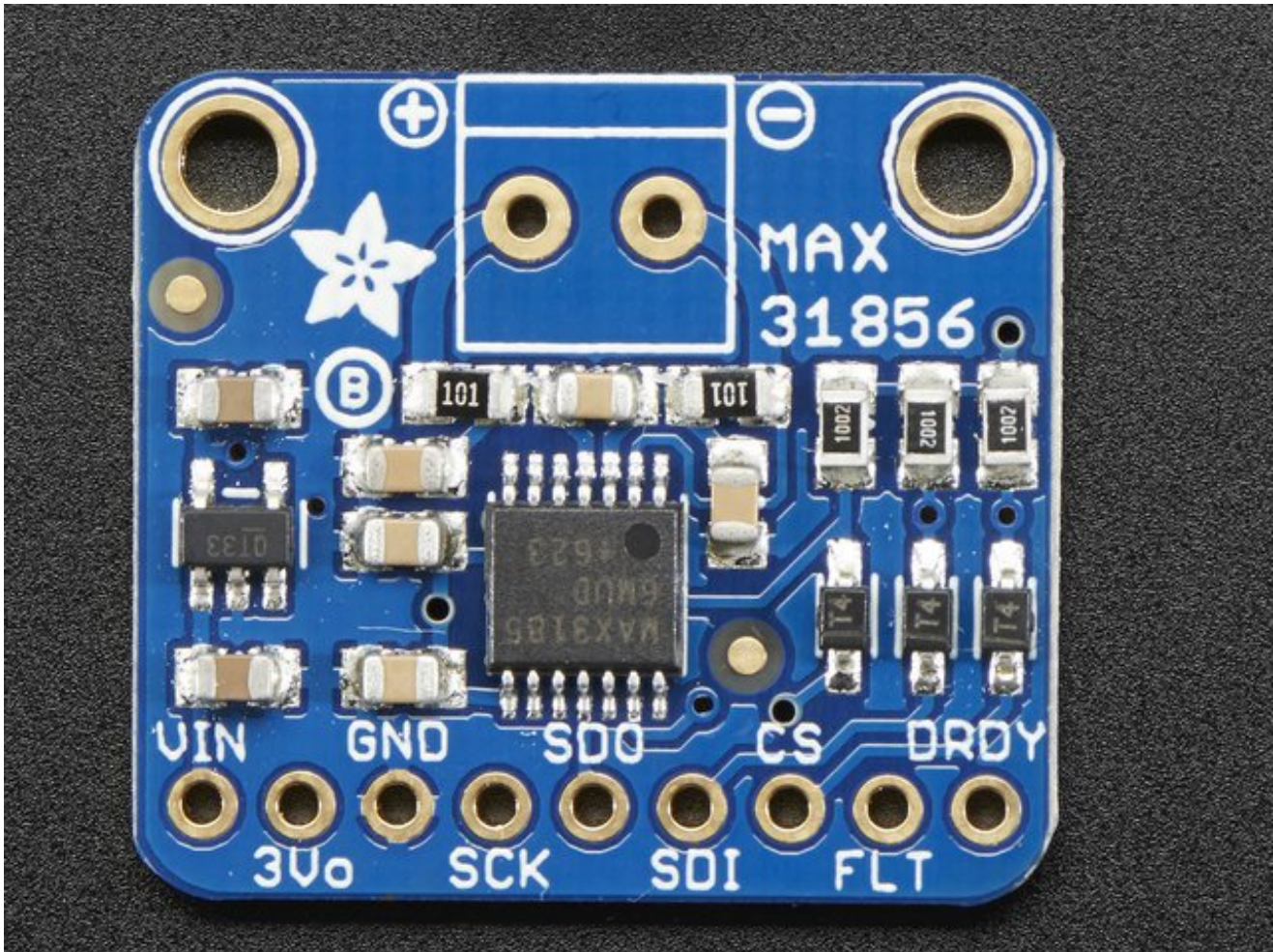

Power Pins:

- **Vin** - this is the power pin. Since the sensor chip uses 3 VDC, we have included a voltage regulator on board that will take 3-5VDC and safely convert it down. To power the board, give it the same power as the logic level of your microcontroller - e.g. for a 5V micro like Arduino, use 5V
- **3Vo** - this is the 3.3V output from the voltage regulator, you can grab up to 100mA from this if you like
- **GND** - common ground for power and logic

SPI Logic pins:

All pins going into the breakout have level shifting circuitry to make them 3-5V logic level safe. Use whatever logic level is on **Vin!**

- **SCK** - This is the **SPI Clock** pin, its an input to the chip
- **SDO** - this is the **Serial Data Out / Master In Slave Out** pin, for data sent from the MAX31856 to your processor
- **SDI** - this is the **Serial Data In / Master Out Slave In** pin, for data sent from your processor to the MAX31856
- **CS** - this is the **Chip Select** pin, drop it low to start an SPI transaction. Its an input to the chip

If you want to connect multiple MAX31856's to one microcontroller, have them share the SDI, SDO and SCK pins. Then assign each one a unique CS pin.

Additional Pins

There's two more pins that are available for advanced usage

- **FLT** - This is the **Fault** output. If you use the threshold-notification capabilities of the MAX31856 you can monitor this pin, when it goes low there's a fault!
- **DRDY** - This pin is used for advanced uses where you tell the sensor to begin a reading and then wait for this pin to go low. We don't use it in our library code because we keep it simple with a delay/wait, but it is available in case you need it!

Assembly

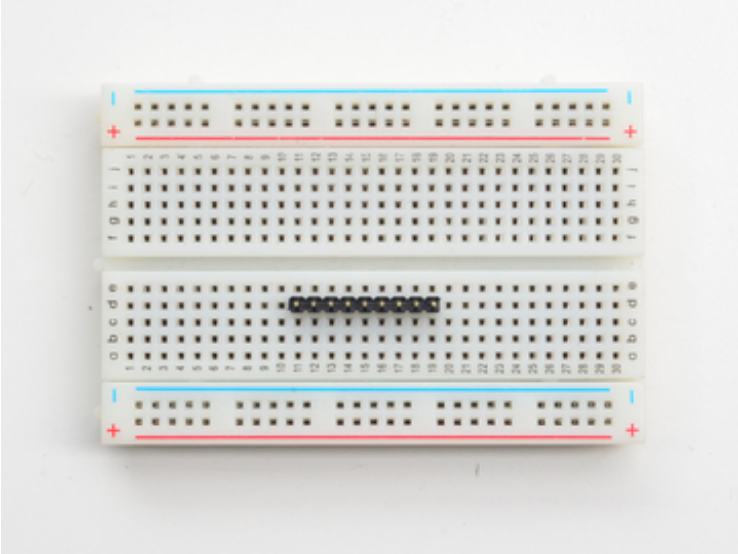

Prepare the header strip:

Cut the strip to length if necessary. It will be easier to solder if you insert it into a breadboard - **long pins down**.

-

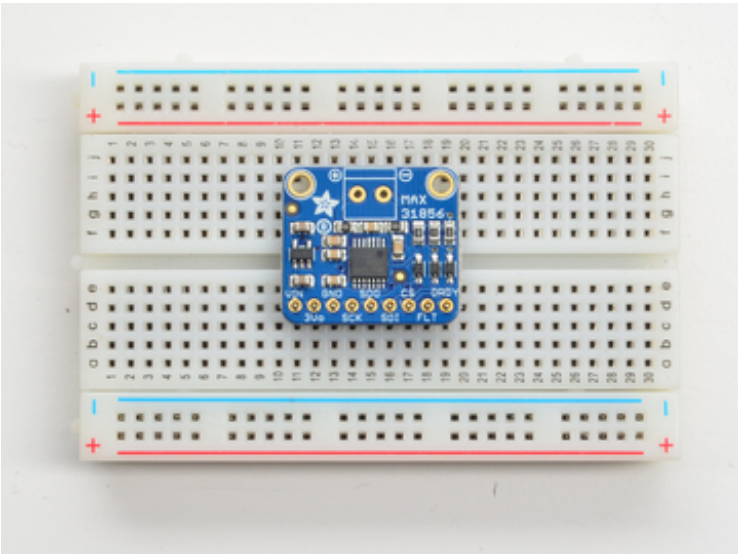

Add the breakout board:

Place the breakout board over the pins so that the short pins poke through the breakout pads

-

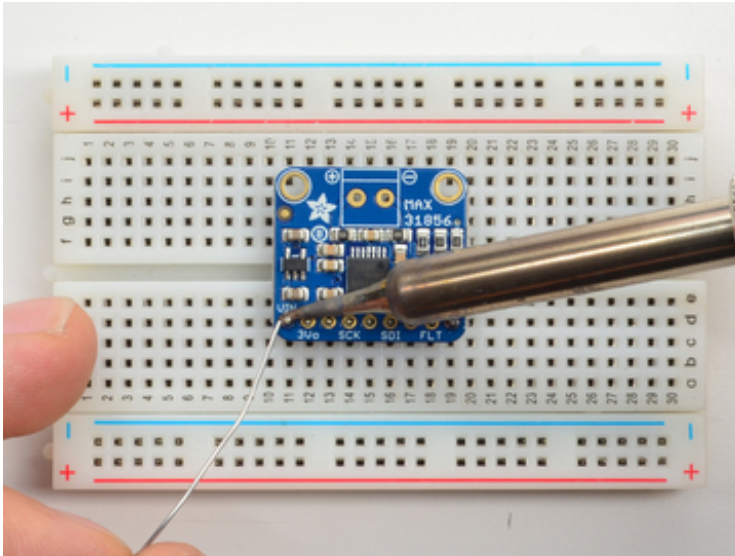

And Solder!

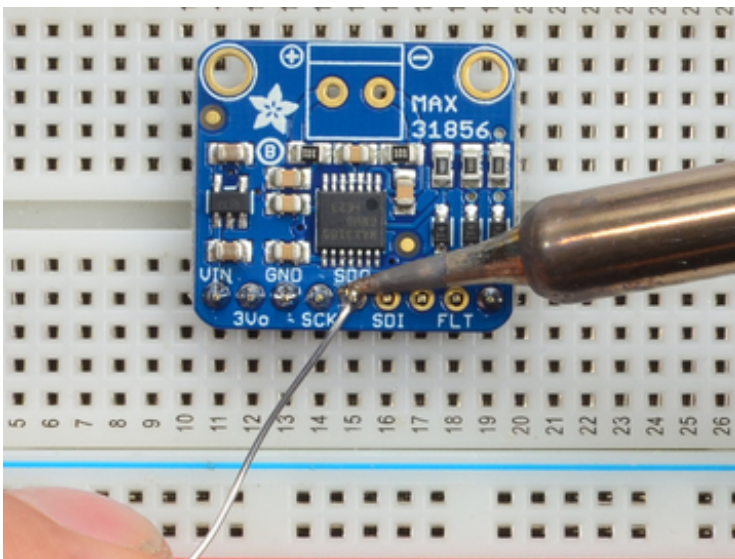

Be sure to solder all 5 pins for reliable electrical contact.

(For tips on soldering, be sure to check out our [Guide to Excellent Soldering](http://adafru.it/aTk) (<http://adafru.it/aTk>))

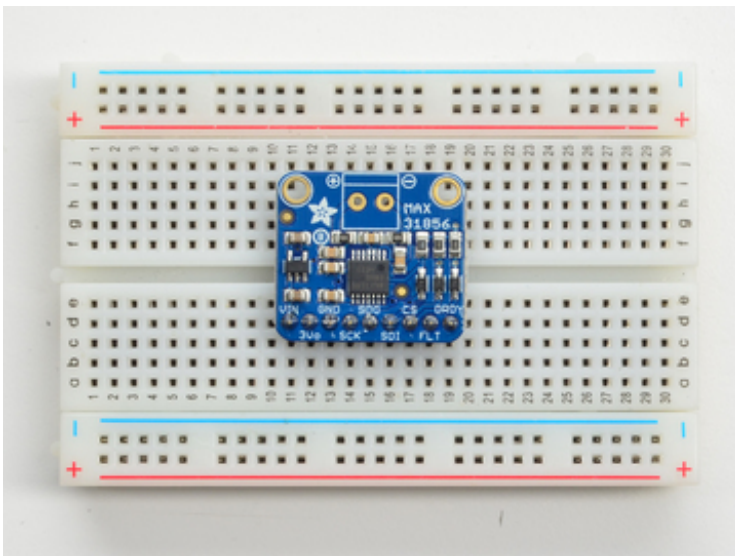

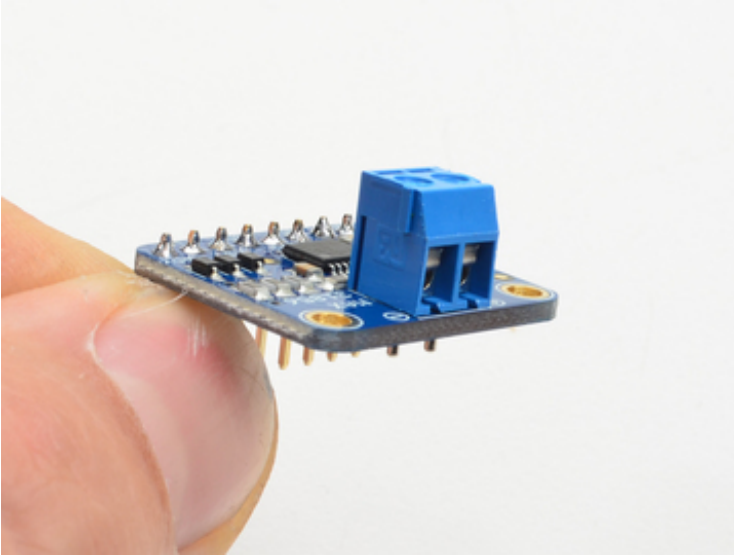

Now you can do the terminal block, this is what you'll use to attach the thermocouple since you cannot solder to thermocouples

The terminal block goes on the top with the open ends pointing out

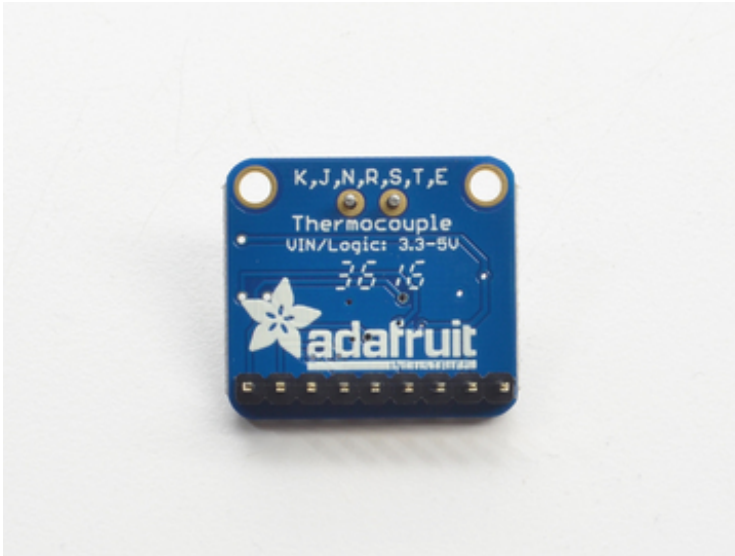

•

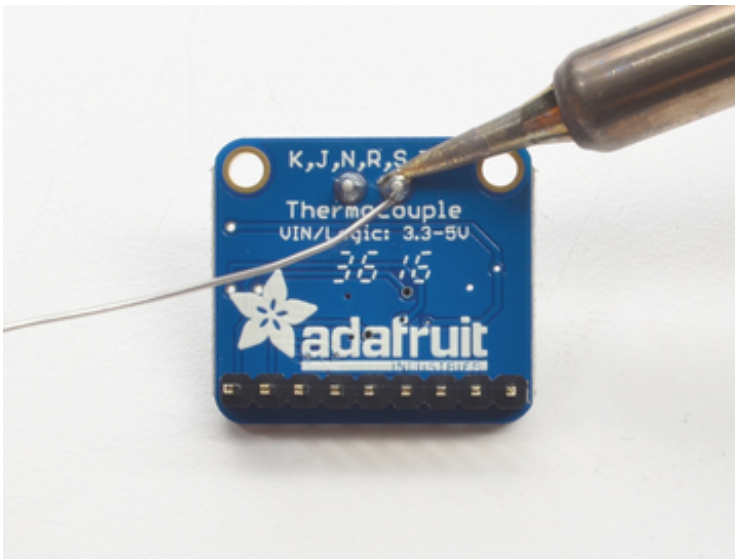

Solder the two pads as you did with the plain header. They're quite large and require a lot of solder

•

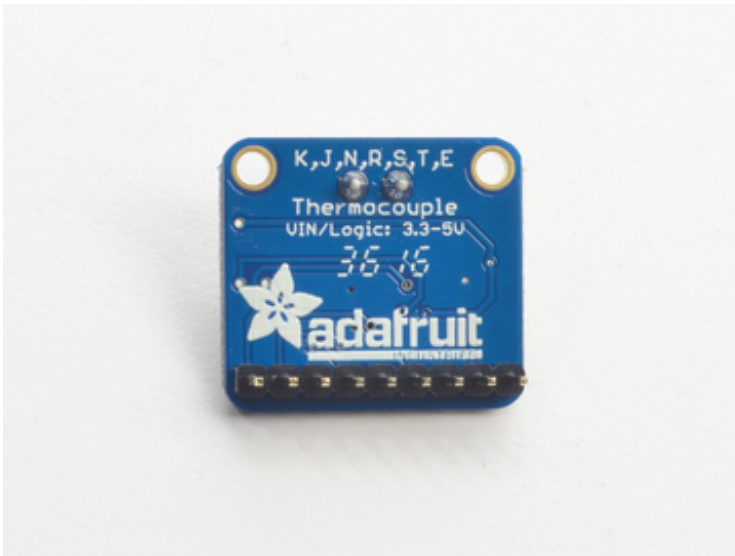

•

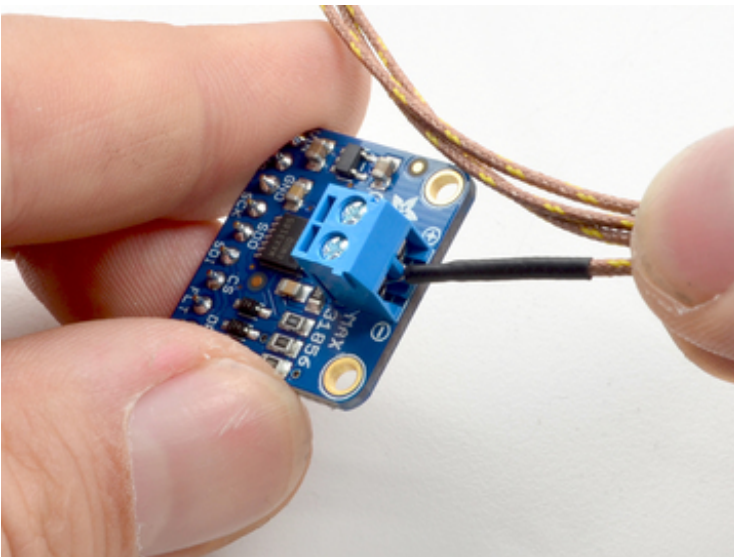

Insert the thermocouple wires and tighten down the clamps with a small Phillips or flat screwdriver

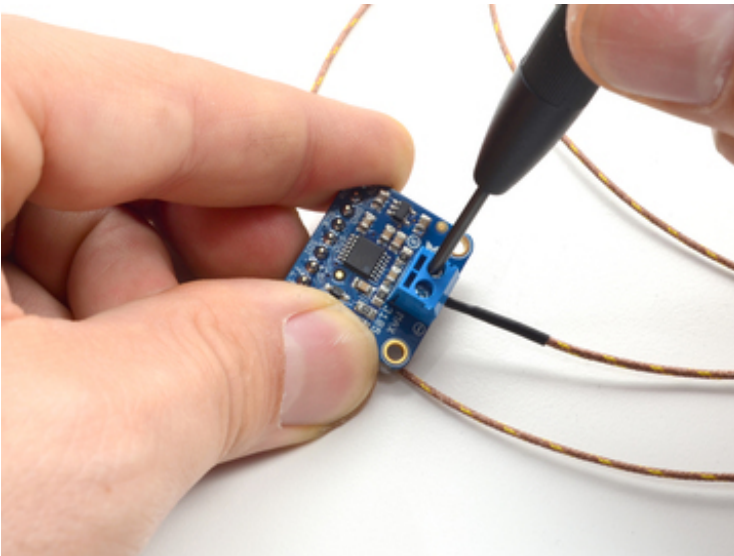



That's it! you are now ready to wire and test

•



Wiring & Test

You can easily wire this breakout to any microcontroller, we'll be using an Arduino. For another kind of microcontroller, as long as you have 4 available pins it is possible to 'bit-bang SPI' or you can use hardware SPI if you like. Just check out the library, then port the code.

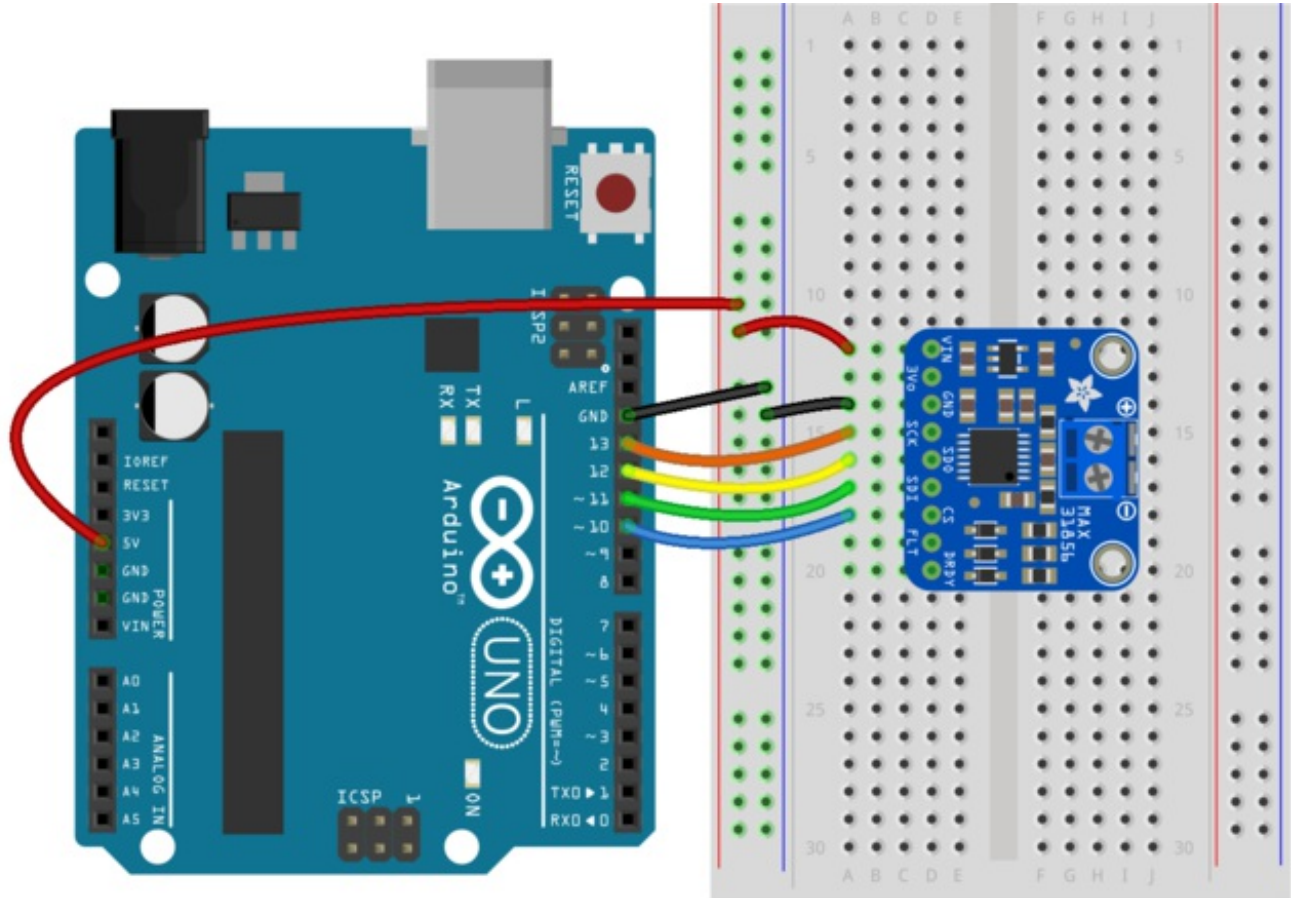

fritzing

[Fritzing diagram.fzz](http://adafruit.com/projects/adafruit-max31856-thermocouple-amplifier)
<http://adafruit.it/rAK>

SPI Wiring

Since this is a SPI-capable sensor, we can use hardware or 'software' SPI. To make wiring identical on all Arduinos, we'll begin with 'software' SPI. The following pins should be used:

- Connect **Vin** to the power supply, 3V or 5V is fine. Use the same voltage that the

microcontroller logic is based off of. For most Arduinos, that is 5V

- Connect **GND** to common power/data ground
- Connect the **SCK** pin to **Digital #13** but any pin can be used later
- Connect the **SDO** pin to **Digital #12** but any pin can be used later
- Connect the **SDI** pin to **Digital #11** but any pin can be used later
- Connect the **CS** pin **Digital #10** but any pin can be used later

Later on, once we get it working, we can adjust the library to use hardware SPI if you desire, or change the pins to other

Download Adafruit_MAX31856 library

To begin reading sensor data, you will need to [download Adafruit_MAX31856 from our github repository \(http://adafru.it/rAL\)](http://adafru.it/rAL). You can do that by visiting the github repo and manually downloading or, easier, just click this button to download the zip

[Download latest Adafruit_MAX31856 library](http://adafru.it/rAM)

<http://adafru.it/rAM>

Rename the uncompressed folder **Adafruit_MAX31856** and check that the **Adafruit_MAX31856** folder contains **Adafruit_MAX31856.cpp** and **Adafruit_MAX31856.h**

Place the **Adafruit_MAX31856** library folder your **arduinofolder/libraries/** folder. You may need to create the **libraries** subfolder if its your first library. Restart the IDE.

We also have a great tutorial on Arduino library installation at:

<http://learn.adafruit.com/adafruit-all-about-arduino-libraries-install-use>

Restart the IDE

Attach Thermocouple

You'll need to attach a thermocouple, for this demo we'll be using a K-type but you can adjust the demo if you do not have a K-type handy!

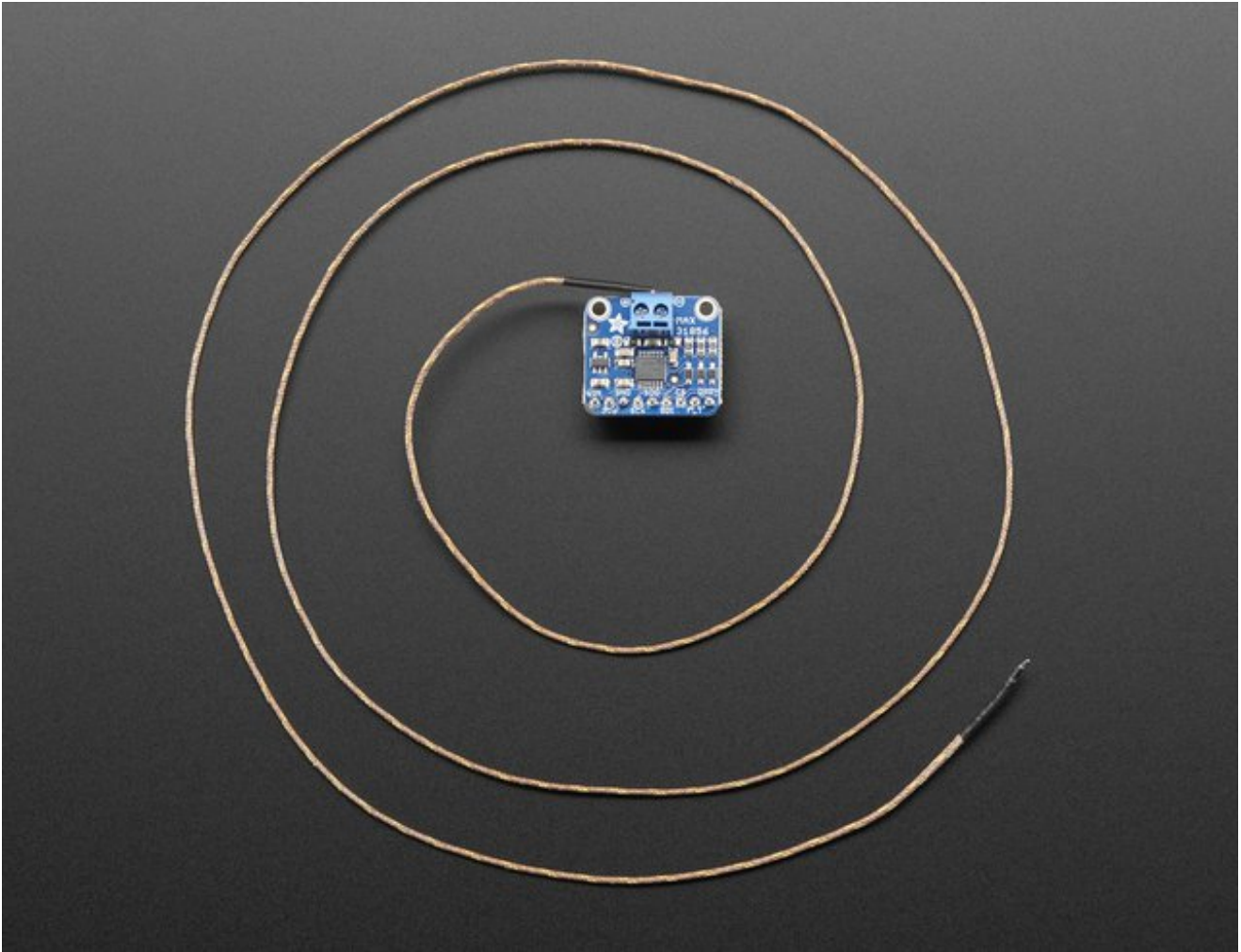

Load Demo

Open up **File->Examples->Adafruit_MAX31856->max31856** and upload to your Arduino wired up to the sensor. Adjust the `max.setThermocoupleType(MAX31856_TCTYPE_K)` line if necessary.

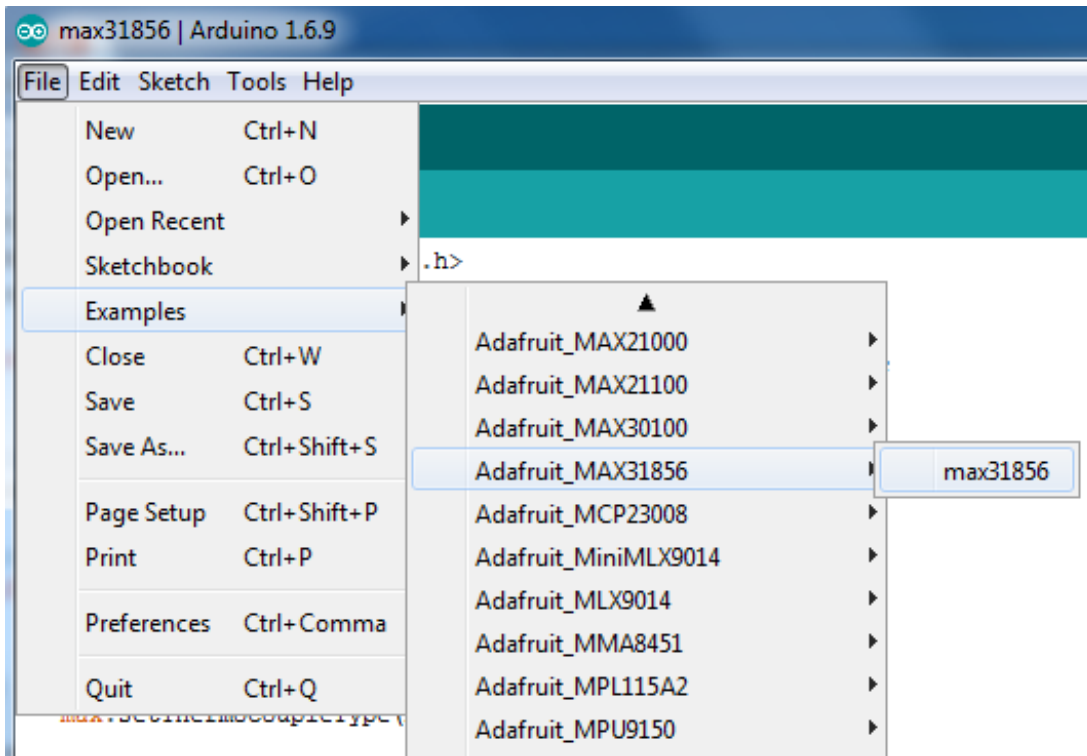

Upload to your Arduino and open up the serial console at 115200 baud to see a print out of the *cold junction temperature* (temperature of the microcontroller chip) and the *thermocouple temperature* (temperature detected at the end of the thermocouple probe)

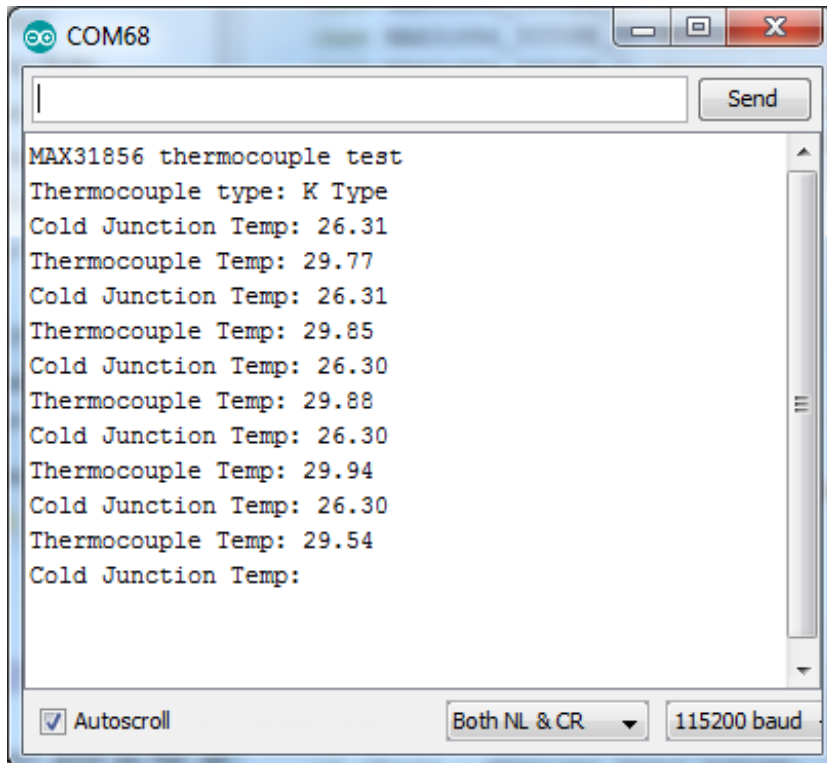

You can also see some of the faults that are detectable by say disconnecting one of the

pins:

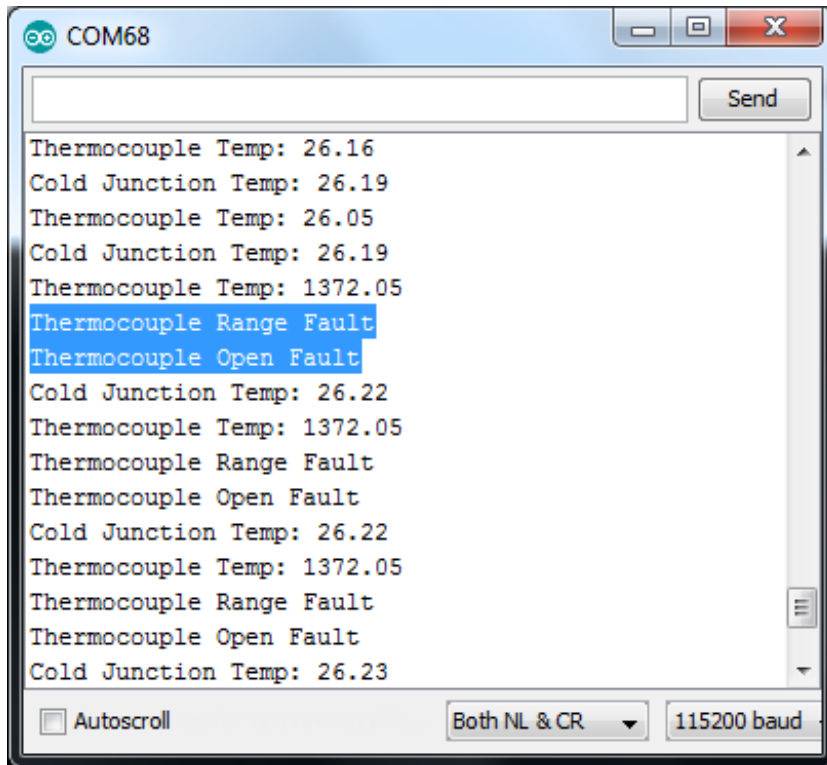

Library Reference

You can start out by creating a MAX31856 object with either software SPI (where all four pins can be any I/O) using

```
// Use software SPI: CS, DI, DO, CLK
Adafruit_MAX31856 max = Adafruit_MAX31856(10, 11, 12, 13);
```

Or you can use hardware SPI. With hardware SPI you *must* use the hardware SPI pins for your Arduino - and each arduino type has different pins! [Check the SPI reference to see what pins to use.](http://adafru.it/d5h) (<http://adafru.it/d5h>)

In this case, you can use any CS pin, but the other three pins are fixed

```
// use hardware SPI, just pass in the CS pin
Adafruit_MAX31856 max = Adafruit_MAX31856(10);
```

Once started, you can initialize the sensor with

```
max.begin()
```

You'll also need to set the thermocouple type, remember there's a lot of options! Set the type with:

```
max.setThermocoupleType(MAX31856_TCTYPE_xxx)
```

Your options for the *TCTYPE* are:

- MAX31856_TCTYPE_B
- MAX31856_TCTYPE_E
- MAX31856_TCTYPE_J
- MAX31856_TCTYPE_K
- MAX31856_TCTYPE_N
- MAX31856_TCTYPE_R
- MAX31856_TCTYPE_S
- MAX31856_TCTYPE_T
- MAX31856_VMODE_G8
- MAX31856_VMODE_G32

The last two are not thermocouple types, they're just 'plain' voltage readings (check the datasheet for more details, we don't use these modes in the library)

If you're ever not sure which mode you're in, query it with

```
max.getThermocoupleType()
```

Once that's set you can read the cold junction temperature, which will return a floating point Celsius reading. This is the temperature detected inside the MAX31856 chip ('ambient' temp)

```
max.readCJTemperature()
```

Or, of course, the temperature at the end/tip of the thermocouple, likewise a floating point #

```
max.readThermocoupleTemperature()
```

Faults

The MAX31856 has a wide-ranging fault mechanism that can alert you via pin or function when something is amiss. Don't forget to test this functionality before relying on it!

You can read faults with

```
max.readFault()
```

Which will return a `uint8_t` type with bits set for each of 8 different fault types. You can test for each one with this set of code:

```
uint8_t fault = max.readFault();  
if (fault) {
```

```
if (fault & MAX31856_FAULT_CJ RANGE) Serial.println("Cold Junction Range Fault");
if (fault & MAX31856_FAULT_TCRANGE) Serial.println("Thermocouple Range Fault");
if (fault & MAX31856_FAULT_CJHIGH) Serial.println("Cold Junction High Fault");
if (fault & MAX31856_FAULT_CJLOW) Serial.println("Cold Junction Low Fault");
if (fault & MAX31856_FAULT_TCHIGH) Serial.println("Thermocouple High Fault");
if (fault & MAX31856_FAULT_TCLOW) Serial.println("Thermocouple Low Fault");
if (fault & MAX31856_FAULT_OVUV) Serial.println("Over/Under Voltage Fault");
if (fault & MAX31856_FAULT_OPEN) Serial.println("Thermocouple Open Fault");
}
```

The last two faults are built in. For the low/high thresholds, you can set those with two functions.

For the cold junction (chip) temp, use:

```
max.setColdJunctionFaultThresholds(lowtemp, hightemp)
```

Where *lowtemp* and *hightemp* range between -127 and +127 Centigrade (the chip wont function down to -127 but that's the lowest number you can put in.

For the thermocouple, use

```
setTempFaultThresholds(lowtemp, hightemp)
```

Where *lowtemp* and *hightemp* are floating point numbers with a range of -4096 to +4096 and a resolution of 0.0625 degrees Centigrade



Downloads

Files

- [Fritzing object in Adafruit Fritzing library \(http://adafru.it/c7M\)](http://adafru.it/c7M)
- [EagleCAD PCB files on GitHub \(http://adafru.it/rAN\)](http://adafru.it/rAN)
- [Library on GitHub \(http://adafru.it/rAL\)](http://adafru.it/rAL)
- [MAX31856 Datasheet \(http://adafru.it/rAO\)](http://adafru.it/rAO)

Schematic

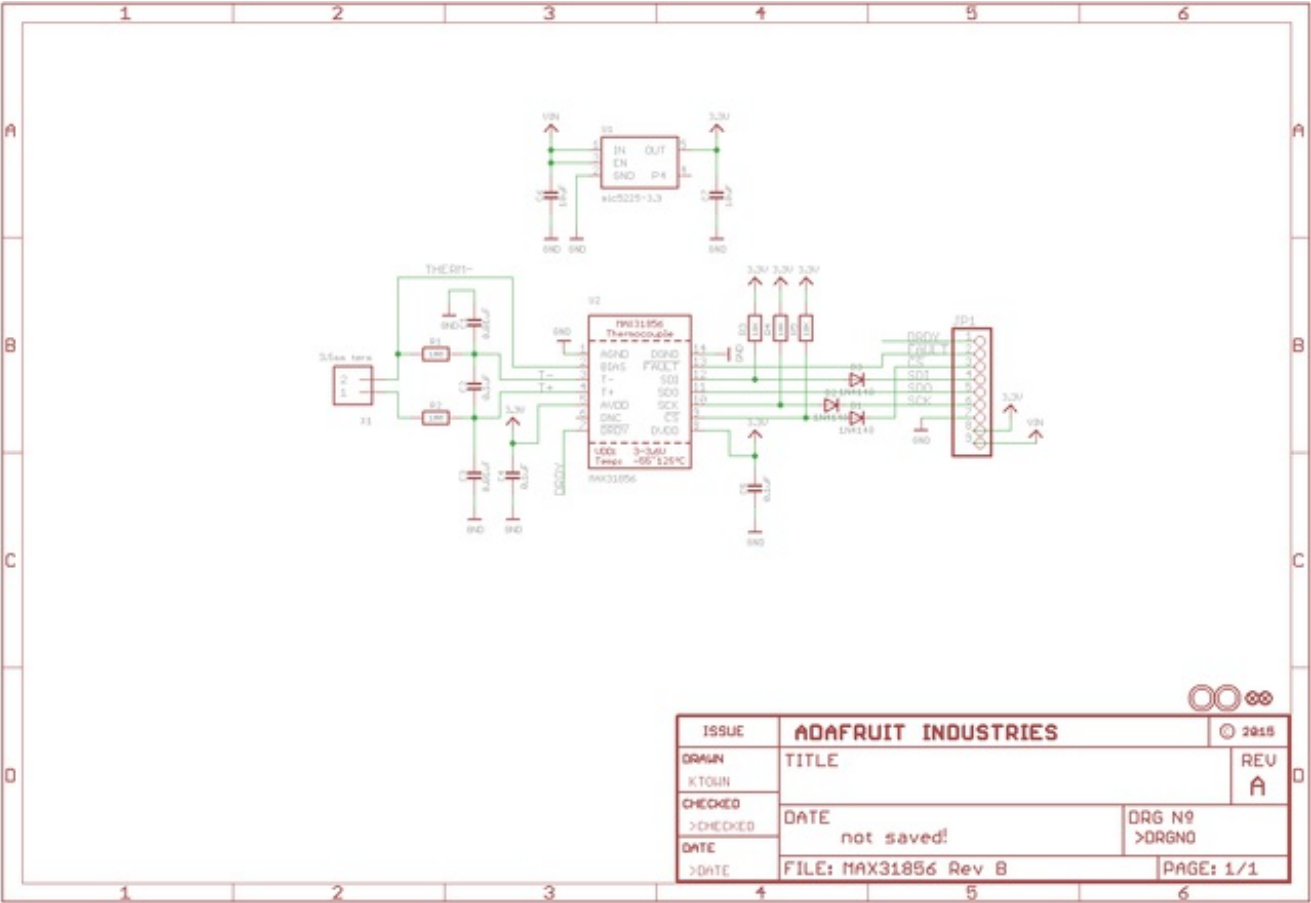

Fabrication Print

