

Rocktech Displays Limited



Module P/N: RK043FN02H-CT

Version: 1.0

Description : 4.3 inch TFT 480*272 pixels with LED
Backlight and capacitive touch panel

TEL: 0086-755-26065260

Fax: 0086-755-26065261

E-mail: Sales@rocktech.com.hk

Web: www.rocktech.com.hk

Revision History

Date	Rev.	Page	Description
2014-3-20	1.0	All	First issue

CONTENTS

- GENERAL FEATURES
- ABSOLUTE MAXIMUM RATINGS
- ELECTRICAL SPECIFICATIONS
- OPTICAL SPECIFICATIONS
- BLOCK DIAGRAM
- PIN DESCRIPTION
- TIMING CHARACTERISTICS
- OUTLINE DIMENSION
- RELIABILITY AND INSPECTION STANDARD
- PRECAUTIONS

1. General Features

Item	Spec	Remark
Display Mode	Normally White transmissive	
Viewing Direction	12 O'CLOCK	
Input Signals	RGB 24 bit	
Outside Dimensions	105.5 (W) x67.2(H) x4.35(D) Max	With CTP
Active Area	95.04mm(W)×53.86mm(H)	
Number of Pixels	480(RGB)×272	
Dot Pitch	0.198mm(H) ×0.198mm(W)	
Pixel Arrangement	RGB Vertical stripes	
Drive IC	OTA5180A	
CTP IC	FT5336GQQ	

2. Absolute Maximum Ratings

The following are maximum values which, if exceeded may cause operation or damage to the unit.

ITEM	Sym.	Min.	Typ.	Max.	Unit	Remark
Power for Circuit Driving	V _{DD}	-0.3	-	4.6	V	
Power for Circuit Logic	V _t	-0.3	-	V _{DD} +0.3	V	
Storage Humidity	H _{ST}	10	-		%RH	At 25±5°C
Storage Temperature	T _{ST}	-30	-	80	°C	
Operating Ambient Humidity	H _{OP}	10	-		%RH	
Operating Ambient temperature	T _{OP}	-20	-	70	°C	

3. Electrical Specification

3.1 Driving TFT LCD Panel

Item	Sym.	Min	Typ.	Max	Unit	Note	
Power for Circuit Driving	VDD	3.0	3.3	3.6	V		
Logic Input Voltage	Low Voltage	V _{IL}	0	-	0.3V _{dd}	V	
	High Voltage	V _{IH}	0.7V _{dd}	-	V _{dd}	V	
Logic Output Voltage	Low Voltage	V _{OL}	0	-	0.2V _{dd}	V	
	High Voltage	V _{OH}	0.8V _{dd}	-	-	V	
Power Consumption	Black Mode	P _b	T.B.D	T.B.D	T.B.D	mW	
	Standby Mode	P _w	T.B.D	T.B.D	T.B.D	mW	

3.2 Driving Backlight

Item	Sym.	Min	Typ.	Max	Unit	Note
Backlight driving voltage	V _F	15	16	17	V	
Backlight driving current	I _F	-	40	-	mA	
Backlight Power Consumption	W _{BL}	-	640	-	mW	
Life Time	-	-	20,000	-		Note 3

Note 1: (Unless specified, the ambient temperature Ta=25°C)

Note 2: The recommended operating conditions refer to a range in which operation of this product is guaranteed. Should this range is exceeded, the operation cannot be guaranteed even if the values may be without the absolute maximum ratings.

Note 3: If LED is driven by high current, high ambient temperature & humidity condition. The life time of LED will be reduced. Operating life means brightness goes down to 50% initial brightness. Typical operating life time is estimated data.

3.3 Driving CTP

Item	Value
Working Voltage	DC 2.8-3.3V
Insulation Resistance	>20M DC25V
Working Current	12.5mA
Response Time	<16ms

4. Optical Specifications

Optical characteristics are determined after the unit has been 'ON' and stable for approximately 30 minutes in a dark environment at 25 °C. The values specified are at an approximate distance 500mm from the LCD surface at a viewing angle of Φ and θ equal to 0°.

Item	Sym.	Values			Unit	Note
		Min.	Typ.	Max.		
1) Contrast Ratio	C/R	400	500	-		FIG.1
2) Module Luminance	L	-	350	-	cd/m ²	With CTP
3) Response time	Tr+Tf	-	20	-	ms	FIG.2
4) Viewing Angle	θ_T	60	70	-	Degree	FIG.3
	θ_B	40	50	-		
	θ_L	60	70	-		
	θ_R	60	70	-		
5) Chromaticity	Wx	0.278	0.298	0.318		
	Wy	0.311	0.331	0.351		
	Rx	-	-	-		
	Ry	-	-	-		
	Gx	-	-	-		
	Gy	-	-	-		
	Bx	-	-	-		
	By	-	-	-		

◆ Measurement System

Notes:

1. Contrast Ratio(CR) is defined mathematically as :

$$\text{Contrast Ratio} = \frac{\text{Surface Luminance with all white pixels}}{\text{Surface Luminance with all black pixels}}$$
2. Surface luminance is the center point across the LCD surface 500mm from the surface with all pixels displaying white. For more information see FIG 1.
3. Response time is the time required for the display to transition from white to black (Rising Time, T_r) and from black to white (Falling Time, T_f). For additional information see FIG 2.
4. Viewing angle is the angle at which the contrast ratio is greater than 10. The angles are determined for the horizontal or x axis and the vertical or y axis with respect to the z axis which is normal to the LCD surface. For more information see FIG 3.

FIG. 1 Optical Characteristic Measurement Equipment and Method

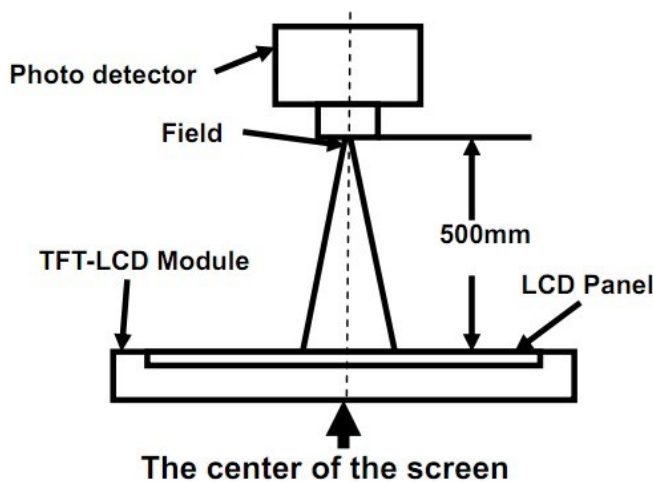

Item	Photo detector	Field
Contrast Ratio	SR-3A	1°
Luminance		
Chromaticity		
Lum Uniformity	BM-7A	2°
Response Time		

FIG. 2 The definition of Response Time

The response time is defined as the following figure and shall be measured by switching the input signal for “black” and “white”.

Response Time = Rising Time(T_r) + Falling Time(T_f)

- Rising Time(T_r) : Full White 90% → Full White 10% Transmittance.
- Falling Time(T_f) : Full White 10% → Full White 90% Transmittance.

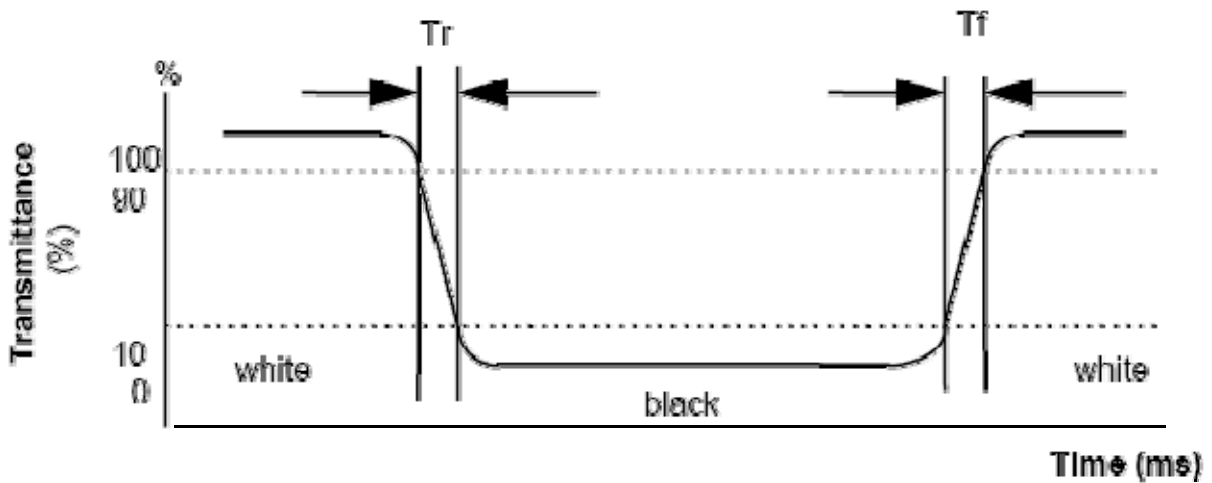
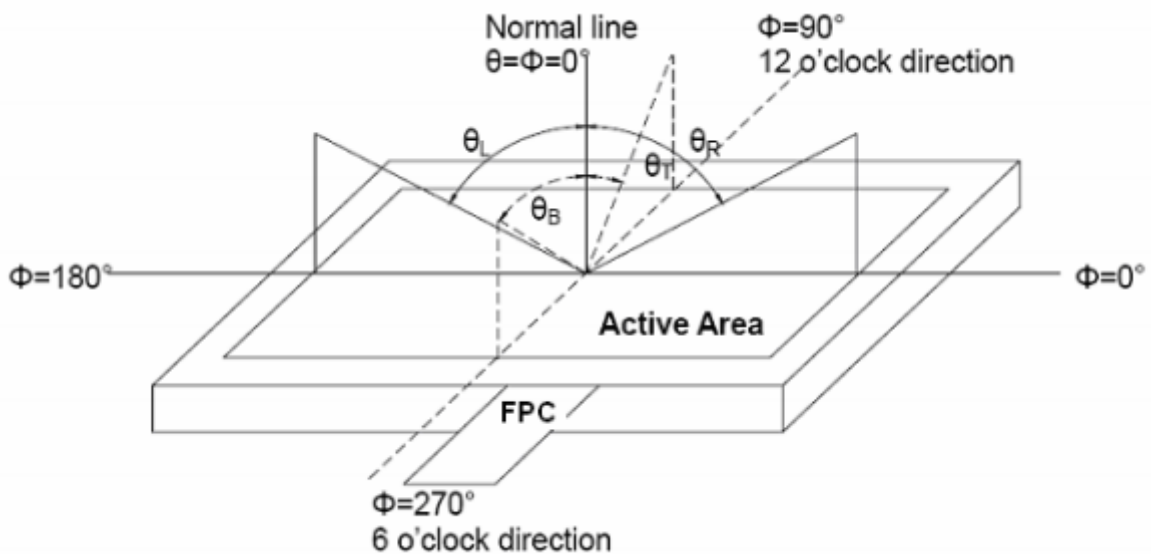
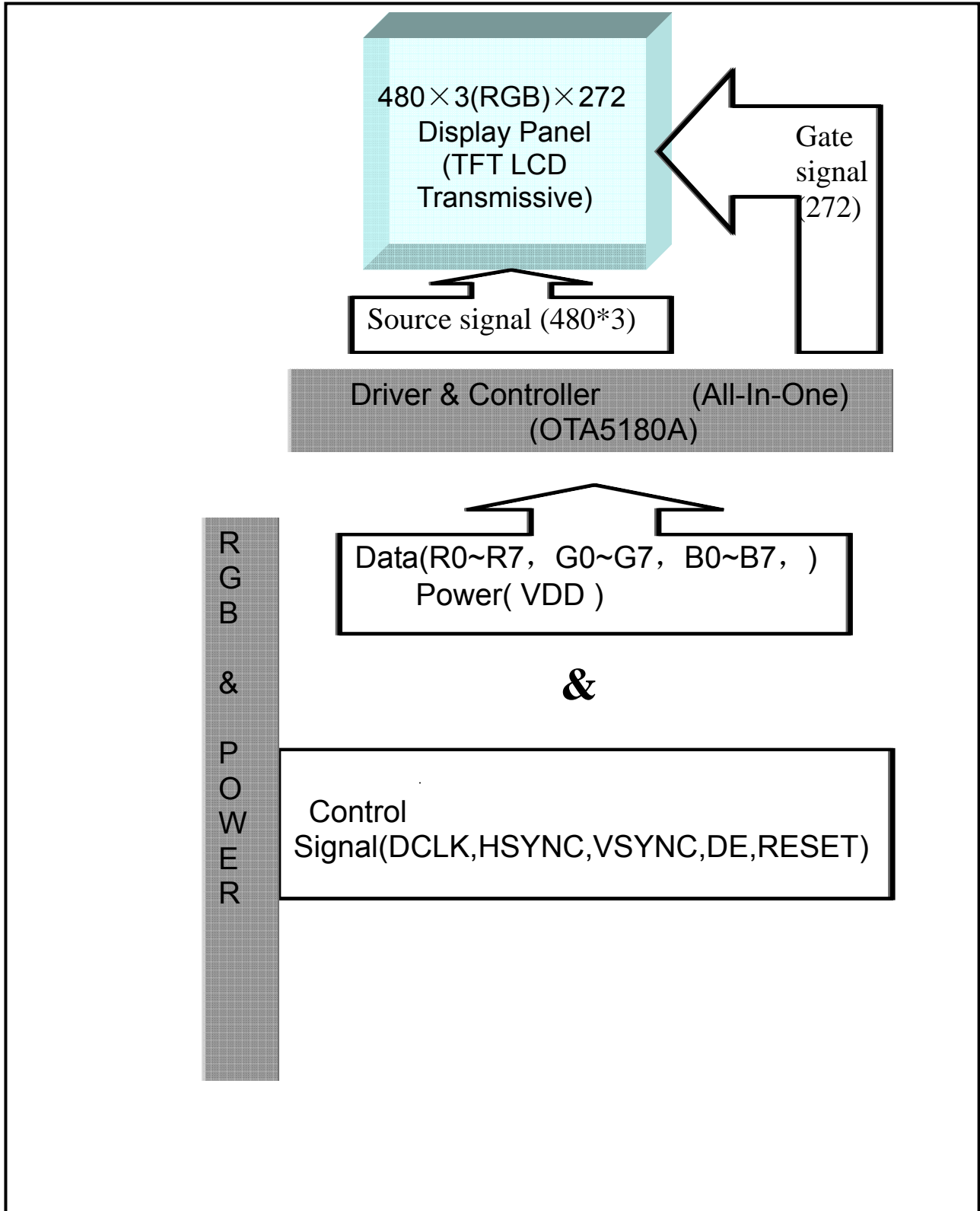

FIG. 3 The definition of Viewing Angle

Use Fig. 1 (Test Procedure) under Measurement System to measure the contrast from the measuring direction specified by the conditions as the following figure.



5. Block Diagram



6.Pin Description

6.1 LCD interface

Item	Symbol	Description
1	K	B/L Power input PIN Cathode
2	A	B/L Power input PIN anode
3	GND	Ground
4	VDD	Power input
5--12	R0--R7	Red Data
13--20	G0--G7	Green Data
21--28	B0--B7	Blue Data
29	GND	Ground
30	CLK	Data clock signal
31	DISP	Standby Mode DISP="1", Normal operation DISP="0", Standby mode.
32	HSYNC	Horizontal synchronizing signal
33	VSYNC	Vertical synchronizing signal
34	DE	Data ENABLE signal
35	NC	NC
36	GND	Ground
37	NC	NC
38	NC	NC
39	NC	NC
40	NC	NC

6.2 CTP interface

Pin	Symbol	Description
1	VDD	Working voltage 2.8V~3.3V
2	Reset	Reset
3	INT	Interrupt
4	SCL	I2C clock
5	SDA	I2C data
6	GND	GND

CTP IC driver source code will be offered separately.

7.3 Parallel RGB Data Format

7.3.1 Parallel RGB Input Timing Table

Item	Symbol	Min.	Typ.	Max.	Unit		
DCLK Frequency	Fclk	5	9	12	MHz		
DCLK Period	Tclk	83	110	200	ns		
Hsync	Period Time	Th	490	531	605	DCLK	
	Display Period	Thdisp		480		DCLK	
	Back Porch	Thbp	8	43		DCLK	By H_BLANKING setting
	Front Porch	Thfp	2	8		DCLK	
	Pulse Width	Thw	1			DCLK	
Vsync	Period Time	Tv	275	288	335	H	
	Display Period	Tvdisp		272		H	
	Back Porch	Tvbp	2	12		H	By V_BLANKING setting
	Front Porch	Tvfp	1	4		H	
	Pulse Width	Tvw	1	10		H	

7.3.2 SYNC Mode Timing Diagram

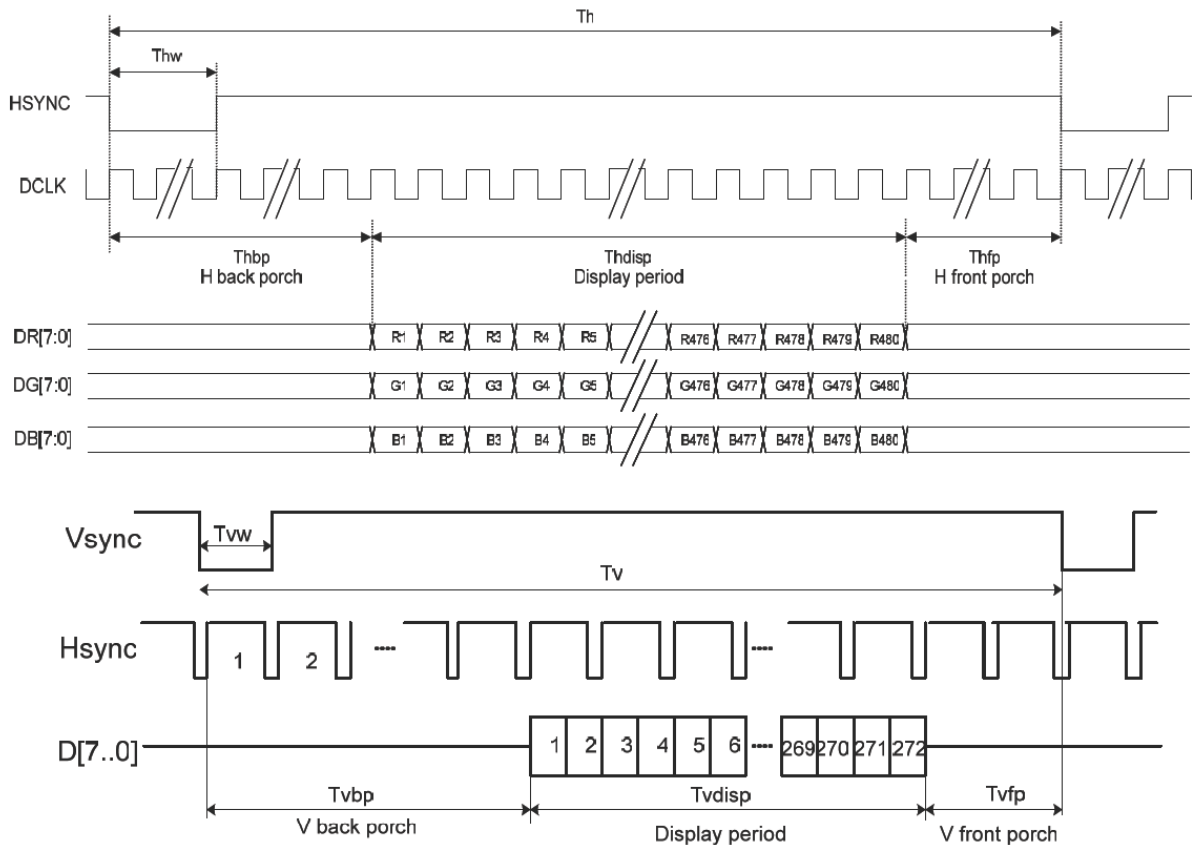

7.3.3 SYNC-DE Mode Timing Diagram

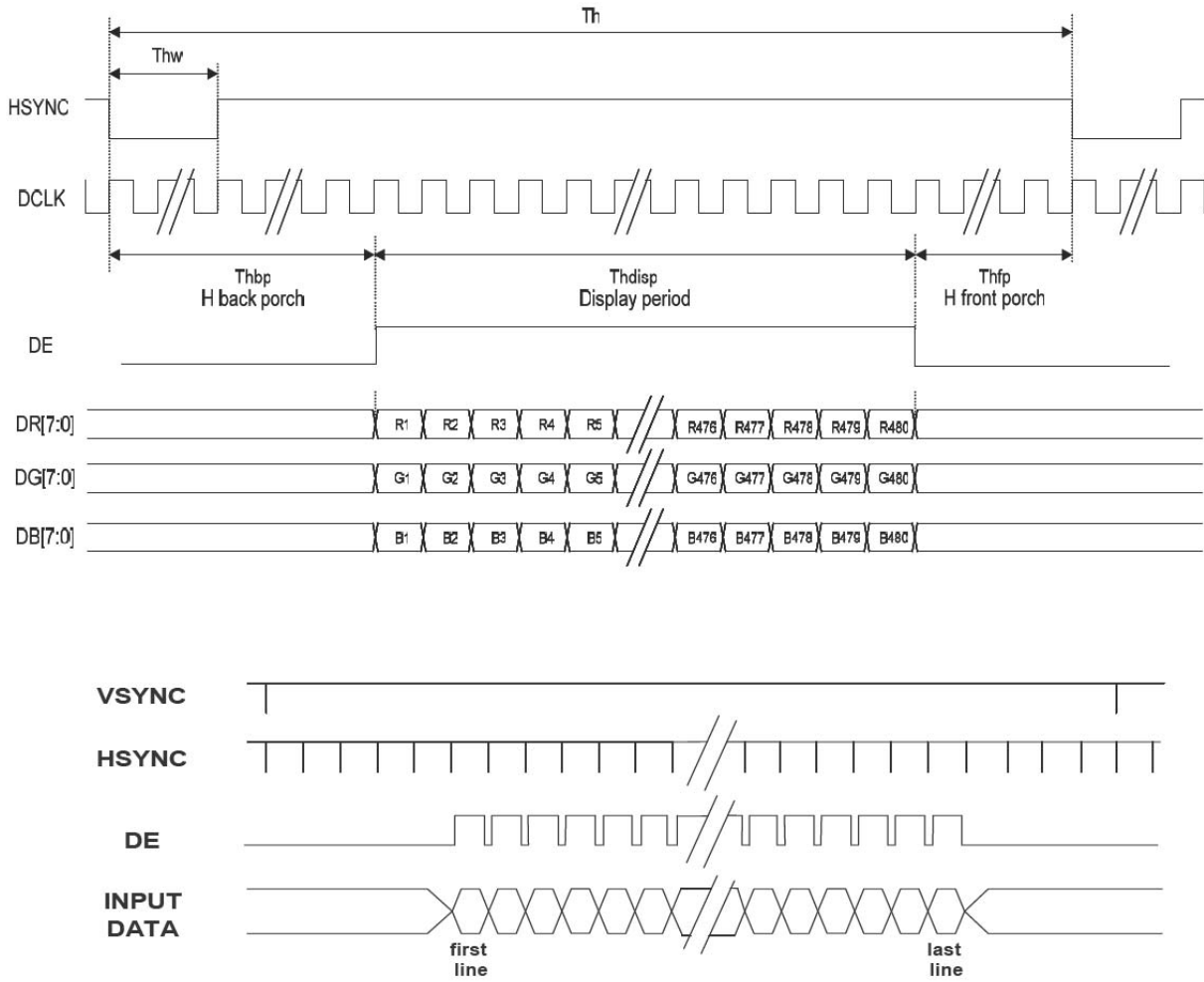

Note: In actual product, input data latched at rising edge of DCLK

7.4 Power on/off Sequence

7.4.1 Power On Sequence

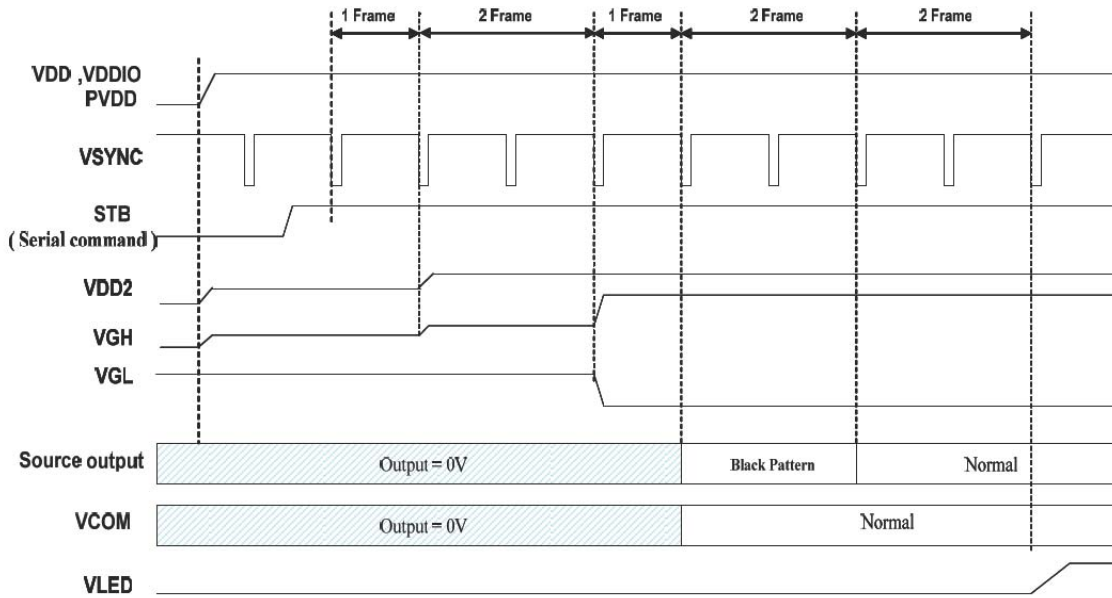

7.4.2 Power Off Sequence

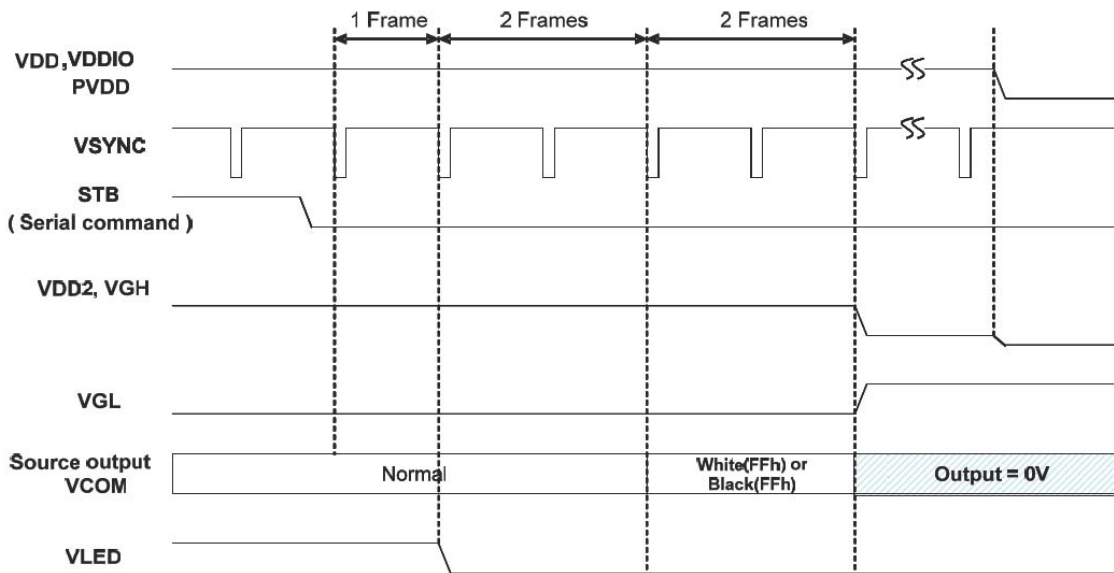

9. Reliability and Inspection Standard

No.	Test Item		Test Conditions	Remark
1	High Temperature	Storage	80°C, 120Hr	Note
		Operation	70°C, 120Hr	Note
2	Low Temperature	Storage	-30°C, 120Hr	Note
		Operation	-20°C, 120Hr	
3	High Temperature and High Humidity		40°C, 90%RH, 120Hr	Note
4	Peeling Off (Storage)		$\geq 500\text{gf/cm}$	Note
5	FPC Bending Test		$\geq 6,000$ times, 2/sec	Note
6	Vibration Test(Storage)		50HZ, 30min, Amplitude: 2 cm, X/Y/Z directions	Note
7	Drop Test		60cm/ 3Corner/ 8Face, 1Cycle	Note

Note:

- 1) The test samples should be applied to only one test item.
- 2) Sample size for each test item is 5~10pcs.
- 3) For Damp Proof Test, pure water(Resistance>1MΩ) should be used.
- 4) In case of malfunction defect caused by ESD damage, if it would be recovered to normal state after resetting, it would be judged as a good part.
- 5) EL evaluation should be excepted from reliability test with humidity and temperature: Some defects such as black spot/blemish can happen by natural chemical reaction with humidity and fluorescence EL has.
- 6) After the reliability test, the test samples should be inspected after 2 hours at least.
- 7) Functional test is OK. Missing segment, shorts, unclear segment, non display, display abnormally, liquid crystal leak are not allowed.
- 8) After testing, the current Idd should be within initial value $\pm 20\%$.
- 9) No low temperature bubbles ,end seal loose and fall, frame rainbow, ACF bubble growing are allowable in the appearance test.

10. PRECAUTIONS FOR USING LCD MODULES

Handling Precautions

- (1) The display panel is made of glass and polarizer. As glass is fragile, it tends to become or chipped during handling especially on the edges. Please avoid dropping or jarring. Do not subject it to a mechanical shock by dropping it or impact.
- (2) If the display panel is damaged and the liquid crystal substance leaks out, be sure not to get any in your mouth. If the substance contacts your skin or clothes, wash it off using soap and water.
- (3) Do not apply excessive force to the display surface or the adjoining areas since this may cause the color tone to vary. Do not touch the display with bare hands. This will stain the display area and degraded insulation between terminals (some cosmetics are determined to the polarizer).
- (4) The polarizer covering the display surface of the LCD module is soft and easily scratched. Handle this polarizer carefully. Do not touch, push or rub the exposed polarizers with anything harder than an HB pencil lead (glass, tweezers, etc.). Do not put or attach anything on the display area to avoid leaving marks on. Condensation on the surface and contact with terminals due to cold will damage, stain or dirty the polarizer. After products are tested at low temperature they must be warmed up in a container before coming in contact with room temperature air.
- (5) If the display surface becomes contaminated, breathe on the surface and gently wipe it with a soft dry cloth. If it is heavily contaminated, moisten cloth with one of the following solvents
 - Isopropyl alcohol
 - Ethyl alcoholDo not scrub hard to avoid damaging the display surface.
- (6) Solvents other than those above-mentioned may damage the polarizer. Especially, do not use the following.
 - Water
 - Ketone
 - Aromatic solventsWipe off saliva or water drops immediately, contact with water over a long period of time may cause deformation or color fading. Avoid contacting oil and fats.
- (7) Exercise care to minimize corrosion of the electrode. Corrosion of the electrodes is accelerated by water droplets, moisture condensation or a current flow in a high-humidity environment.
- (8) Install the LCD Module by using the mounting holes. When mounting the LCD module make sure it is free of twisting, warping and distortion. In particular, do not forcibly pull or bend the I/O cable or the backlight cable.
- (9) Do not attempt to disassemble or process the LCD module.
- (10) NC terminal should be open. Do not connect anything.
- (11) If the logic circuit power is off, do not apply the input signals.
- (12) Since LCM has been assembled and adjusted with a high degree of precision, avoid applying excessive shocks to the module or making any alterations or modifications to it.
 - Do not alter, modify or change the shape of the tab on the metal frame.
 - Do not make extra holes on the printed circuit board, modify its shape or change the positions of components to be attached.
 - Do not damage or modify the pattern writing on the printed circuit board.
 - Absolutely do not modify the zebra rubber strip (conductive rubber) or heat seal

connector.

- Except for soldering the interface, do not make any alterations or modifications with a soldering iron.
- Do not drop, bend or twist LCM.

Storage Precautions

When storing the LCD modules, the following precaution is necessary.

- (1) Store them in a sealed polyethylene bag. If properly sealed, there is no need for the dessicant.
- (2) Store them in a dark place. Do not expose to sunlight or fluorescent light, keep the temperature between 0°C and 35°C.
- (3) The polarizer surface should not come in contact with any other objects. (We advise you to store them in the container in which they were shipped).

Others

Liquid crystals solidify under low temperature (below the storage temperature range) leading to defective orientation or the generation of air bubbles (black or white). Air bubbles may also be generated if the module is subject to a low temperature.

If the LCD modules have been operating for a long time showing the same display patterns, the display patterns may remain on the screen as ghost images and a slight contrast irregularity may also appear. A normal operating status can be regained by suspending use for some time. It should be noted that this phenomenon does not adversely affect performance reliability.

To minimize the performance degradation of the LCD modules resulting from destruction caused by static electricity etc., exercise care to avoid holding the following sections when handling the modules.

- Exposed area of the printed circuit board.
- Terminal electrode sections.